

DrayTek

VigorSwitch P2121

PoE L2 Managed Gigabit Switch

DrayTek



Your reliable networking solutions partner

User's Guide

V1.1

VigorSwitch P2121

PoE L2 Managed Gigabit Switch

User's Guide

Version: 1.1

Firmware Version: V2.5.1

(For future update, please visit DrayTek web site)

Date: December 26, 2019

Copyrights

© All rights reserved. This publication contains information that is protected by copyright. No part may be reproduced, transmitted, transcribed, stored in a retrieval system, or translated into any language without written permission from the copyright holders.

Trademarks

The following trademarks are used in this document:

- Microsoft is a registered trademark of Microsoft Corp.
- Windows, Windows 95, 98, Me, NT, 2000, XP, Vista, 7, 8, 10 and Explorer are trademarks of Microsoft Corp.
- Apple and Mac OS are registered trademarks of Apple Inc.
- Other products may be trademarks or registered trademarks of their respective manufacturers.

Caution

Circuit devices are sensitive to static electricity, which can damage their delicate electronics. Dry weather conditions or walking across a carpeted floor may cause you to acquire a static electrical charge.

To protect your device, always:

- Touch the metal chassis of your computer to ground the static electrical charge before you pick up the circuit device.
- Pick up the device by holding it on the left and right edges only.

Warranty

We warrant to the original end user (purchaser) that the device will be free from any defects in workmanship or materials for a period of one (1) year from the date of purchase from the dealer. Please keep your purchase receipt in a safe place as it serves as proof of date of purchase. During the warranty period, and upon proof of purchase, should the product have indications of failure due to faulty workmanship and/or materials, we will, at our discretion, repair or replace the defective products or components, without charge for either parts or labor, to whatever extent we deem necessary to restore the product to proper operating condition. Any replacement will consist of a new or re-manufactured functionally equivalent product of equal value, and will be offered solely at our discretion. This warranty will not apply if the product is modified, misused, tampered with, damaged by an act of God, or subjected to abnormal working conditions. The warranty does not cover the bundled or licensed software of other vendors. Defects which do not significantly affect the usability of the product will not be covered by the warranty. We reserve the right to revise the manual and online documentation and to make changes from time to time in the contents hereof without obligation to notify any person of such revision or changes.

Be a Registered Owner

Web registration is preferred. You can register your Vigor router via <http://www.DrayTek.com>.

Firmware & Tools Updates

Due to the continuous evolution of DrayTek technology, all routers will be regularly upgraded. Please consult the DrayTek web site for more information on newest firmware, tools and documents.

More update, please visit www.draytek.com.

Table of Contents

Part I Introduction	1
I-1 Introduction	2
I-1-1 Key Features	3
I-1-2 Specifications	3
I-1-3 Packing List	5
I-1-4 LED Indicators and Connectors	5
I-2 Installation	7
I-2-1 Network Connection	7
I-2-2 Rack-Mounted Installation	8
I-2-3 Connection via Console Cable	9
I-2-4 Typical Applications.....	12
I-2-5 Installing Network Cables.....	16
I-2-6 Configuring the Management Agent of Switch.....	16
I-2-7 Managing VigorSwitch P2121 through Ethernet Port.....	16
I-2-8 IP Address Assignment	17
I-3 Accessing Web Page of VigorSwitch	21
I-4 Dashboard.....	22
I-5 Status	23
I-5-1 Port Bandwidth Utilization	23
I-5-2 LLDP Statistics	23
I-5-3 GVRP Statistics.....	24
I-5-4 MLD Snooping Statistics	24
Part II Switch LAN	25
II-1 General Setup	26
II-1-1 Management IP/VLAN.....	26
II-2 Port Setting	28
II-2-1 General Setting.....	28
II-2-2 Protected Ports.....	30
II-3 Mirror.....	31
II-4 Link Aggregation	32
II-4-1 LAG Setting	32
II-4-2 LAG Management	33
II-4-3 LAG Port Setting.....	34
II-4-4 LACP Setting	35
II-4-5 LACP Port Setting	37
II-5 VLAN Management.....	38
II-5-1 Create VLAN	38
II-5-2 Interface Settings.....	39

II-5-3 Voice VLAN	41
II-5-3-1 Properties	41
II-5-3-2 Telephony OUI Setting	42
II-5-3-3 Port Setting	43
II-5-4 MAC VLAN	44
II-5-4-1 MAC Group	44
II-5-4-3 Group Binding	45
II-5-5 Protocol VLAN	47
II-5-5-1 Protocol Group	47
II-5-5-2 Group Binding	48
II-5-6 Surveillance VLAN.....	50
II-5-6-1 Property	50
II-5-6-1 Surveillance OUI.....	51
II-5-7 GVRP	53
II-5-7-1 Property	53
II-5-7-2 Membership	54
II-6 EEE	55
II-7 Multicast	56
II-7-1 Properties	56
II-7-2 IGMP Snooping	57
II-7-2-1 IGMP Setting	57
II-7-2-2 IGMP Querier Setting	59
II-7-2-3 IGMP Static Group	60
II-7-2-4 IGMP Group Table.....	61
II-7-2-5 IGMP Router Table.....	62
II-7-2-6 Forward All	63
II-7-2-7 Throttling	64
II-7-2-8 Filtering Profile	65
II-7-2-9 Filtering Binding	66
II-7-3 MVR.....	68
II-7-3-1 Property	68
II-7-3-2 Port Setting	69
II-7-3-3 Group Address	70
II-7-4 MLD Snooping.....	71
II-7-4-1 MLD Setting	71
II-7-4-2 MLD Static Group	73
II-7-4-3 MLD Group Table.....	75
II-7-4-4 MLD Router Table.....	76
II-7-4-5 Forward All	77
II-7-4-6 Throttling	77
II-7-4-7 Filtering Profile	78
II-7-4-8 Filtering Binding	80
II-8 Jumbo Frame	81
II-9 STP	82
II-9-1 Properties	82
II-9-2 Port Setting	83
II-9-3 Bridge Setting	85
II-9-4 Port Advanced Setting.....	86
II-9-5 Statistics	87
II-9-6 MST Instance	88

II-9-7 MST Port Setting	89
II-10 MAC Address Table.....	91
II-10-1 Static MAC Setting	91
II-10-2 Dynamic Address Setting	92
II-10-3 Dynamic Learned	92
II-11 Blocked Port Recover.....	94
Part III ONVIF Surveillance.....	95
III-1 Topology	96
III-1-1 Status	96
III-2-2 Throughput Threshold	101
III-2 Video	103
III-3 Device Maintenance	104
III-3-1 General.....	104
III-3-2 Network	105
III-3-3 Security.....	107
Part IV Security	109
IV-1 RADIUS	110
IV-2 TACACS+.....	112
IV-3 Management Access Authentication.....	113
IV-3-1 Method Profile	113
IV-3-2 Application Authentication.....	114
IV-4 Management Access Control.....	115
IV-4-1 Management Access Control Profile (ACL)	115
IV-4-2 Management Access Control Entries (ACE).....	116
IV-5 802.1X/MAC Authentication.....	118
IV-5-1 Properties	118
<i>IV-5-1-1 Global Settings</i>	<i>118</i>
<i>IV-5-1-2 Port Authentication Setting.....</i>	<i>119</i>
IV-5-2 Port Control/Settings	120
IV-5-3 MAC-Based Local Account	122
IV-5-4 Authenticated Hosts	123
IV-5-5 Accounting	124
IV-6 Port Security	125
IV-7 Storm Control.....	127
IV-7-1 Properties.....	127
IV-7-2 Port Setting	128
IV-8 DoS	129
IV-8-1 Properties.....	129
IV-8-2 DoS Port Setting	131
IV-9 Dynamic ARP Inspection	132

IV-9-1 Properties.....	132
IV-9-1-1 Global Property Settings.....	132
IV-9-1-2 Per Port Property Settings.....	133
IV-9-2 Statistics.....	134
IV-10 DHCP Snooping.....	135
IV-10-1 Properties.....	135
IV-10-1-1 Global Property Settings.....	135
IV-10-1-2 Per Port Property Settings.....	136
IV-10-2 Statistics.....	137
IV-10-3 Option82 Property.....	138
IV-10-3-1 Global Option82 Property Settings.....	138
IV-10-3-2 Per Port Option82 Property Settings.....	139
IV-10-4 Option82 Circuit ID.....	140
IV-11 IP Source Guard.....	141
IV-11-1 Port Settings.....	141
IV-11-2 IMPV Binding.....	142
IV-12 IP Conflict Prevention.....	144
IV-13 Loop Protection.....	148
Part V ACL Configuration.....	149
V-1 Create ACL.....	150
V-1-1 MAC.....	150
V-1-2 IPv4.....	151
V-1-3 IPv6.....	152
V-2 Create ACE.....	153
V-2-1 MAC.....	153
V-2-2 IPv4.....	154
V-2-3 IPv6.....	157
V-3 ACL Binding.....	159
Part VI QoS Configuration.....	161
VI-1 General.....	162
VI-1-1 Properties.....	162
VI-1-1-1 QoS General Setting.....	162
VI-1-1-2 Trust Ports.....	163
VI-1-2 Port Settings.....	164
VI-1-3 Queue Settings.....	165
VI-1-4 CoS Mapping.....	166
VI-1-5 DSCP Mapping.....	167
VI-1-6 IP Precedence Mapping.....	168
VI-2 Bandwidth.....	169
VI-2-1 Ingress Rate Limit.....	169
VI-2-2 Egress Shaping Rate.....	170
VI-2-3 Egress Shaping Per Queue.....	171

Part VII PoE Configuration	173
VII-1 Properties	174
VII-2 Status	175
VII-3 Schedule	176
VII-3-1 Schedule Profile	176
VII-3-2 Port Scheduling	177
Part VIII System Maintenance	179
VIII-1 TR-069	180
VIII-2 OpenVPN	182
VIII-3 Webhook	183
VIII-4 LLDP	184
VIII-4-1 Properties	184
VIII-4-2 LLDP Port Setting	185
VIII-4-3 LLDP Local Device	186
VIII-4-4 MED Network Policy	187
VIII-4-5 LLDP MED Port Settings	188
VIII-4-6 LLDP Remote Device	189
VIII-4-7 LLDP Overloading	190
VIII-5 SNMP	191
VIII-5-1 View	192
VIII-5-2 Group	193
VIII-5-3 Community	194
VIII-5-4 User	195
VIII-5-5 Engine ID	197
VIII-5-5-1 Local Engine ID	197
VIII-5-5-2 Remote Engine ID	198
VIII-5-6 Trap Event	199
VIII-5-7 Notification	200
VIII-6 Access Manager	202
VIII-7 Time and Date	203
VIII-7-1 System Time Zone	203
VIII-7-2 Time	204
VIII-8 Backup Manager	205
VIII-9 Upgrade Manager	206
VIII-10 Firmware Information	207
VIII-11 Account Manager	208
VIII-12 Factory Default	209
VIII-13 Reboot Switch	210
Part IX Diagnostics	211
IX-1 Device Check	212

IX-2 Cable Diagnostics.....	213
IX-3 Ping Test.....	214
IX-4 SysLog.....	215
IX-4-1 SysLog Explorer.....	215
IX-4-2 SysLog Settings.....	216
IX-4-2-1 SysLog Service.....	216
IX-4-2-2 Local SysLog.....	217
IX-4-2-3 Remote SysLog.....	218
IX-4-2-4 SysLog Mail.....	219
Part X Mail Alert	221
X-1 Alert Setting.....	222
Part XI Telnet Commands.....	225
XI-1 Accessing Telnet of VigorSwitch.....	226
XI-2 Available Commands.....	228
XI-2-1 Clear Configuration.....	228
XI-2-2 Clock Configuration.....	237
XI-2-3 Configure Configuration.....	238
XI-2-4 Copy Configuration.....	325
XI-2-5 Delete Configuration.....	326
XI-2-6 Disable Configuration.....	327
XI-2-7 End Configuration.....	327
XI-2-8 Exit Configuration.....	327
XI-2-9 Hardware-Monitor Configuration.....	328
XI-2-10 Ping Configuration.....	328
XI-2-11 Reboot Configuration.....	329
XI-2-12 Renew Configuration.....	329
XI-2-13 Restore-defaults Configuration.....	329
XI-2-14 Save Configuration.....	330
XI-2-15 Show Configuration.....	330
XI-2-16 SSL Configuration.....	331
XI-2-17 Terminal Configuration.....	332
XI-2-18 Traceroute Configuration.....	332
XI-2-19 UDLD Configuration.....	333
Appendix: Reference.....	335
A-1 What's the Ethernet.....	335
A-2 Media Access Control (MAC).....	338
A-3 Flow Control.....	342
Index	345

Part I Introduction

I-1 Introduction

VigorSwitch P2121, 8 Ports + 4 Combo UTP/SFP Ports PoE L2 Managed Gigabit Switch, is a standard switch that meets all IEEE 802.3/u/x/z Gigabit, Fast Ethernet specifications. The switch has 8 10/100/1000Mbps TP ports. It supports telnet, http, https, SSH and SNMP interface for switch management. The network administrator can login the switch to monitor, configure and control each port's activity. In addition, the switch implements the QoS (Quality of Service), VLAN, and Trunking. It is suitable for office application.

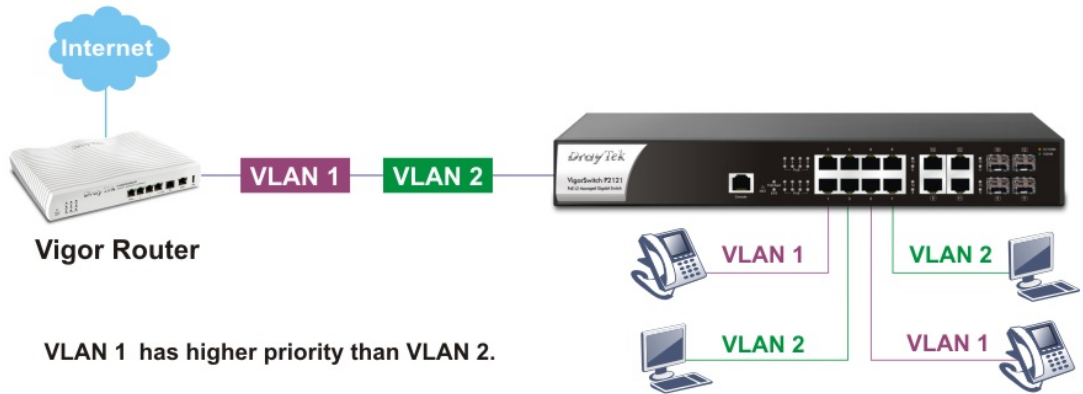

Vigor switch supports IEEE 802.3az, Energy-Efficient Ethernet, and provides power saving feature. It can efficiently save the switch power with auto detect the client idle and cable length to provide different power.

1000Mbps SFP Fiber port fully complies with all IEEE 802.3z and 1000Base-SX/LX standards.

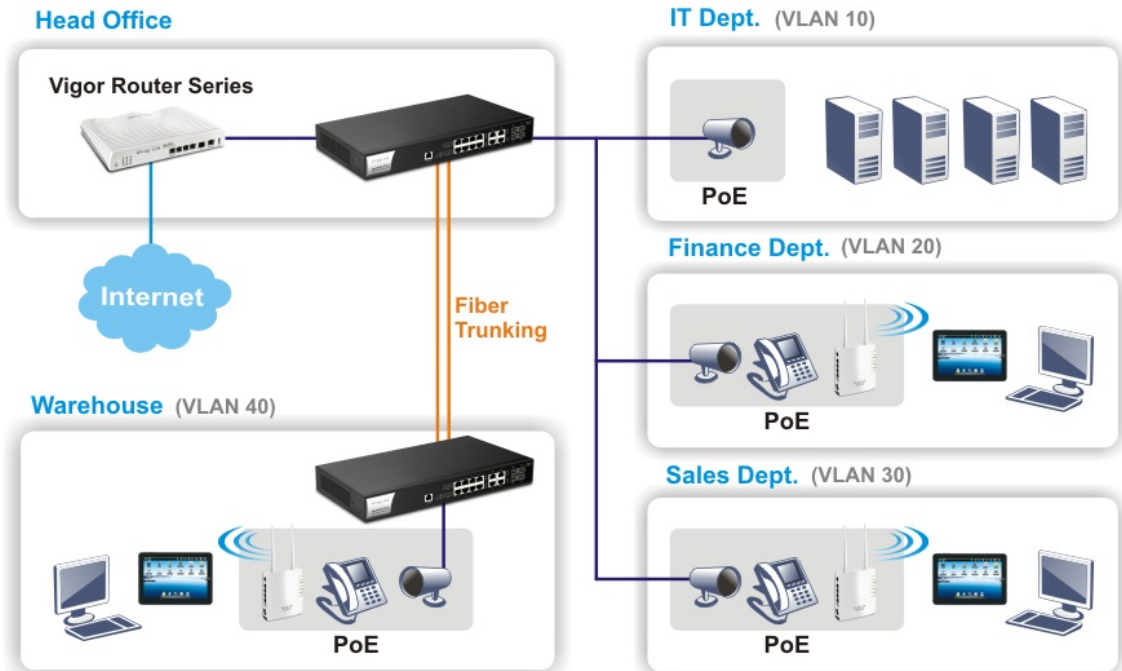

I-1-1 Key Features

Below shows key features of this device:

QoS

The switch offers powerful QoS function. This function supports 802.1p VLAN tag priority and DSCP on Layer 3 of network framework.

VLAN

Support 12 active VLANs and VLAN ID 1~4094.

Port Trunking

Allows one or more links to be aggregated together to form a Link Aggregation Group by the static setting.

Power Saving

The Power saving using the IEEE 802.3az, Energy-Efficient Ethernet to detect the client idle and cable length automatically and provides the different power. It could efficient to save the switch power and reduce the power consumption.

I-1-2 Specifications

The VigorSwitch P2121, a standalone off-the-shelf switch, provides the comprehensive features listed below for users to perform system network administration and efficiently and securely serve your network.

Hardware

- ❖ 8 10/100/1000Mbps Auto-negotiation Gigabit Ethernet TP ports with PoE+
- ❖ Jumbo frame support 9KB
- ❖ 4 UTP/SFP Combo Ethernet Ports
- ❖ Programmable classifier for QoS (Layer 2/Layer 3)
- ❖ 8K MAC address and support VLAN ID(1~4094)
- ❖ Per-port shaping, policing, and Broadcast Storm Control
- ❖ Power Saving with IEEE 802.3az, Energy-Efficient Ethernet
- ❖ Full-duplex flow control (IEEE802.3x) and half-duplex backpressure
- ❖ Extensive front-panel diagnostic LEDs; Power, System, PoE fail and PoE/link activity
- ❖ Hardware reset button for resetting configuration to factory default by pressing over 5 seconds

Management

- ❖ Supports per port traffic monitoring counters
- ❖ Supports a snapshot of the system Information when you login
- ❖ Supports port mirror function

- ❖ Supports the static trunk function
- ❖ Supports 802.1Q VLAN
- ❖ Supports user management and limits three users to login
- ❖ Maximal packet length can be up to 9600 bytes for jumbo frame application
- ❖ Supports Broadcasting Suppression to avoid network suspended or crashed
- ❖ Supports to send the trap event while monitored events happened
- ❖ Supports default configuration which can be restored to overwrite the current configuration which is working on via Web UI and Reset button of the switch
- ❖ Supports on-line plug/unplug SFP modules
- ❖ Supports Quality of Service (QoS) for real time applications based on the information taken from Layer 2 to Layer 3
- ❖ Built-in web-based management and CLI management, providing a more convenient UI for the user

I-1-3 Packing List

Before you start installing the switch, verify that the package contains the following:

- ❖ VigorSwitch P2121
- ❖ AC Power Cord
- ❖ Quick Start Guide
- ❖ Rubber feet
- ❖ Rack mount kit
- ❖ Console Cable

Please notify your sales representative immediately if any of the aforementioned items is missing or damaged.

I-1-4 LED Indicators and Connectors

Before you use the Vigor device, please get acquainted with the LED indicators and connectors first. There are 8 Ethernet ports and SFP ports on the front panel of the switch. LED display area, locating on the front panel, contains an ACT, Power LED and ports working status of the switch.

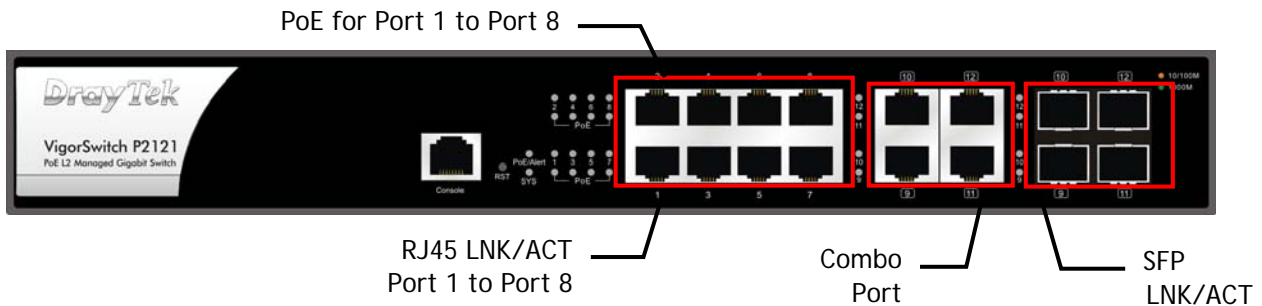

LED	Status	Explanation
PoE/Alert	On (Green)	Devices connected over the PoE maximum power budget.
	Blinking (Green)	More than 80% of maximum power budget is supplied for PoE device(s).
	Off	Devices connected within the PoE maximum power budget.
SYS	On (Green)	The switch finishes system booting and the system is ready.
	Blinking (Green)	The switch is powered on and starts system booting.
	Off	The power is off or the system is not ready / malfunctioning.
PoE 1~8	On (Green)	The port is supplied with PoE power.
	Off	No PoE power is supplied on the port.
RJ 45	On (Green)	The device is connected with 1000Mbps.

LNK/ACT Port 1 ~ 8	On (Amber)	The device is connected with 10/100Mbps.
	Blinking	The system is sending or receiving data through the port.
	Off	The port is disconnected or the link is failed.
Combo for Port 9 ~ 12 (RJ 45 LNK/ACT)	On (Green)	The device is connected with 1000Mbps.
	On (Amber)	The device is connected with 10/100Mbps.
	Blinking	The system is sending or receiving data through the port.
	Off	The port is disconnected or the link is failed.
SFP LNK/ACT	On (Green)	The device is connected with 1000Mbps.
	On (Amber)	The device is connected with 10/100Mbps.
	Blinking	The system is sending or receiving data through the port.
	Off	The port is disconnected or the link is failed.

Connector Explanation

Interface	Description
Console	Used to perform telnet command control.
RST	<p>Factory reset button.</p> <ul style="list-style-type: none"> ● Press it to reboot the system. (<5 seconds) The PoE/Alert and SYS LEDs will blink too. ● Press it to reset the system with factory default settings. (5~20 seconds) <p>The PoE/Alert and SYS LEDs will be off if RST button is pressed between 5 seconds and 10 seconds.</p>
RJ 45 LNK/ACT Port 1 ~ 8 PoE for Port 1 ~ 8	Port 1 to Port 8 can be used for Ethernet connection and PoE connection, depending on the device connected.
SFP LNK/ACT Port 9 ~ 12	Port 9 to Port 12 are used for fiber connection.
	Power inlet for AC input (100~240V/AC, 50/60Hz).

Note:

Power Output -

- IEEE 802.3af Max. 15.4W Output Supported
- IEEE 802.3at Max. 30W Output Supported

PoE Power Budget--

- 140 Watts

I-2 Installation

I-2-1 Network Connection

- Use a Cat. 5e twisted-pair cable to connect a PoE device to the port (1~8) of this switch.
- The switch will supply power to PoE Device over the twisted-pair cable.
- Please note that Power Device must comply with IEEE 802.3af/at.
- Other PCs, servers and network devices can be connected to the switch using a standard 'straight through' twisted pair cable.



I-2-2 Rack-Mounted Installation

The switch can be installed easily by using **rack mount kit**.

1. Attach the brackets to the chassis of a 19- or a 23-inch rack. The second bracket attaches the other side of the chassis as above procedure.

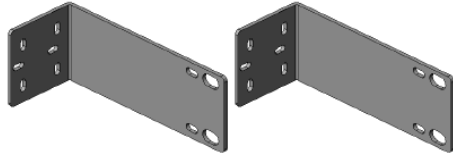

2. After the bracket installation, the VigorSwitch's chassis can be installed in a rack by using four screws for each side of the rack.



I-2-3 Connection via Console Cable

You can perform debugging, configuration and firmware upgrade, through the console connection.

To connect VigorSwitch to a PC via console cable, please

1. Connect the RJ45 connector of console cable to the console port on Vigor device.
2. Connect the DB9 connector of the console cable to the RS232 port on the PC.

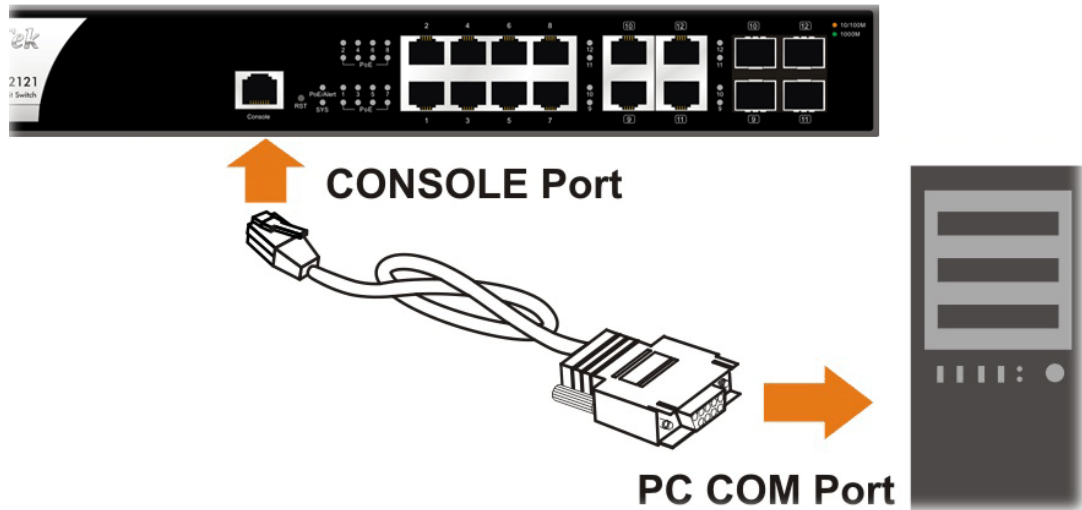

To connect VigorSwitch to a notebook, please

1. Connect the DB9 connector of the console cable to the DB9 connector of USB to RS232 cable first.
2. Connect the RJ45 connector of console cable into the Console Port of the switch.
3. Connect the USB connector to the USB port of the notebook.

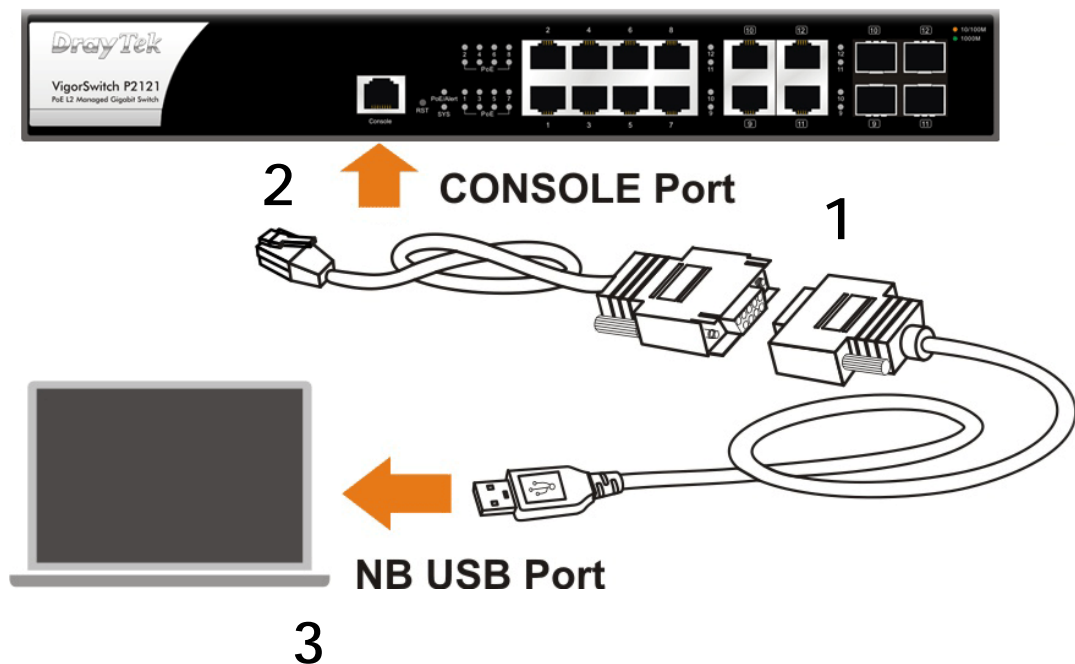

Console Port Configuration

1. Open Hyper Terminal on the PC.
2. Open the following dialog to configure COM1 Properties as

Baud rate: 115200
Data bits: 8
Stop bits: 1
Parity: None
Flow control: None

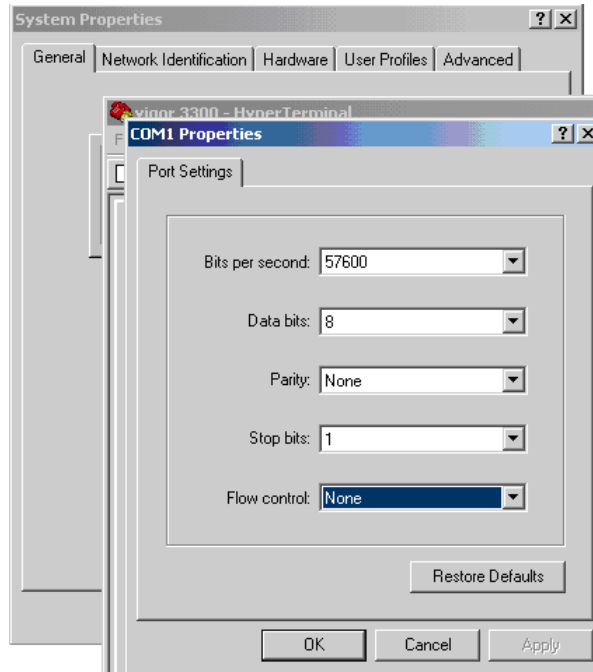

Or, you can make configuration via PuTTY utility.

1. Make sure the PuTTY utility has been installed on your PC. Execute PuTTY.
2. Configure the settings as the following figures. The default settings of the console port are:

Baud rate: 115200
Data bits: 8
Stop bits: 1
Parity: None
Flow control: None

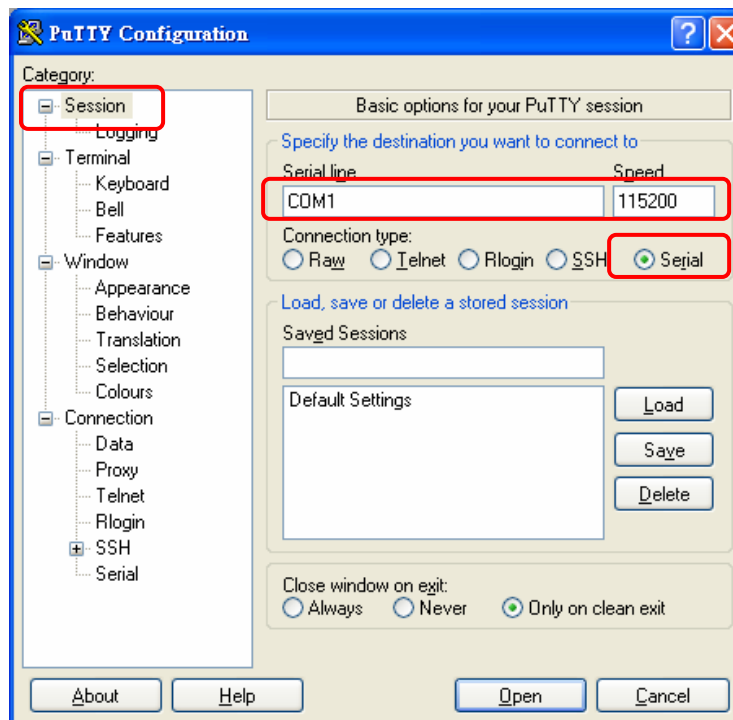
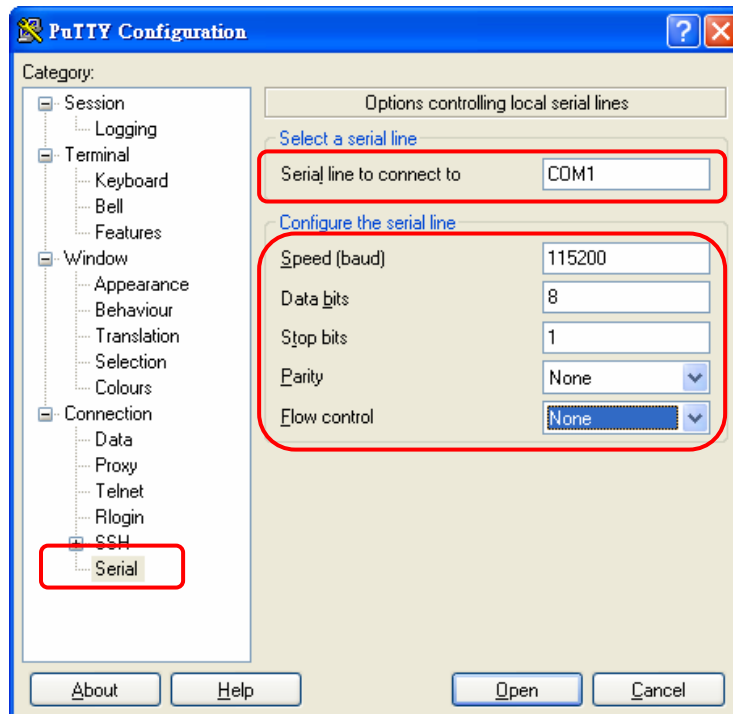

3. Click **Open**. The default login is:

Username: admin

Password: admin

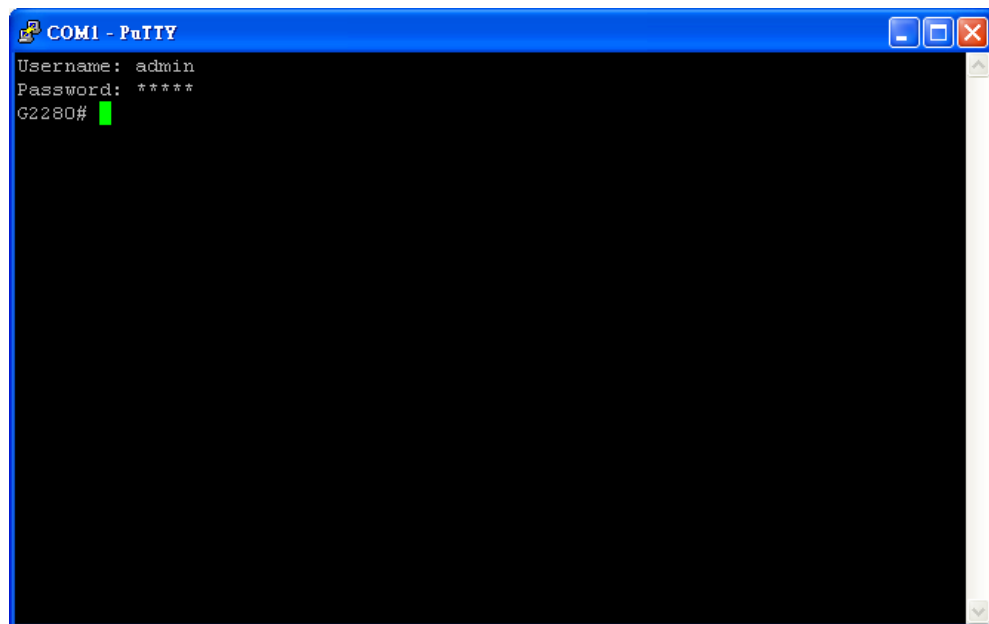

I-2-4 Typical Applications

The VigorSwitch implements 8 Gigabit Ethernet TP ports with auto MDIX and four slots for the removable module supporting comprehensive fiber types of connection, including LC and BiDi-LC SFP modules. The switch is suitable for the following applications:

Case 1: All switch ports are in the same local area network.

Every port can access each other. (*The switch image is sample only.)



If VLAN is enabled and configured, each node in the network that can communicate each other directly is bounded in the same VLAN area.

Here VLAN area is defined by what VLAN you are using. The switch supports both port-based VLAN and tag-based VLAN. They are different in practical deployment, especially in physical location. The following diagram shows how it works and what the difference they are.

Case 2: The same VLAN members can be at different switches with the same VID

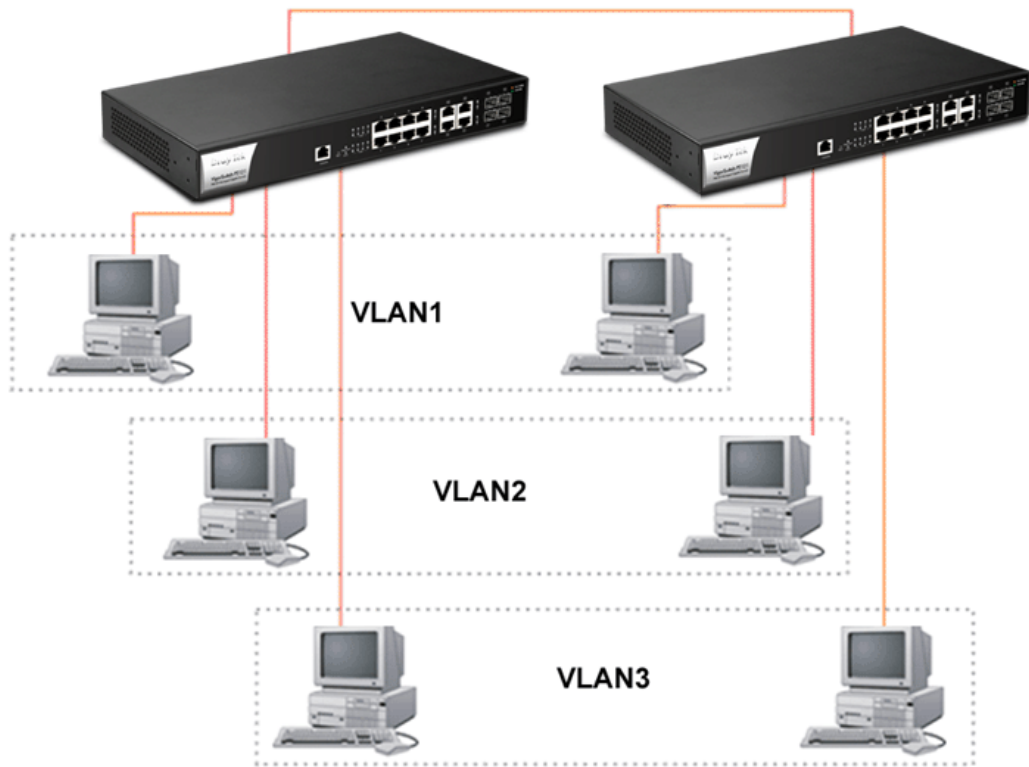

Case 3: Desktop Installation

1. Install the switch on a level surface that can support the weight of the unit and the relevant components.
2. Plug the switch with the female end of the provided power cord and plug the male end to the power outlet.

Case 4: Rack-mount Installation

The switch may be standalone, or mounted in a rack. Rack mounting facilitates to an orderly installation when you are going to install series of networking devices.

Procedures to Rack-mount the switch:

1. Disconnect all the cables from the switch before continuing.
2. Place the unit the right way up on a hard, flat surface with the front facing you.
3. Locate a mounting bracket over the mounting holes on one side of the unit.
4. Insert the screws and fully tighten with a suitable screwdriver.
5. Repeat the two previous steps for the other side of the unit.
6. Insert the unit into the rack and secure with suitable screws.
7. Reconnect all the cables.

Case 5: Central Site/Remote site application is used in carrier or ISP

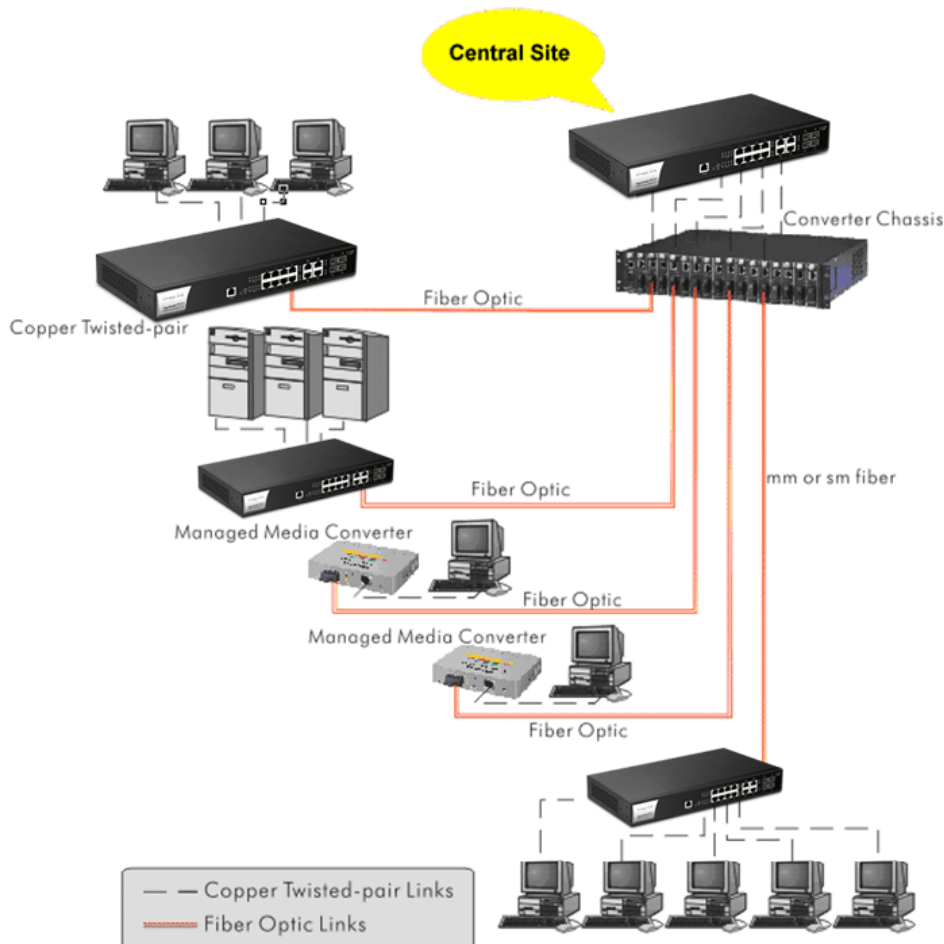

Case 6: Peer-to-peer application is used in two remote offices

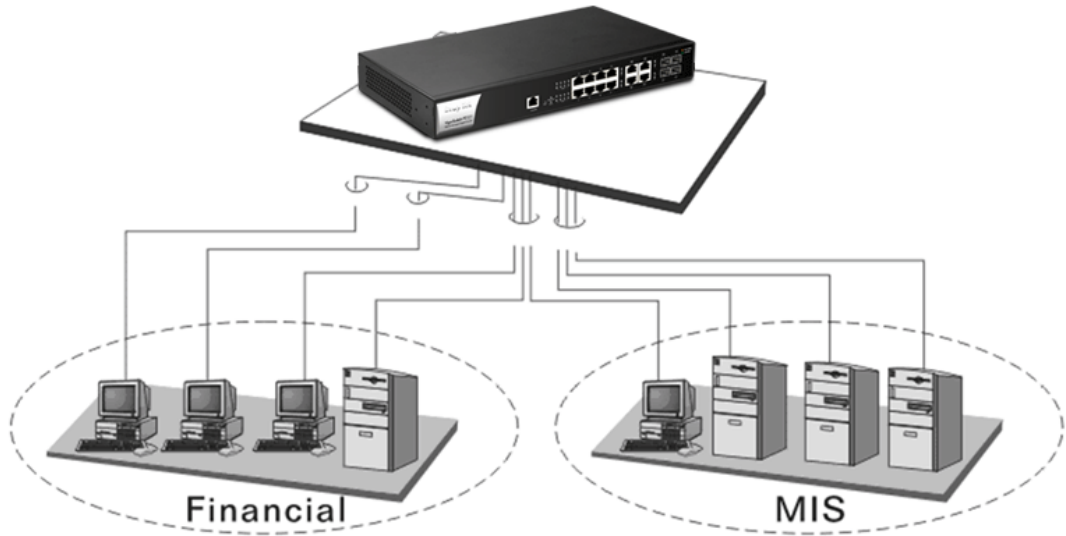

Case 7: Office network

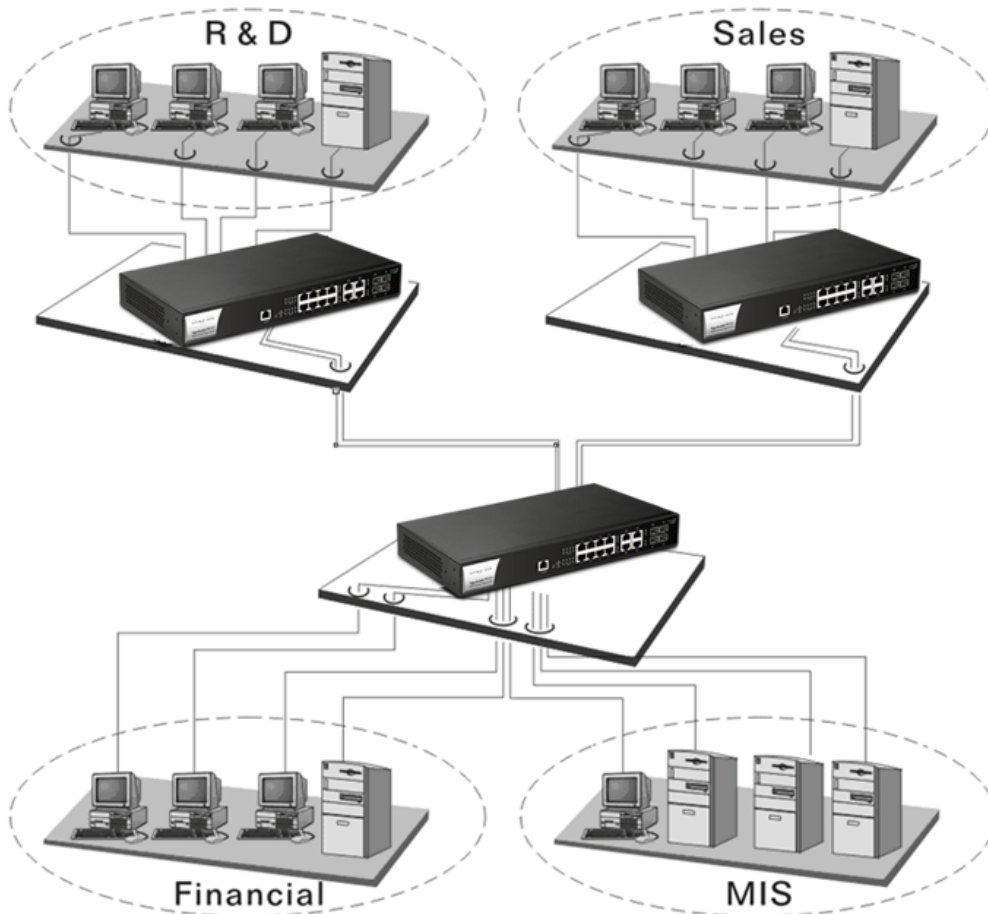

I-2-5 Installing Network Cables

Crossover or straight-through cable: All the ports on the switch support Auto-MDI/MDI-X functionality. Both straight-through or crossover cables can be used as the media to connect the switch with PCs as well as other devices like switches, hubs or router.

Category 3, 4, 5 or 5e, 6 UTP/STP cable: To make a valid connection and obtain the optimal performance, an appropriate cable that corresponds to different transmitting/receiving speed is required. To choose a suitable cable, please refer to the following table.

Media	Speed	Wiring
10/100/1000 Mbps copper	10 Mbps	Category 3,4,5 UTP/STP
	100Mbps	Category 5 UTP/STP
	1000 Mbps	Category 5e, 6 UTP/STP

I-2-6 Configuring the Management Agent of Switch

Users can monitor and configure the switch through the following procedures.

Configuring the Management Agent of VigorSwitch P2121 through the Ethernet Port.

There are several ways to configure and monitor the switch through Ethernet port, includes Web-UI and SNMP.

VigorSwitch, for example:

IP Address: 192.168.1.224

Subnet Mask: 255.255.255.0

Default Gateway: 192.168.1.254

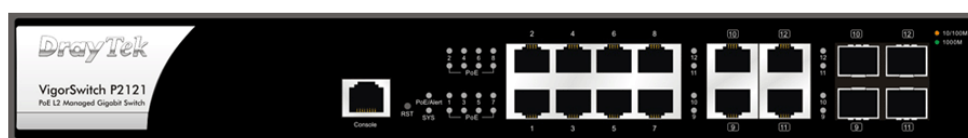

Assign a reasonable IP Address, for example:

IP Address: 192.168.1.100

Subnet Mask: 255.255.255.0

Default Gateway: 192.168.1.254



Ethernet LAN

I-2-7 Managing VigorSwitch P2121 through Ethernet Port

Before start using the switch, the IP address setting of the switch should be done, then perform the following steps:

1. Set up a physical path between the configured the switch and a PC by a qualified UTP Cat. 5e cable with RJ-45 connector.

Note: If PC directly connects to the switch, you have to setup the same subnet mask between them. But, subnet mask may be different for the PC in the remote site. Please refer to the above figure about the Web Smart Switch default IP address information.

2. After configuring correct IP address on your PC, open your web browser and access switch's IP address.

Default system account is "admin", with password "admin" in default. Switch IP address is "192.168.1.224" by default with DHCP client enabled.

I-2-8 IP Address Assignment

For IP address configuration, there are three parameters needed to be filled in. They are IP address, Subnet Mask, Default Gateway and DNS.

IP address:

The address of the network device in the network is used for internetworking communication. Its address structure looks is shown below. It is "classful" because it is split into predefined address classes or categories.

Each class has its own network range between the network identifier and host identifier in the 32 bits address. Each IP address comprises two parts: network identifier (address) and host identifier (address). The former indicates the network where the addressed host resides, and the latter indicates the individual host in the network which the address of host refers to. And the host identifier must be unique in the same LAN. Here the term of IP address we used is version 4, known as IPv4.

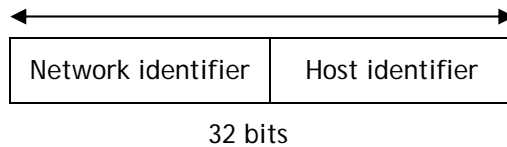

With the classful addressing, it divides IP address into three classes, class A, class B and class C. The rest of IP addresses are for multicast and broadcast. The bit length of the network prefix is the same as that of the subnet mask and is denoted as IP address/X, for example, 192.168.1.0/24. Each class has its address range described below.

Class A:

Address is less than 126.255.255.255. There are a total of 126 networks can be defined because the address 0.0.0.0 is reserved for default route and 127.0.0.0/8 is reserved for loopback function.

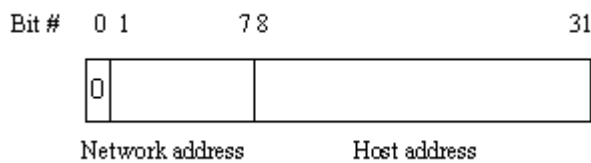

Class B:

IP address range between 128.0.0.0 and 191.255.255.255. Each class B network has a 16-bit network prefix followed 16-bit host address. There are 16,384 (2^{14})/16 networks able to be defined with a maximum of 65534 ($2^{16} - 2$) hosts per network.

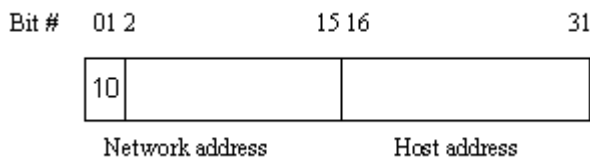

Class C:

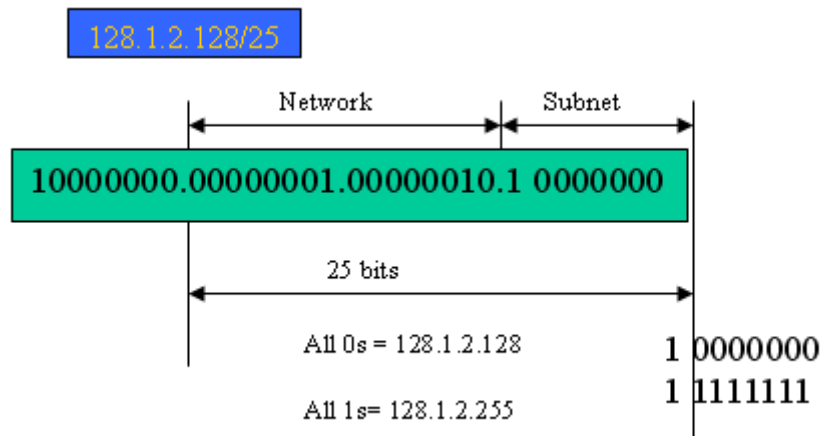

In this diagram, you can see the subnet mask with 25-bit long, 255.255.255.128, contains 126 members in the sub-netted network. Another is that the length of network prefix equals the number of the bit with 1s in that subnet mask. With this, you can easily count the number of IP addresses matched. The following table shows the result.

Prefix Length	No. of IP matched	No. of Addressable IP
/32	1	-
/31	2	-
/30	4	2
/29	8	6
/28	16	14
/27	32	30
/26	64	62
/25	128	126
/24	256	254
/23	512	510
/22	1024	1022
/21	2048	2046
/20	4096	4094
/19	8192	8190
/18	16384	16382
/17	32768	32766
/16	65536	65534

According to the scheme above, a subnet mask 255.255.255.0 will partition a network with the class C. It means there will have a maximum of 254 effective nodes existed in this sub-netted network and is considered a physical network in an autonomous network. So it owns a network IP address which may looks like 168.1.2.0.

With the subnet mask, a bigger network can be cut into small pieces of network. If we want to have more than two independent networks in a worknet, a partition to the network must be performed. In this case, subnet mask must be applied.

For different network applications, the subnet mask may look like 255.255.255.240. This means it is a small network accommodating a maximum of 15 nodes in the network.

For assigning an IP address to the switch, you just have to check what the IP address of the network will be connected with the switch. Use the same network address and append your host address to it.

- ❖ First, IP Address: as shown above, enter "192.168.1.224", for instance. For sure, an IP address such as 192.168.1.x must be set on your PC.
- ❖ Second, Subnet Mask: as shown above, enter "255.255.255.0". Choose a subnet mask suitable for your network.

Note: The DHCP Setting is enabled in default. Therefore, if a DHCP server presented on network connected to the switch, check before accessing your switch is essential.

I-3 Accessing Web Page of VigorSwitch

1. Open any browser (e.g., Firefox) and type "192.168.1.224" as URL.
2. Please type "admin/admin" as the Username/Password and click Login.

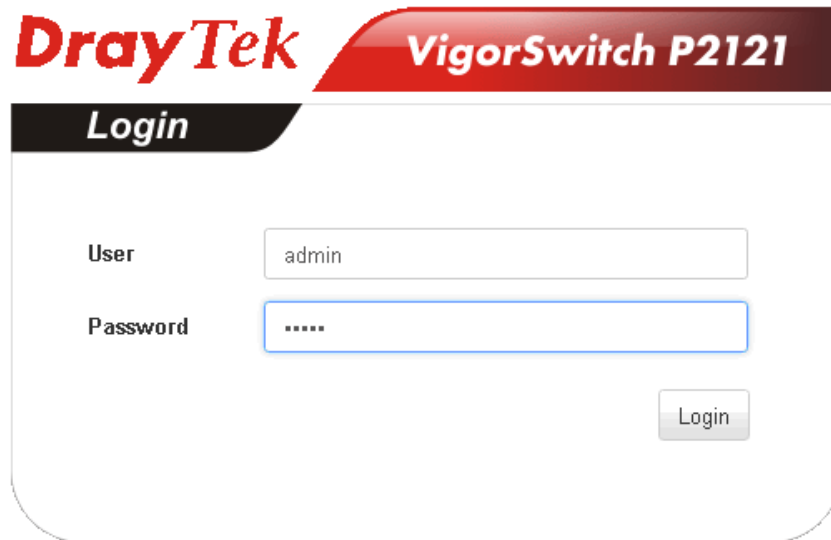

DrayTek **VigorSwitch P2121**

Login

User: admin

Password:

Login

3. Now, the Main Screen will appear.

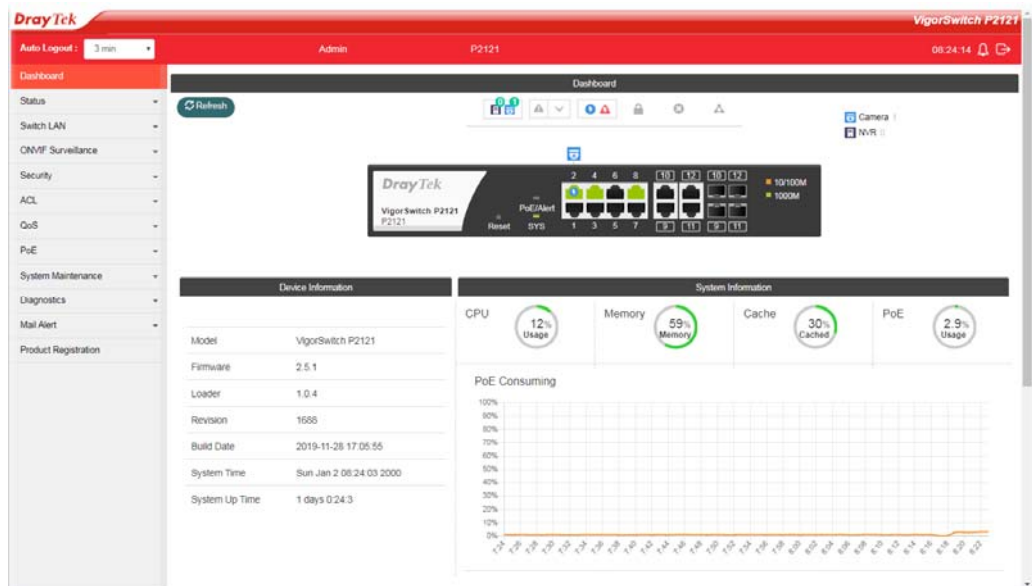

Info

The DHCP Setting is enabled in default. Therefore, if a DHCP server presented on network connected to VigorSwitch, checking before accessing VigorSwitch is essential.

I-4 Dashboard

Click Dashboard from the main menu on the left side of the main page.

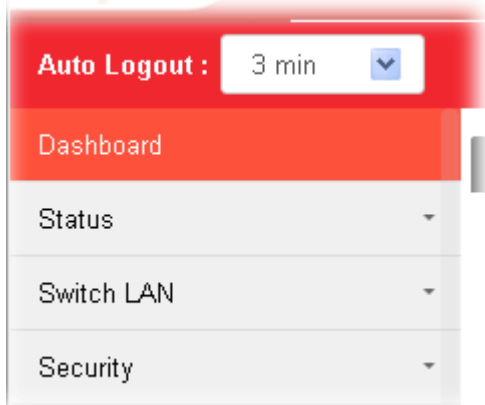

A web page with default selections will be displayed on the screen. Refer to the following figure:

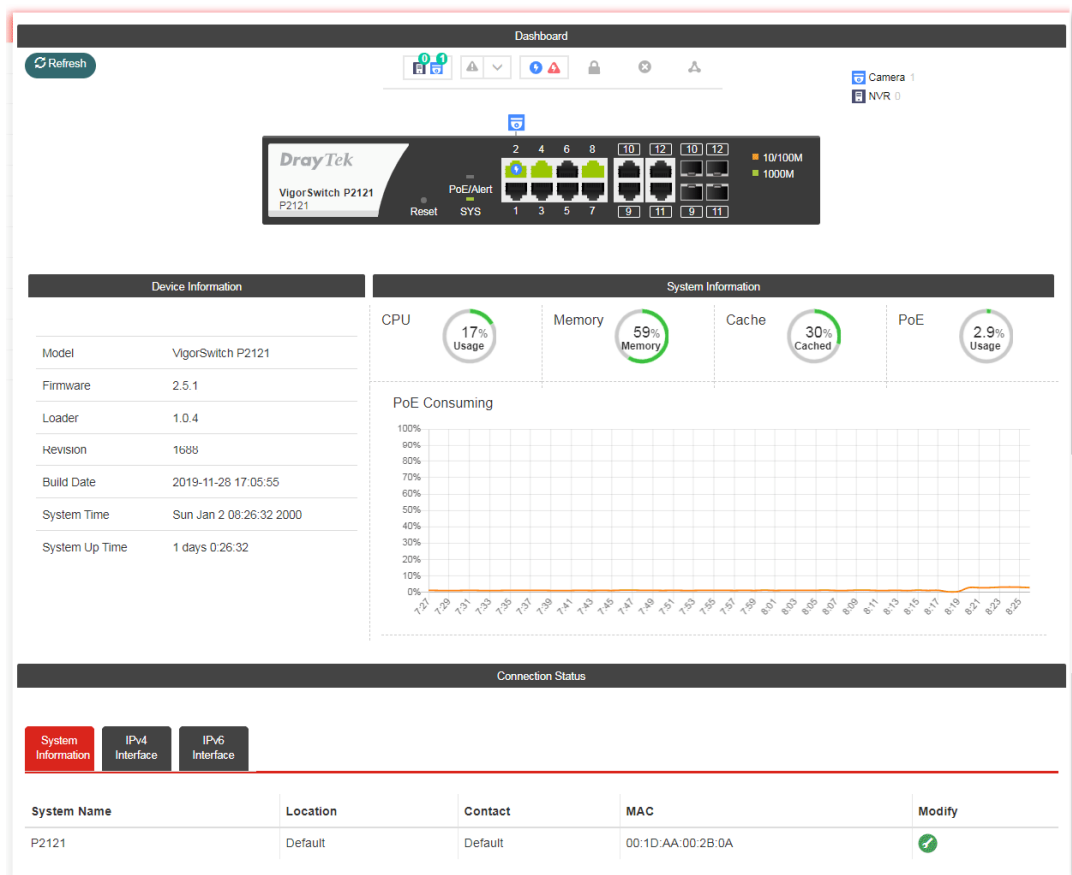

I-5 Status

I-5-1 Port Bandwidth Utilization

This page offers the traffic statistics including data information and data of interframe gap for each port (GE1 to GE12). In which, data of interframe gap can be displayed or hidden by choose Enable / Disable for IFG.

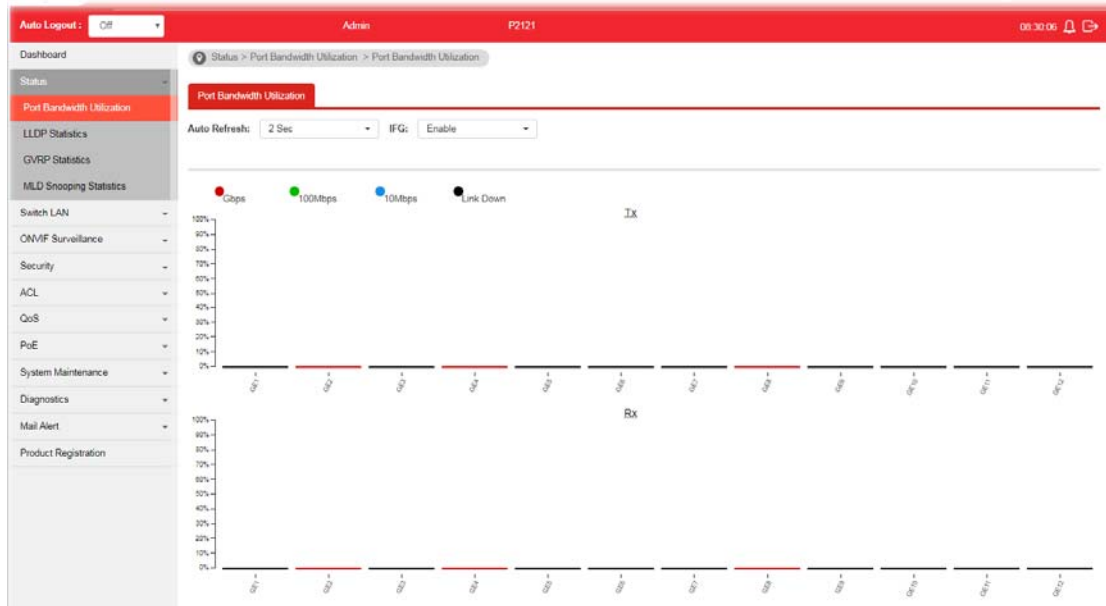

I-5-2 LLDP Statistics

This page offers the statistics of LLDP packets (in, out and error) of each port (GE1 to GE12).

LLDP Global Statistics							
Insertions	5						
Deletions	3						
Drops	0						
Age Outs	0						

LLDP Port Statistics							
Port	Tx Frames Total	Rx Frames Total	Rx Frames Discarded	Rx Frames Errors	Rx TLVs Discarded	Rx TLVs Unrecognized	Rx Ageouts Total
GE1	0	0	0	0	0	0	0
GE2	2205	0	0	0	0	0	0
GE3	0	0	0	0	0	0	0
GE4	2937	2937	0	0	0	0	0
GE5	0	0	0	0	0	0	0
GE6	0	0	0	0	0	0	0
GE7	0	0	0	0	0	0	0

I-5-3 GVRP Statistics

GVRP (Generic Attribute Registration Protocol) is used automatically for exchanging information for VLAN membership between switches. This page counts the GVRP information received on each port.

The screenshot shows the GVRP Statistics page with the following configuration and data:

- Auto Logout: Off
- Admin: P2121
- 08:33:06
- Navigation: Status > GVRP Statistics > Statistics
- Port: GE1
- Statistics: Transmit, Receive, Error
- Refresh Rate: 10 sec

Tx Statistics							
Port	Join empty	Empty	Leave Empty	Join In	Leave In	Leave All	
GE1	0	0	0	0	0	0	

Rx Statistics							
Port	Join empty	Empty	Leave Empty	Join In	Leave In	Leave All	
GE1	0	0	0	0	0	0	

Error Statistics					
Port	Invalid Protocol ID	Invalid Attribute Type	Invalid Attribute Value	Invalid Attribute Length	Invalid Event
GE1	0	0	0	0	0

I-5-4 MLD Snooping Statistics

This page counts the MLD messages received or transmitted on the network.

The screenshot shows the MLD Snooping Statistics page with the following configuration and data:

- Auto Logout: Off
- Admin: P2121
- 08:34:44
- Navigation: Status > MLD Snooping Statistics > Statistics
- Buttons: Refresh, Clear All

Rx Statistics	
Rx Total	0
Rx Valid	0
Rx Invalid	0
Rx Other	0
Rx Leave	0
Rx Report	0
Rx General Query	0
Rx Special Group Query	0
Rx Source-specific Group Query	0

Tx Statistics	
Tx Leave	0
Tx Report	0
Tx General Query	0
Tx Special Group Query	0
Tx Source-specific Group Query	0

Part II Switch LAN

II-1 General Setup

General setup is used to configure settings for the switch network interface and offers how the switch connects to a remote server to get services.

II-1-1 Management IP/VLAN

The switch needs an IP address for it to be managed over the network. The factory default IP address is 192.168.1.224. The subnet mask specifies the network number portion of an IP address. The factory default subnet mask is 255.255.255.0.

Use the IPv6 Address (IPv4/IPv6) screen to configure the switch IPv6 address and the default gateway device. The gateway field specifies the IPv6 address of the gateway (next hop) for outgoing traffic. In addition, this page allows the network administrator to change the VLAN ID of management access. Management access protocols such as http, https, SNMP and etc., are only accessible from the VLAN specified as management VLAN.



Info

If VigorSwitch has connected to Vigor router, it will use the IP address obtained from the DHCP server on Vigor router. Thus, the user must type the assigned IP as URL for accessing into the web user interface of VigorSwitch. If not, 192.168.1.224 shall be the default IP.

Available settings are explained as follows:

Item	Description
IPv4	
Mode	Select the mode of network connection. Static - Use static IPv4 address. DHCP - Use DHCP provisioned IP address and Gateway if feasible.
IP Address	It is available when Static is selected as Mode . Enter the IP address of your switch in dotted decimal notation

	for example 192.168.1.224. If static mode is enabled, enter IP address in this field.
Subnet Mask	It is available when Static is selected as Mode . Enter the IP subnet mask of your switch in dotted decimal notation for example 255.255.255.0. If static mode is enabled, enter subnet mask in this field.
Gateway	It is available when Static is selected as Mode . Enter the IP address of the gateway in dotted decimal notation. If static mode is enabled, enter gateway address in this field.
DNS Server 1	It is available when Static is selected as Mode . If static mode is enabled, enter primary DNS server address in this field.
DNS Server 2	It is available when Static is selected as Mode . If static mode is enabled, enter secondary DNS server address in this field.
IPv6	
Auto Configuration	Enable - Check it to let switch automatically configure IPv6 address.
IPv6 Address	It is available when Auto Configuration is set as Disable . Enter the IPv6 address of your switch. If auto configuration mode is disabled, enter IPv6 address in this field.
Link Local Address	Display link local address.
Gateway	It is available when Auto Configuration is set as Disable . Enter the IPv6 address of the router as your default IPv6 gateway to access IPv6 Internet or other IPv6 network.
DNS Server 1	It is available when Auto Configuration is set as Disable . If static mode is enabled, enter primary DNS server address in this field.
DNS Server 2	It is available when Auto Configuration is set as Disable . If static mode is enabled, enter secondary DNS server address in this field.
DHCPv6 Client	It is available when Auto Configuration is set as Enable . Enable this feature if there is a DHCPv6 server on your network for assigning IPv6 Address, instead of using Router Advertisement.
Management VLAN	
Management VLAN	Select the VLAN ID as management VLAN. You can create additional VLAN profiles by Switch LAN>>VLAN management>> Create VLAN .
Apply	Apply the settings to the switch.

II-2 Port Setting

II-2-1 General Setting

Port Setting is used to configure settings for the switch ports, trunk, Layer 2 protocols and other switch features.

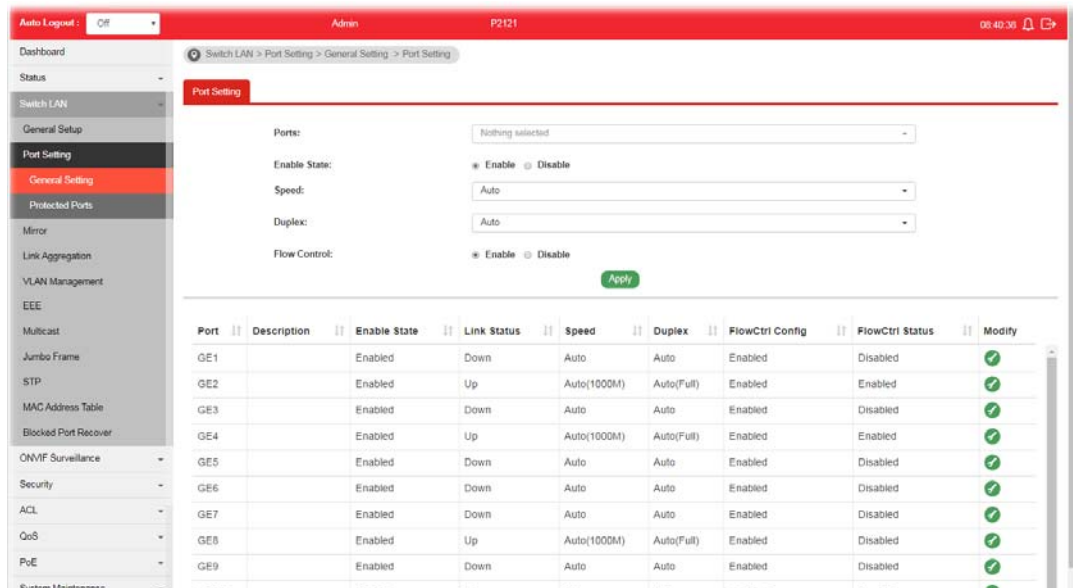

Available settings are explained as follows:

Item	Description
Ports	Use the drop down list to select one or more LAN port(s).
Enable State	Enable -Click it to enable the port. Disable - Click it to disable the port.
Speed	<p>Port speed capabilities:</p> <ul style="list-style-type: none"> ● Auto: Auto speed with all capabilities. ● Auto-10M: Auto speed with 10M ability only. ● Auto-100M: Auto speed with 100M ability only. ● Auto-1000M: Auto speed with 1000M ability only. ● Auto-10/100M: Auto speed with 10/100M ability. ● 10M: Force speed with 10M ability. ● 100M: Force speed with 100M ability. ● 1000M: Force speed with 1000M ability. <p>Selecting Auto (auto-negotiation) allows one port to negotiate with a peer port automatically to obtain the connection speed and duplex mode that both ends support. When auto-negotiation is turned on, a port on the switch negotiates with the peer automatically to determine the connection speed and duplex mode. If the peer port does not support auto-negotiation or turns off this feature, the switch determines the connection speed by detecting the signal on the cable and using half duplex mode. When the switch's auto-negotiation is turned off, a port uses the pre-configured speed and duplex mode when making a connection, thus</p>

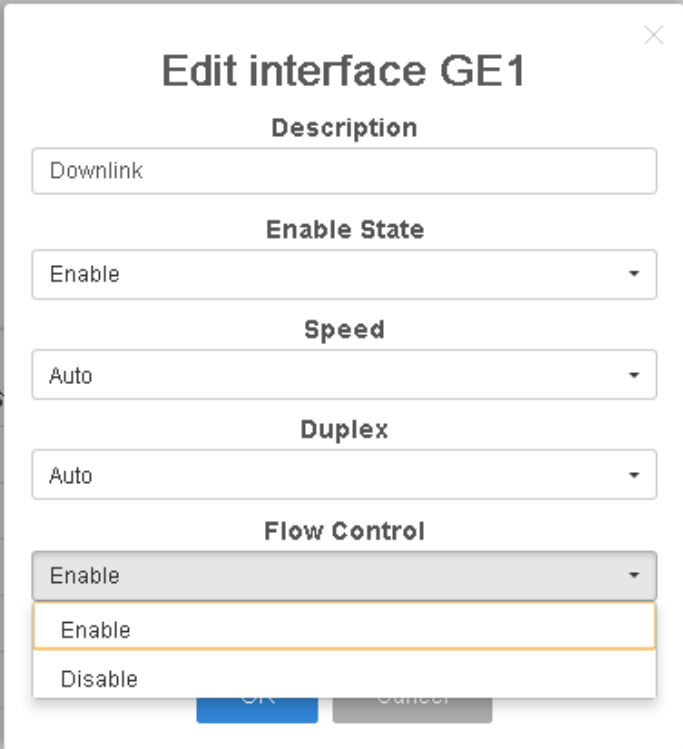
	<p>requiring you to make sure that the settings of the peer port are the same in order to connect.</p> <p>For SFP fiber module, you might need to manually configure the speed to match fiber module speed.</p>
Duplex	<p>Port duplex capabilities:</p> <ul style="list-style-type: none"> ● Auto: Auto duplex with all capabilities. ● Half: Auto speed with 10/100M ability only. ● Full: Auto speed with 10/100/1000M ability only.
Flow Control	<p>A concentration of traffic on a port decreases port bandwidth and overflows buffer memory causing packet discards and frame losses. Flow Control is used to regulate transmission of signals to match the bandwidth of the receiving port. The switch uses IEEE802.3x flow control in full duplex mode and backpressure flow control in half duplex mode. IEEE802.3x flow control is used in full duplex mode to send a pause signal to the sending port, causing it to temporarily stop sending signals when the receiving port memory buffers fill. Back Pressure flow control is typically used in half duplex mode to send a "collision" signal to the sending port (mimicking a state of packet collision) causing the sending port to temporarily stop sending signals and resend later.</p> <p>Enable - Click it to enable such function.</p> <p>Disable - Click it to disable such function.</p>
Apply	Apply the settings to the switch.
Modify	<p>It is used to manually enter the description, state, speed, duplex, flow control for the port.</p> 

II-2-2 Protected Ports

This page allows the network administrator to configure protected port setting to prevent the selected ports from communication with each other. Protected port is only allowed to communicate with unprotected port.

For example, GE1 and GE3 are selected in Port List and Enable is clicked as Protected, then users behind GE1 and GE3 are separated and can not communicate with each other.

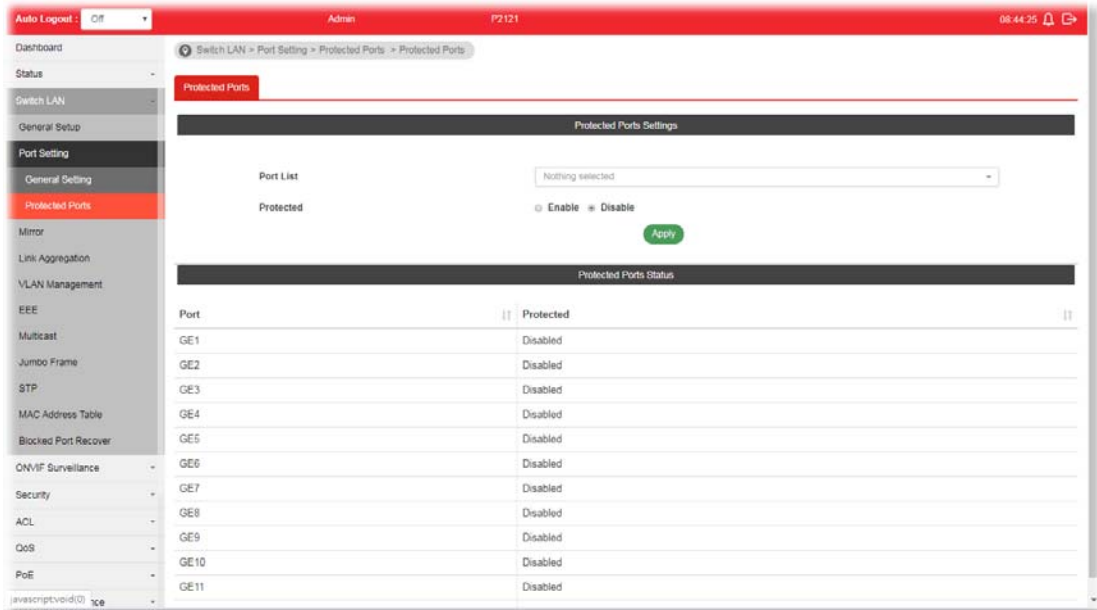

Available settings are explained as follows:

Item	Description
Protected Ports Settings	<ul style="list-style-type: none"> ● Port List - Use the drop down list to select the port(s) (GE1 to GE12) for applying the settings configured in this page. ● Protected - Click Enable to activate the protected port function. ● Apply - The modification made above can be applied on to the selected GE port immediately.
Protected Port Status	Display current status for each GE port.

II-3 Mirror

This section provides ability to mirror packets coming in or going out on any port to a destination port. Through the packet duplication in the destination port, this feature is convenient for system administrator to monitor / understand the traffic operation.

Session ID 1 to 4 can be enabled simultaneously and operate independently.

Session ID	Destination Port	Allow Ingress	Sniff Ports(RX)	Sniff Ports(TX)
1	N/A	N/A	N/A	N/A
2	N/A	N/A	N/A	N/A
3	N/A	N/A	N/A	N/A
4	N/A	N/A	N/A	N/A

Available settings are explained as follows:

Item	Description
Session ID	Select the session ID (profile 1 to 4) of mirror operation you wish to configure.
Monitor Session State	Enable - Enable specified mirror session. Disable - Disable specified mirror session.
Destination Port	Specify the port where you wish to observe the mirrored packets.
Allow Operation as Normal Port	Enable - The destination port is able to function as a port connecting to network, communicating with other network devices. Disable - Only observe the mirrored packets.
Sniff Ports (RX) / (TX)	Select the port(s) which you wish to mirror the traffic, Rx for mirror the packets into the port, Tx for mirror the packets going out from the port.
Apply	Apply the settings to the switch.

II-4 Link Aggregation

LAG means Link Aggregation Group which groups some physical ports together to make a single high-bandwidth data path. Thus it can implement traffic load sharing among the member ports in a group to enhance the connection reliability.

II-4-1 LAG Setting

This page allows to configure Load Balance Algorithm for Link Aggregation.

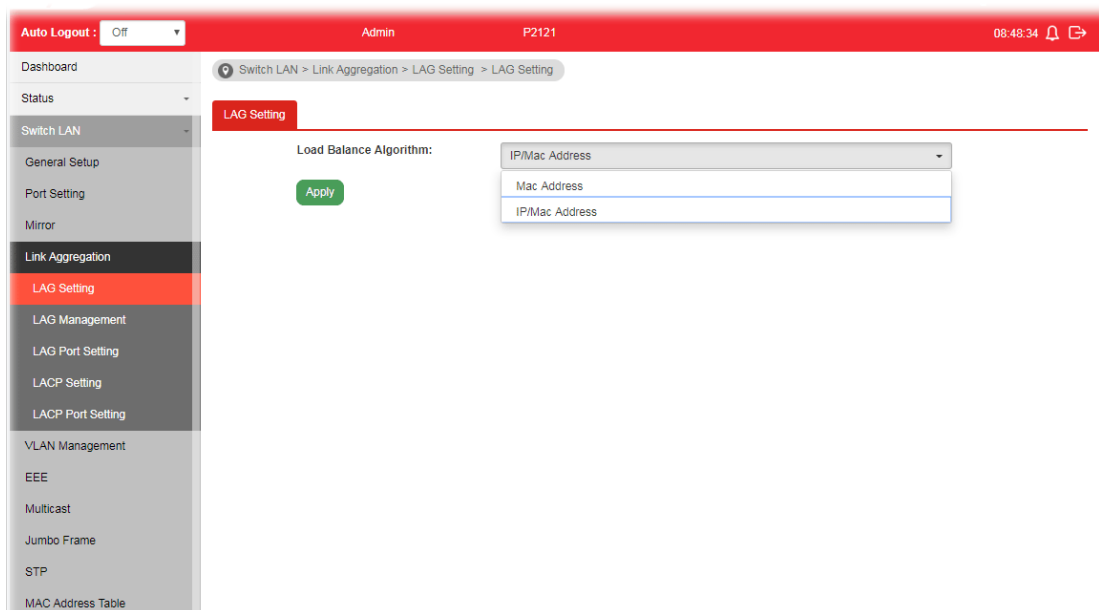

Available settings are explained as follows:

Item	Description
Load Balance Algorithm	Select your Load balance algorithm. MAC address - Aggregated group will balance the traffic based on different MAC addresses. Therefore, the packets from different MAC addresses will be sent to different links. IP/Mac Address - Aggregated group will balance the traffic based on MAC addresses and IP addresses. Therefore, the packets from same MAC addresses but different IP addresses will be sent to different links.
Apply	Apply the settings to the switch.

II-4-2 LAG Management

There are eight LAG profiles allowed to group different physical ports (GE1 to GE12). The system will assign certain port(s) as Active Member and Standby Member according to the GE selections.

LAG	Description	Port Type	Link Status	Active Member	Standby Member	Modify
LAG1		---	Not Present			✓
LAG2		---	Not Present			✓
LAG3		---	Not Present			✓
LAG4		---	Not Present			✓
LAG5		---	Not Present			✓
LAG6		---	Not Present			✓
LAG7		---	Not Present			✓
LAG8		---	Not Present			✓

Available settings are explained as follows:

Item	Description
Description	Display the port description.
Port Type	Display the type of the LAG.
Link Status	Display LAG port link status.
Active Member	Display active member ports of the LAG.
Standby Member	Display inactive or candidate member ports of the LAG.

Modify It is used to edit the name, type and port number for each link aggregation profile.

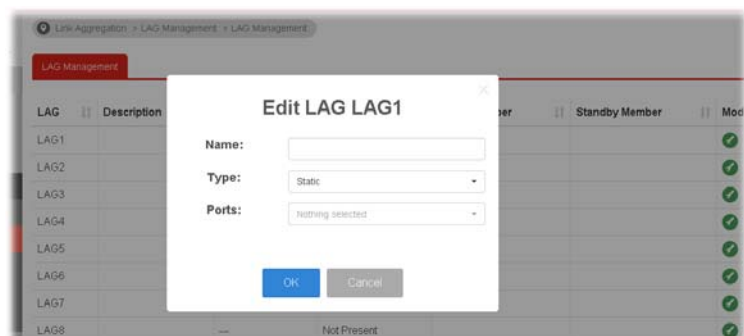

Name- Enter a string as LAG name.

Type - Use the drop down menu to specify the type for LAG.

- **Static-** The static aggregated port sends packets over active member without detecting or negotiating with remote aggregated port.
- **LACP-** The LACP aggregated ports place member into

active only after negotiated with remote aggregated port for best reliability.

- Ports - Select the physical ports for this LAG profile.

II-4-3 LAG Port Setting

This page defines port setting for each LAG profile (LAG1 to LAG8), including data speed and enabling/disabling the flow control.

LAG	Description	Port Type	Enable State	Link Status	Speed	Duplex	Flow Control ...	Flow Control ...	Modif
LAG1		---	Enabled	Down	Auto(All)	Auto	Enabled	Disabled	✓
LAG2		---	Enabled	Down	Auto(All)	Auto	Enabled	Disabled	✓
LAG3		---	Enabled	Down	Auto(All)	Auto	Enabled	Disabled	✓
LAG4		---	Enabled	Down	Auto(All)	Auto	Enabled	Disabled	✓
LAG5		---	Enabled	Down	Auto(All)	Auto	Enabled	Disabled	✓
LAG6		---	Enabled	Down	Auto(All)	Auto	Enabled	Disabled	✓

Available settings are explained as follows:

Item	Description
LAG	Use the drop down list to select one or more LAG profiles.
Enable	<p>Enable -Click it to enable the profile.</p> <p>Disable - Click it to disable the profile.</p>
Speed	<p>Port speed capabilities:</p> <ul style="list-style-type: none"> ● Auto: Auto speed with all capabilities. ● Auto-10M: Auto speed with 10M ability only. ● Auto-100M: Auto speed with 100M ability only. ● Auto-1000M: Auto speed with 1000M ability only. ● Auto-10/100M: Auto speed with 10/100M ability. ● 10M: Force speed with 10M ability. ● 100M: Force speed with 100M ability. ● 1000M: Force speed with 1000M ability. <p>Selecting Auto (auto-negotiation) allows one port to negotiate with a peer port automatically to obtain the connection speed and duplex mode that both ends support. When auto-negotiation is turned on, a port on the switch negotiates with the peer automatically to determine the connection speed and duplex mode. If the peer port does not support auto-negotiation or turns off this feature, the switch determines the connection speed by detecting the signal on the cable and using half duplex mode. When the switch's auto-negotiation is turned off, a port uses the pre-configured</p>

	<p>speed and duplex mode when making a connection, thus requiring you to make sure that the settings of the peer port are the same in order to connect.</p> <p>For SFP fiber module, you might need to manually configure the speed to match fiber module speed.</p>
Flow Control	<p>A concentration of traffic on a port decreases port bandwidth and overflows buffer memory causing packet discards and frame losses. Flow Control is used to regulate transmission of signals to match the bandwidth of the receiving port. The switch uses IEEE802.3x flow control in full duplex mode and backpressure flow control in half duplex mode. IEEE802.3x flow control is used in full duplex mode to send a pause signal to the sending port, causing it to temporarily stop sending signals when the receiving port memory buffers fill. Back Pressure flow control is typically used in half duplex mode to send a "collision" signal to the sending port (mimicking a state of packet collision) causing the sending port to temporarily stop sending signals and resend later.</p> <p>Enable - Click it to enable such function. Disable - Click it to disable such function.</p>
Apply	Apply the settings to the switch.
Modify	It is used to edit status, speed, and flow control for the LAG.

II-4-4 LACP Setting

This page allows the network administrator to enable or disable the LACP function.

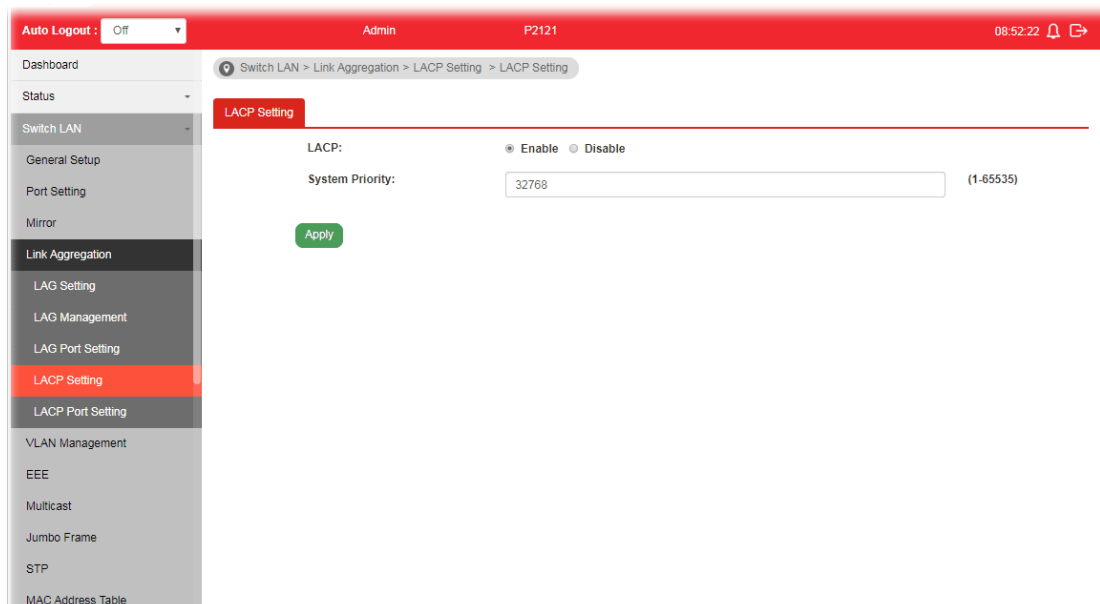

Available settings are explained as follows:

Item	Description
LACP	<p>Enable - Click it to enable such function. Disable - Click it to disable the function.</p>
System Priority	The priority is used to determine which switch (local or remote) on the LAG connection is able to decide LACP activities. The lower the number is, the higher the priority for

	Vigorwitch will be. Therefore, the switch with the highest system priority (e.g., 1) can make decisions about which ports actively participate in LAG at a given time.
Apply	Apply the settings to the switch.

II-4-5 LACP Port Setting

This section provides few detailed configuration regarding to Ports under LACP protocol.

Available settings are explained as follows:

Item	Description
Ports	Use the drop down list to specify LAN Port.
Priority	Enter a port priority number for the port.
Timeout	<p>The timeout option decides how local switch of LAG connection determines connection to be lost. Switch would also notify the remote switch about this setting value, so that remote switch can send LACP PDU in correct timing.</p> <p>Long - LACP PDU will be sent every 30 seconds. If port member is not seen over 90 seconds, it will cause port member timeout.</p> <p>Short - LACP PDU will be sent per second. If port member is not seen over 3 seconds, it will cause port member timeout.</p>
Apply	Apply the settings to the switch.
Modify	<p>It is used to edit settings (priority and timeout) for LACP port.</p>

II-5 VLAN Management

A virtual local area network, virtual LAN or VLAN, is a group of hosts with a common set of requirements that communicate as if they were attached to the same broadcast domain, regardless of their physical location. A VLAN has the same attributes as a physical local area network (LAN), but it allows for end stations to be grouped together even if they are not located on the same network switch. VLAN membership can be configured through software instead of physically relocating devices or connections.

II-5-1 Create VLAN

This page allows a user to add, edit or delete VLAN settings.

Available settings are explained as follows:

Item	Description																
Action	Select which action to perform, add VLANs or delete VLANs. Add - Create a new VLAN profile. Delete - Delete an existed VLAN profile.																
VLAN ID	Enter the number as VLAN ID to be created or deleted. If you want to create / delete multiple VLAN profiles, simply enter multiple VLAN ID separated by comma, and/or range of VLAN ID using hyphen.																
VLAN Name	Enter the prefix you wish to add followed by VLAN ID as VLAN name. Leave it empty for using default "VLAN". After clicking Apply, you will see: <table border="1"> <thead> <tr> <th>VLAN ID</th> <th>VLAN Name</th> <th>VLAN Type</th> <th>Modify</th> </tr> </thead> <tbody> <tr> <td>1</td> <td>default</td> <td>Default</td> <td></td> </tr> <tr> <td>2</td> <td>marketing0002</td> <td>Static</td> <td> </td> </tr> <tr> <td>3</td> <td>marketing0003</td> <td>Static</td> <td> </td> </tr> </tbody> </table>	VLAN ID	VLAN Name	VLAN Type	Modify	1	default	Default		2	marketing0002	Static		3	marketing0003	Static	
VLAN ID	VLAN Name	VLAN Type	Modify														
1	default	Default															
2	marketing0002	Static															
3	marketing0003	Static															
Apply	Apply the settings to the switch.																

Modify



- Modify the name of the selected VLAN ID.

The modal dialog is titled "Edit name of VLAN 4067". It contains a text input field with the text "__HDMI__VLAN4067". Below the input field are two buttons: "OK" (blue) and "Cancel" (grey). There is an "Apply" button in the top right corner of the dialog.

New Name - Type a name for such VLAN profile.

OK - Apply the settings to the switch.

Cancel - Close the page and return to previous page.



- Delete the selected VALN ID.

II-5-2 Interface Settings

This page allows a user to configure interface setting related to VLAN.

The screenshot shows the "Interface Settings" page in a web interface. The page has a red header with "Auto Logout : Off", "Admin", "P2121", and "09:02:04". The left sidebar contains a menu with "VLAN Management" selected, and "Interface Settings" highlighted. The main content area has a red "Interface Settings" tab. The settings include: "Port Select" (Nothing selected), "Interface VLAN Mode" (Hybrid selected), "PVID" (1), "Accepted Type" (All selected), "Ingress Filtering" (Enable selected), "Tagged VLAN" (Nothing selected), "Untagged VLAN" (Nothing selected), and "Forbidden VLAN" (Nothing selected). An "Apply" button is at the bottom. Below the settings is a table with columns: Port, Interface VLAN, PVID, Tagged VLAN, Untagged VLAN, Forbidden VLAN, Accept Fram..., Ingress Filter..., and Upl.

Port	Interface VLAN	PVID	Tagged VLAN	Untagged VLAN	Forbidden VLAN	Accept Fram...	Ingress Filter...	Upl
GE1	Trunk	1	---	1	---	ALL	Enabled	Dis
GE2	Trunk	1	---	1	---	ALL	Enabled	Dis

Available settings are explained as follows:

Item	Description
Port Select	Select LAN ports to configure VLAN Settings.
Interface VLAN Mode	Select the VLAN mode of the interface. Hybrid - Support all functions as defined in IEEE 802.1Q specification. Access - Accept only untagged frames and join an untagged

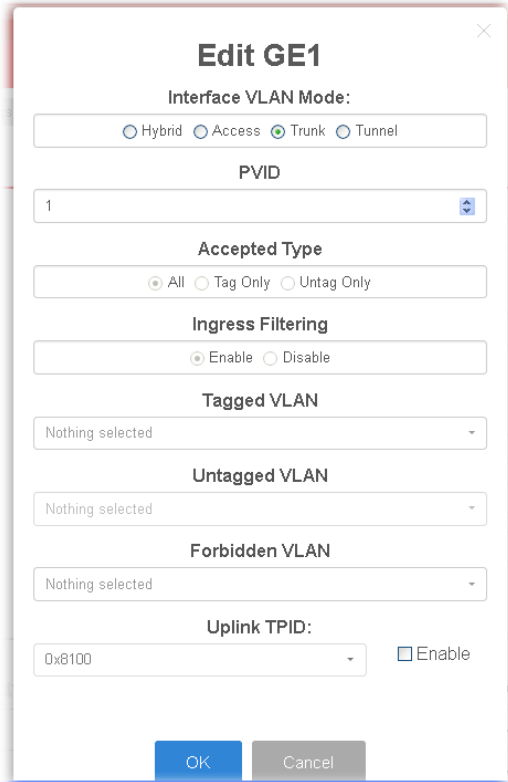
	<p>VLAN.</p> <p>Trunk - An untagged member of one VLAN at most, and is a tagged member of zero or more VLANs.</p>
PVID	<p>A PVID (Port VLAN ID) is a tag that adds to incoming untagged frames received on a port so that the frames are forwarded to the VLAN group that the tag defines.</p> <p>For port under Access Mode, VLAN ID provided as PVID would automatically be selected as the untagged VLAN.</p>
Accepted Type	<p>Specify the acceptable-frame-type of the specified interfaces. It's only available with Hybrid mode.</p> <p>All - Accept frames regardless it's tagged with 802.1q or not.</p> <p>Tag Only - Accept frames only with 802.1q tagged.</p> <p>Untag Only - Accept frames untagged.</p>
Ingress Filtering	<p>Enable the ingress filtering to filter out any packets not belong to any VLAN members of this port. It is enabled automatically while operating in Access and Trunk mode.</p> <p>Enabled - Click it to enable the function.</p> <p>Disabled - Click it to disable the function.</p>
Tagged VLAN	Specify the VLAN profile tagged in the VLAN.
Untagged VLAN	Specify the VLAN profile untagged in the VLAN.
Forbidden VLAN	Specify the VLAN profile forbidden in the VLAN.
Apply	Apply the settings to the switch.
Modify	<p> - It is used to edit settings for the selected port.</p> 

II-5-3 Voice VLAN

With such feature, a VLAN will be created temporarily and when the specified OUI device delivers protocol packets related to "VoIP", VigorSwitch will guide these packets into the specified Voice LAN with specified priority tag to speed up the packet transmission. Such voice VLAN is only active inside VigorSwitch for packet transmission. After these packets leave VigorSwitch, the Voice VLAN tag will be removed immediately.

II-5-3-1 Properties

This page allows a user to configure global and per interface setting of voice VLAN.

The screenshot shows the 'Voice VLAN Properties' configuration page in the VigorSwitch web interface. The page has a red header with 'Auto Logout: Off', 'Admin', 'P2121', and '09:08:33'. The navigation menu on the left includes 'Dashboard', 'Status', 'Switch LAN', 'General Setup', 'Port Setting', 'Mirror', 'Link Aggregation', 'VLAN Management', 'Create Vlan', 'Interface Settings', 'Voice VLAN', 'MAC VLAN', 'Protocol VLAN', 'Surveillance VLAN', 'GVRP', 'EEE', 'Multicast', and 'Jumbo Frame'. The 'Voice VLAN' tab is selected. The main content area has three tabs: 'Properties', 'Telephony OUI Setting', and 'Port Setting'. The 'Properties' tab is active, showing the following settings:

- Voice VLAN State:** Radio buttons for 'Enable' and 'Disable'.
- Voice VLAN Id:** A dropdown menu showing 'Nothing selected' and an 'Enable' checkbox.
- Remark CoS/802.1p:** Radio buttons for 'Enable' and 'Disable'.
- Remark Value:** A dropdown menu showing '6'.
- Aging Time:** A text input field showing '1440' and a range '(30-65536 min)'.

An 'Apply' button is located below the settings.

Available settings are explained as follows:

Item	Description
Voice VLAN State	Enabled - Click it to enable Voice VLAN. Disabled - Click it to disable Voice VLAN.
Voice VLAN Id	Check the box of Enable first and then select Voice VLAN ID profile.
Remark CoS/802.1p	Click Enabled / Disabled to enable or disable 1p remarking. If enabled, qualified packets will be remarked by this value.
Remark Value	Specify the number of packets to be remarked. Specify the CoS/802.1p number you wish ingress VoIP packets be tagged with, so that QoS can prioritize it correctly.
Aging Time	Select value of aging time (30~65536 min). Default is 1440 minutes. A voice VLAN entry will be age out after this time if without any packet pass through.
Apply	Apply the settings to the switch.

II-5-3-2 Telephony OUI Setting

This page allows a user to add, edit or delete OUI MAC addresses. Default has 8 pre-defined OUI MAC.

OUI Address	Description	Edit
00:E0:BB	3COM	
00:03:6B	Cisco	
00:E0:75	Veritel	
00:D0:1E	Pingtel	
00:01:E3	Siemens	
00:60:B9	NEC/Philips	
00:0F:E2	H3C	
00:09:6E	Avaya	

Available settings are explained as follows:

Item	Description
OUI Address	Type OUI address.
Description	Enter a description of the specified MAC address to the voice VLAN OUI table.
Add	Click it to create a new voice OUI based on the settings configured above.
Modify	- Modify OUI setting for voice VLAN.
	- Click it to remove the selected OUI entry.

II-5-3-3 Port Setting

This page allows a user to specify LAN port(s) as Voice LAN port.

Available settings are explained as follows:

Item	Description
Port	Use the drop down list to specify one or more LAN ports.
State	Enabled - Click it to enable the port settings for Voice LAN. Disabled - Click it to disable the port settings for Voice LAN.
Cos Mode	If Remark CoS/802.1p is enabled in Voice VLAN>>Properties, settings in this page shall be applied. Otherwise, this option will not take effect. All - Once this port is identified as Voice VLAN by frame with matched OUI, remark CoS/802.1p shall tag for all ingress frame regardless of remarked frame matched with pre-configured OUI or not. Src (Source) - Once this port is identified as Voice VLAN by frame with matched OUI, remark CoS/802.1p shall tag for only the matched ingress frame with pre-configured OUI.
Apply	Apply the settings to the switch.
Edit	Click the icon under Edit for one entry to modify port settings (State, Cos Mode) for voice VLAN.

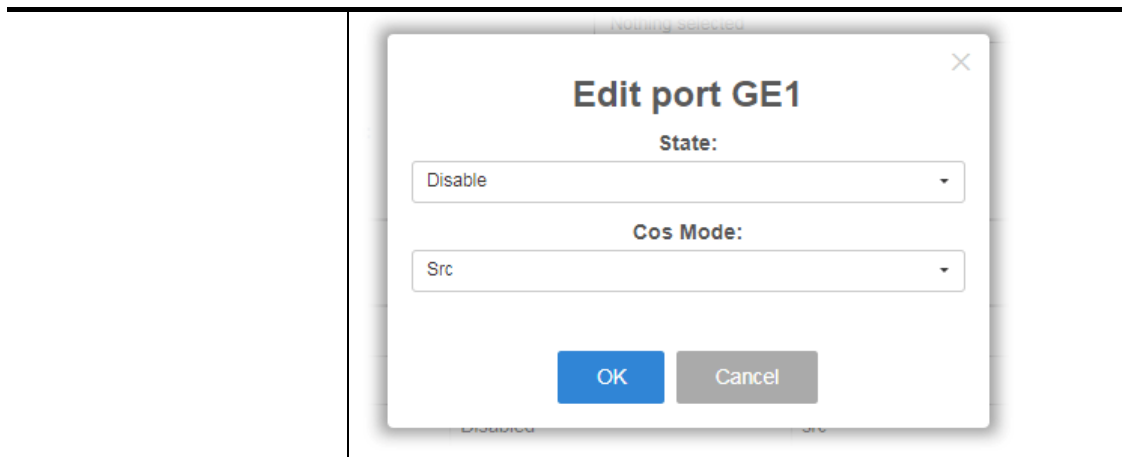

II-5-4 MAC VLAN

II-5-4-1 MAC Group

The MAC VLAN allows you to statically assign a VLAN ID to a host with specific MAC address(es). VigorSwitch allows you configure multiple groups with configured MAC address and mask to be active on ports and to be bound with VLAN ID. This page allows the network administrator to define groups with specific MAC addresses for later binding with VLAN and Port.

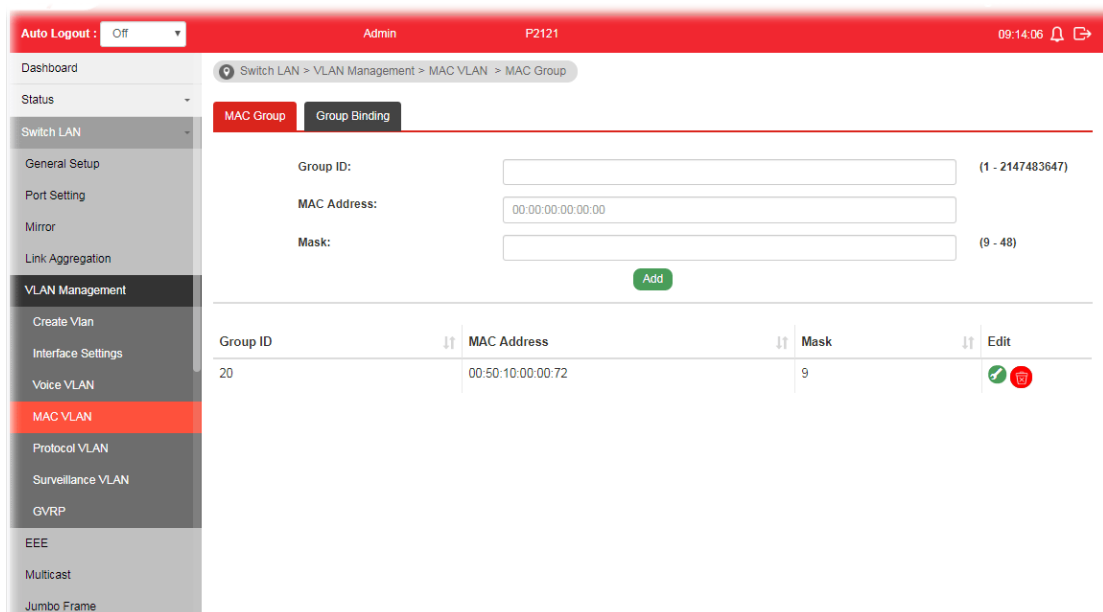

Available settings are explained as follows:

Item	Description
Group ID	It is a number for identification later, while chosen to be bound with VLAN/Port.
MAC Address	Enter the MAC address you wish to be classified in this group
Mask	The mask is the length of matching prefix you wish to have on MAC address. For example, configure mask in 10. It means a host with beginning of the 10-digit of MAC address will be checked, and classified into this group if matched.

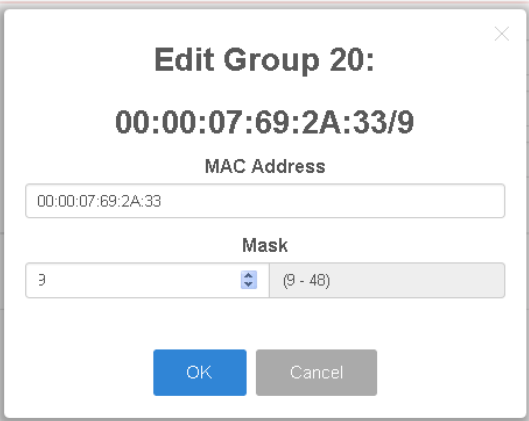
Add	Click it to create a new MAC group profile based on the settings configured above.
Edit	<p>Click the icon under Edit for one entry to modify settings for group ID.</p> 

I-5-4-3 Group Binding

The MAC VLAN allows you to statically assign a VLAN ID to a host with specific MAC address(es). VigorSwitch allows you to configure multiple groups with configured MAC address and mask to be active on ports and to be bound with VLAN ID. This page allows the network administrator to bind the group of specified MAC addresses with VLAN and Port.

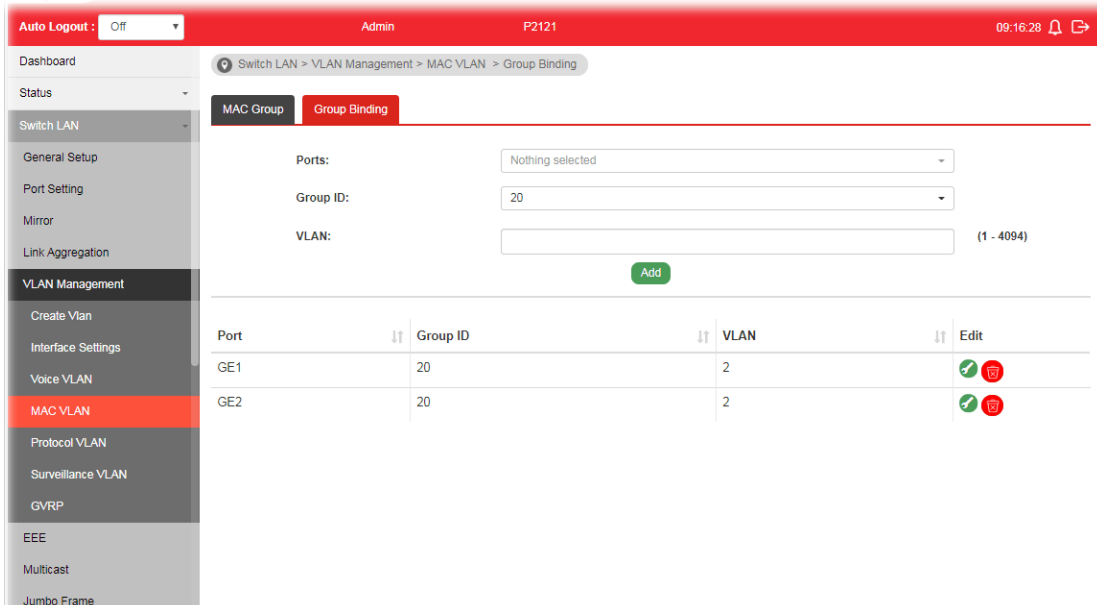

Available settings are explained as follows:

Item	Description
Ports	Select the ports you wish to be bound with specified MAC address group.
Group ID	Choose the group ID you have created in earlier section, which specified a group of host by MAC address and its mask.
VLAN	Enter the VLAN ID that you wish to be bound with.
Add	Click it to create a new MAC group binding profile based on the settings configured above.

Edit

Click the icon under **Edit** for one entry to modify settings for selected port profile.

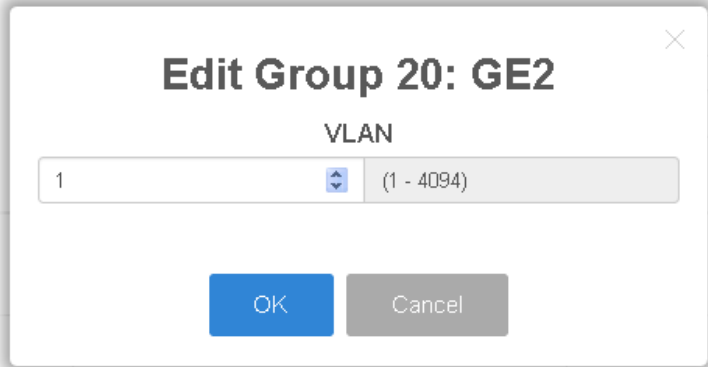

II-5-5 Protocol VLAN

VigorSwitch offers protocol VLANs which allows Network Administrator to filter out untagged traffic of certain protocol and then assign them a specific VLAN ID.

II-5-5-1 Protocol Group

Up to eight protocol groups can be defined, each of them can have a unique filtering criteria such as frame type and protocol value.

Available settings are explained as follows:

Item	Description
Group ID	It is a number for identification while bounding with VLAN/Port.
Frame Type	Use the drop-down list to specify the frame type which you would like to filter. <div style="border: 1px solid #ccc; padding: 5px; margin: 5px 0;"> <div style="border: 1px solid #ccc; padding: 2px;">Ethernet_II</div> <div style="border: 1px solid #ccc; padding: 2px; background-color: #fff;">Ethernet_II</div> <div style="border: 1px solid #ccc; padding: 2px;">IEEE802.3_LL_C_Other</div> <div style="border: 1px solid #ccc; padding: 2px;">RFC_1042</div> </div> <p>Ethernet_II - Packet will be mapped based on Ethernet version 2. IEEE802.3_LL_C_Other -Packet will be mapped based on 802.3 packet with LLC other header. RFC_1042 - Packet will be mapped based on RFC 1042.</p>
Protocol Value	Input a value (ranging from 0x600 -0xFFFF). Packets match with such value will be classified into this group.
Add	Click it to create a new protocol group profile based on the settings configured above.

Edit

- Modify setting for selected group.

Edit Group 1

Frame Type

IEEE802.3_LL_C_Other

Protocol Value

(0x600 - 0xFFFE) 0x 0601

OK
Cancel

- Click it to remove the group.

II-5-5-2 Group Binding

This page is for setting up the ports and protocol group that we would like to filter, and the VLAN ID we would like to assign.

Available settings are explained as follows:

Item	Description
Ports	Use the drop-down list to select one or more ports for applying protocol-based VLAN. Note that protocol-based VLAN can only be applied to the ports of which Interface VLAN Mode (at VLAN Management >> Interface Settings) is set to "Hybrid".
Group ID	Select the protocol group defined in Protocol Group setup.
VLAN	Use drop down list to choose a value as VLAN number.

Add

Add the above settings to the switch.
Before using **Add**, open **Switch LAN>>VLAN Management>>Interface Settings** to specify **Hybrid** as **Interface VLAN Mode** for the GE ports first. Otherwise, the following error message will appear.

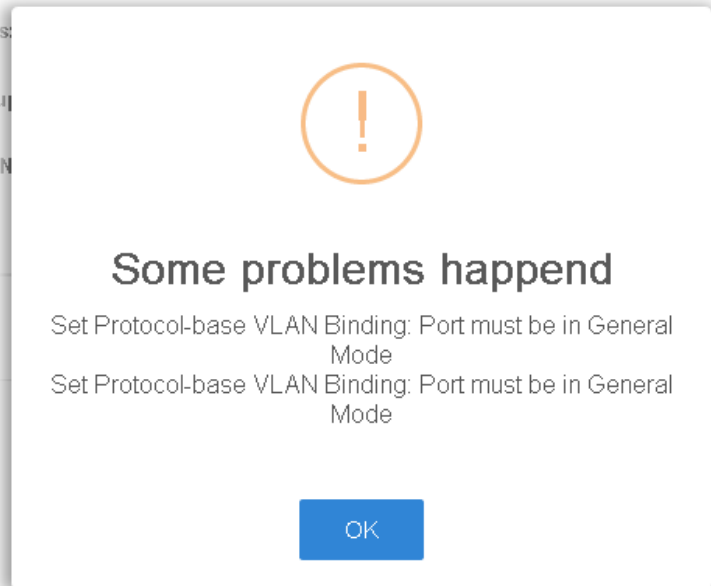

Edit



- Modify setting for the selected group.

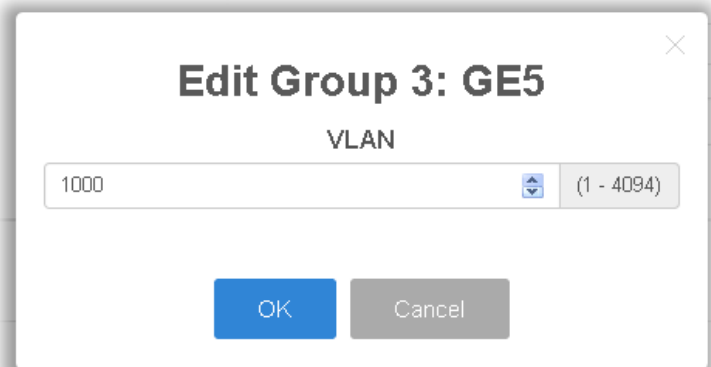

- Click it to remove the selected group.

II-5-6 Surveillance VLAN

Surveillance VLAN can be configured for VigorSwitch to identify the packets coming from an IP camera automatically and assign those traffics to a specific VLAN ID and CoS/802.1p value, this helps you to prioritize those traffics and improve video quality.

II-5-6-1 Property

This page is for setting up the VLAN to which the video traffic should be assigned and to enable/disable Surveillance VLAN on each port.

Available settings are explained as follows:

Item	Description
State	Enabled - Click it to enable the port settings for such VLAN. Disabled - Click it to disable the port settings for such VLAN.
VLAN ID	Choose a VLAN profile (created in Switch LAN>>VLAN Management>>Create Vlan) as Surveillance VLAN.
CoS/802.1p Remarking	Specify the CoS/802.1p number you wish ingress packets be tagged with, so that QoS can prioritize it correctly. Enable - If enabled, qualified packets will be remarked by this value.
Aging Time	Unit is second. Select value of aging time (30~65536 seconds). Default is 1440 seconds. VLAN entry will be aged out after this time if no packet passes through.
Apply	Apply the settings to the switch.
Edit	 - Click it to modify port setting status.

State -Set it to enable surveillance VLAN function of interface.

Mode -Select port surveillance VLAN mode.

- **Auto:** Surveillance VLAN auto detect packets that match OUI table and add received port into surveillance VLAN ID tagged member.
- **Manual:** User need add interface to VLAN ID tagged member manually.

QoS Policy - Select port QoS Policy mode.

- **Video Packet:** QoS attributes are applied to packets with OUI in the source MAC address.
- **All:** QoS attributes are applied to packets that are classified to the Surveillance VLAN.



OK - Apply the settings to the switch.

Cancel - Abandon the changes and return to previous page.

II-5-6-1 Surveillance OUI

Filtering Surveillance traffic is based on the OUI of the IP cameras. Users can add, edit, and delete OUI on this page.

Available settings are explained as follows:

Item	Description
OUI Address	Enter OUI MAC address of monitored IP camera. It can't be edited in edit dialog.
Description	Enter a description of the specified MAC address to the surveillance VLAN OUI table.
Add	Click it to create a new voice OUI based on the settings configured above.
Edit	 - Modify OUI setting for surveillance VLAN.  - Click it to remove the selected OUI entry.

II-5-7 GVRP

II-5-7-1 Property

This page allows the network administrator to configure registration mode (e.g., Normal, Fixed or Forbidden) of GVRP (GARP VLAN Registration Protocol) for each GE port.

Such function can eliminate unnecessary network traffic and prevent any attempt to transmit information to unregistered users.

Port	State	VLAN Creation	Registration	Edit
GE1	Disabled	Enabled	Normal	
GE2	Disabled	Enabled	Normal	
GE3	Disabled	Enabled	Normal	
GE4	Disabled	Enabled	Normal	
GE5	Disabled	Enabled	Normal	
GE6	Disabled	Enabled	Normal	
GE7	Disabled	Enabled	Normal	
GE8	Disabled	Enabled	Normal	

Available settings are explained as follows:

Item	Description
State	Enabled - Click it to enable the port settings for such VLAN. Disabled - Click it to disable the port settings for such VLAN.
Timeout	Display the current time status for GVRP.
Apply	Apply the settings to the switch.
Edit	- Click it to modify settings for the selected port.

State - Select Enabled or Disabled for such port.

VLAN Creation -Select Enabled or Disabled.

Mode - There are three modes to be specified.

- Normal - Default setting. All packets can pass through the selected GE port.
- Fixed - The selected GE port only sends static VLAN information to neighboring device and allows static VLAN packet to pass through.
- Forbidden - The selected GE port only allows default VLAN packet to pass through.

II-5-7-2 Membership

This page display information about membership for GVRP.

The screenshot shows the web interface for configuring GVRP Membership. The top navigation bar includes 'Auto Logout : Off', 'Admin', 'P2121', and the time '09:25:34'. The breadcrumb trail is 'Switch LAN > VLAN Management > GVRP > Membership'. The left sidebar contains a menu with 'GVRP' highlighted. The main content area has two tabs: 'Property' and 'Membership'. Below the tabs is a table with columns: 'VLAN', 'Member', 'Dynamic Member', and 'Type'. The table is currently empty, displaying the message 'No data available in table'.

II-6 EEE

This page allows a user to enable or disable port EEE (Energy Efficient Ethernet) function.

Port	Enable	Status	Modify
GE1	Disabled	Disabled	✓
GE2	Disabled	Disabled	✓
GE3	Disabled	Disabled	✓
GE4	Disabled	Disabled	✓
GE5	Disabled	Disabled	✓
GE6	Disabled	Disabled	✓
GE7	Disabled	Disabled	✓
GE8	Disabled	Disabled	✓
GE9	Disabled	Disabled	✓
GE10	Disabled	Disabled	✓

Available settings are explained as follows:

Item	Description
Port	Select one or multiple ports to configure (GE1 to GE12).
Enable	Enable -Click it to enable the EEE function. Disable - Click it to disable the EEE function.
Apply	Apply the settings to the switch.
Modify	 - Click it to modify port setting status. <div data-bbox="703 1400 1406 1758" style="border: 1px solid #ccc; padding: 10px; margin-top: 10px;"> <p style="text-align: center;">Edit Port GE1</p> <p style="text-align: center;">Enable</p> <p style="text-align: center;">Disable ▾</p> <p style="text-align: center;"> <input type="button" value="OK"/> <input type="button" value="Cancel"/> </p> </div>

II-7 Multicast

IP multicast is a technique for one-to-many communication over an IP infrastructure in a network.

To avoid the incoming data broadcasting to all GE ports, multicast is useful to transfer the data/message to specified GE ports for IGMP snooping. When VigorSwitch receives a message “subscribed” by the client, it must decide to transfer the data to specified GE ports according to the location of the client (subscribed member).

II-7-1 Properties

For the multicast packets, This page allows the network administrator to choose actions for processing the unknown multicast packets and for handling known packets with MAC address, IP address and VLAN ID.

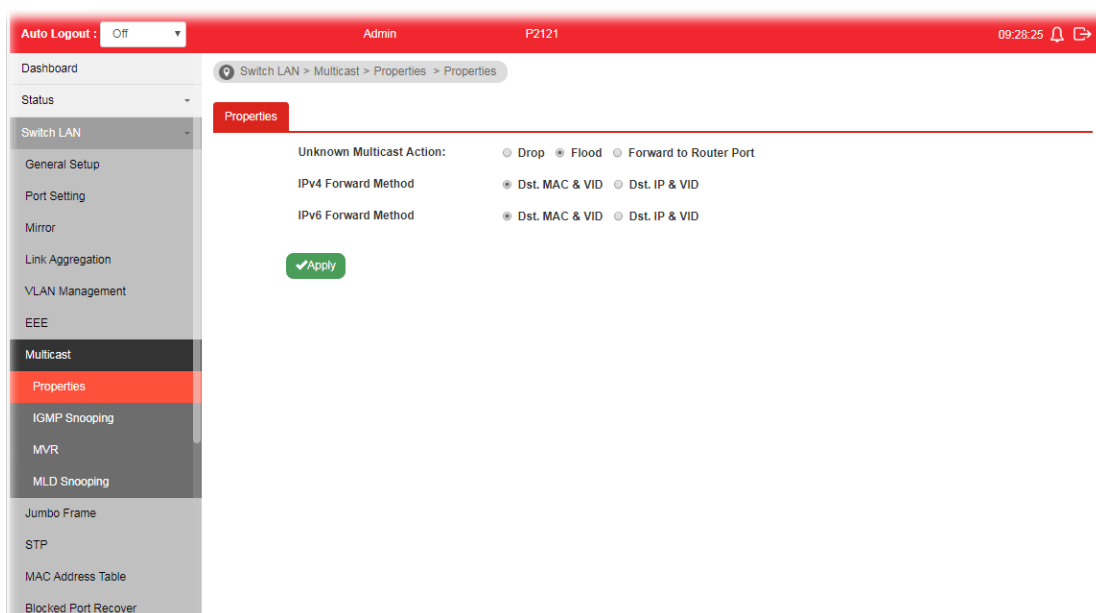

Available settings are explained as follows:

Item	Description
Unknown Multicast Action	Select an action for switch to handle with unknown multicast packet. Drop: Drop the unknown multicast data. Flood: Flood the unknown multicast data. Forward to Router port: Forward the unknown multicast data to router port.
IPv4 Forward Method / IPv6 Forward Method	Set the IPv4/IPv6 multicast forward method. Dst. MAC & VID: Forward using destination multicast MAC address and VLAN IDs. Dst. IP & VID: Forward using destination multicast IP address and VLAN ID.
Apply	Apply the settings to the switch.

II-7-2 IGMP Snooping

IGMP snooping is the process of listening to Internet Group Management Protocol (IGMP) network traffic. The feature allows a network switch to listen in on the IGMP conversation between hosts and routers. By listening to these conversations the switch maintains a map of which links need which IP multicast streams. Multicasts may be filtered from the links which do not need them and thus controls which ports receive specific multicast traffic.

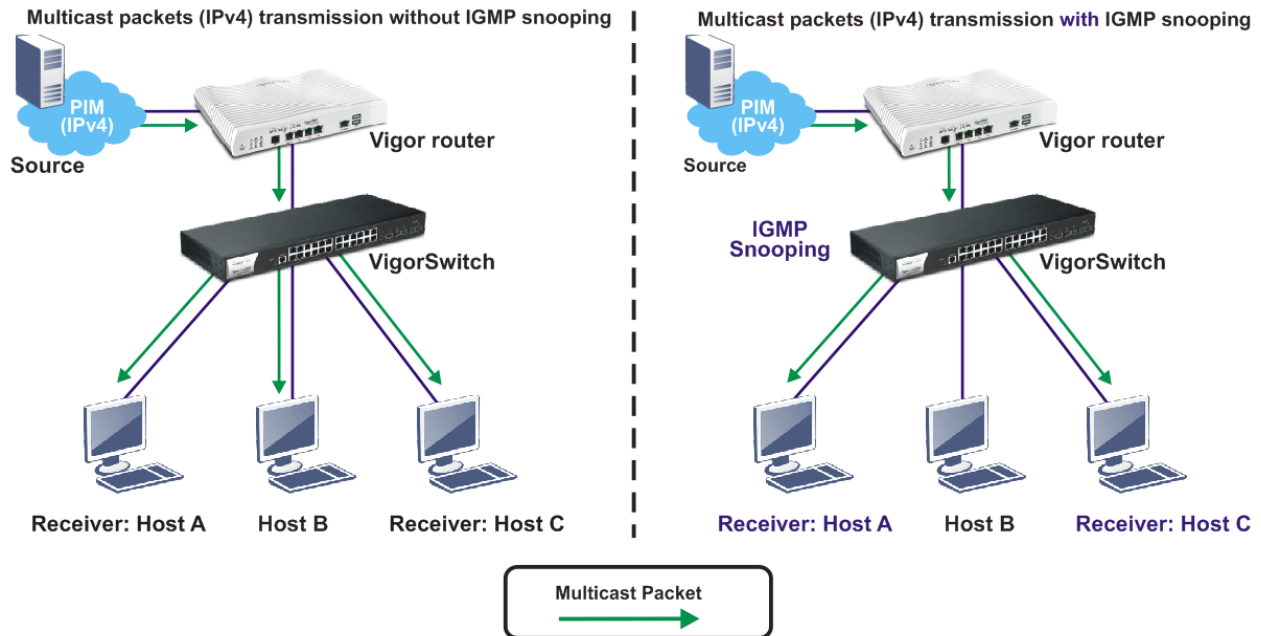

II-7-2-1 IGMP Setting

This page allows the network administrator to enable/disable IGMP function, select snooping version, and enable/disable snooping report suppression.

Entry No.	VLAN ID	IGMP Snooping	Router Ports	Query Robustness	Query Interval	Query Max Response	Last Member Count	Last Member Time
1	1	Disabled	Enabled	2	125	10	2	1

Available settings are explained as follows:

Item	Description
IGMP Snooping State	Enable - Click it to set enabling IGMP function. Disable - Click it to disable IGMP function.

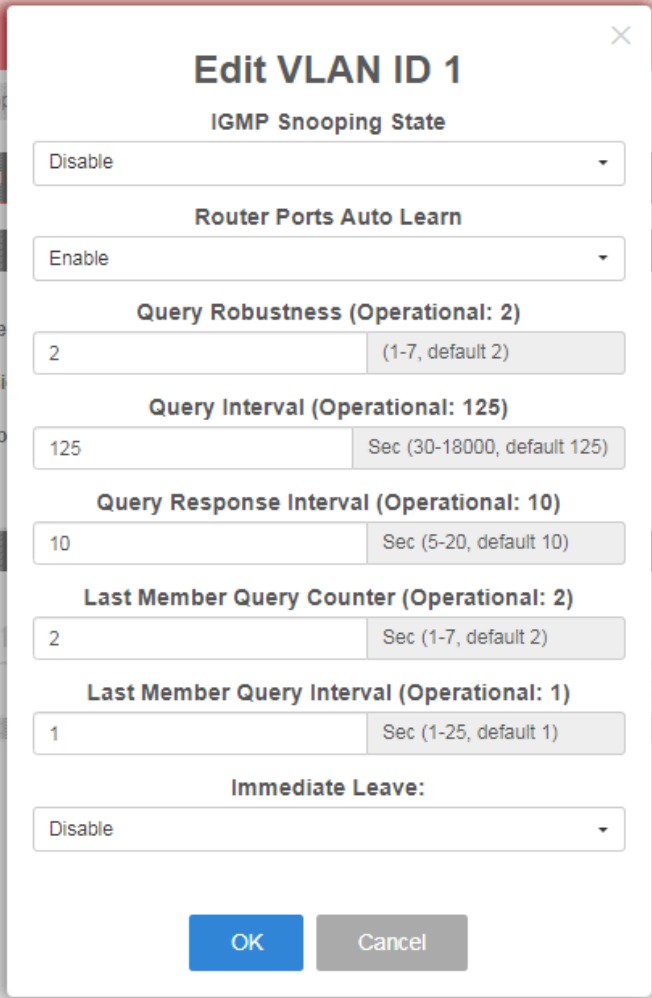
IGMP Snooping Version	Set the IGMP snooping version. v2 - Only support process IGMP v2 packet. v3 (BISS) - Support v3 basic and v2.
IGMP Snoopign Report Suppression	Click Enable to allow the switch to handle IGMP reports between router and host, suppressing bandwidth used by IGMP.
Apply	Apply the settings to the switch.
Modify	 - Click it to modify IGMP settings for selected profile. However, if IGMP Snooping State is not set as Enable , such option will be disabled.  IGMP Snooping State -Choose Enable to enable IGMP snooping function. Router Ports Auto Learn - Set the enabling status of IGMP router port learning. Choose Enable to learn router port by IGMP query. Query Robustness - Set a number which allows tuning for the expected packet loss on a subnet. Query Interval - Set the interval of querier send general query. Query Response Interval - It specifies the maximum allowed time before sending a responding report in units of 1/10 second.

Last Member Query Counter - After querying for specified times (defined here) and still not receiving any response from the subscribed member, VigorSwitch will stop transmitting data to the related GE port(s).

Last Member Query Interval - The maximum time interval between counting each member query message with no responses from any subscribed member.

Immediate Leave - Leave the multicast group immediately on the port & VLAN where leave message is sent from, regardless there is still a subscribed member or not. Click Enable to enable Fastleave function.

OK - Apply the settings to the switch.

Cancel - Close the page and return to previous page.

II-7-2-2 IGMP Querier Setting

This page allows a user to configure querier settings on specific VLAN of IGMP Snooping.

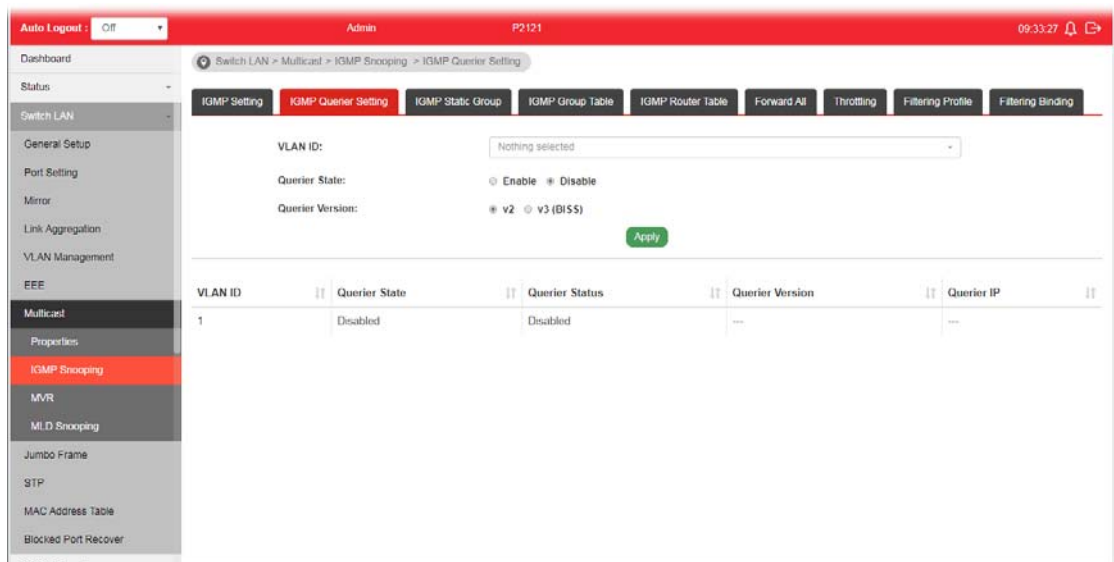

Available settings are explained as follows:

Item	Description
VLAN ID	Use the drop down list to specify a VLAN profile as IGMP Snooping querier.
Querier State	Enable - Click Enable to set the enabling status of IGMP Querier on the chosen VLAN profile. Disable - Click it to disable the function.
Querier Version	Set the query version of IGMP Querier Election on the chosen VLANs. v2 - Querier version 2. v3 - Querier version 3. Note: For maximum compatibility, it is suggested to use querier version lower than IGMP snooping version, for there is possible network mixed with IGMP v2/v3 client and v2 query message is widely understandable for those clients.
Apply	Apply the settings to the switch.

II-7-2-3 IGMP Static Group

The IGMP static group is allowed to assign a VLAN/port as a specific IPv4 multicast member. Every IPv4 multicast stream that belongs to the specified group IP address will be forwarded to the specified port/VLAN member.

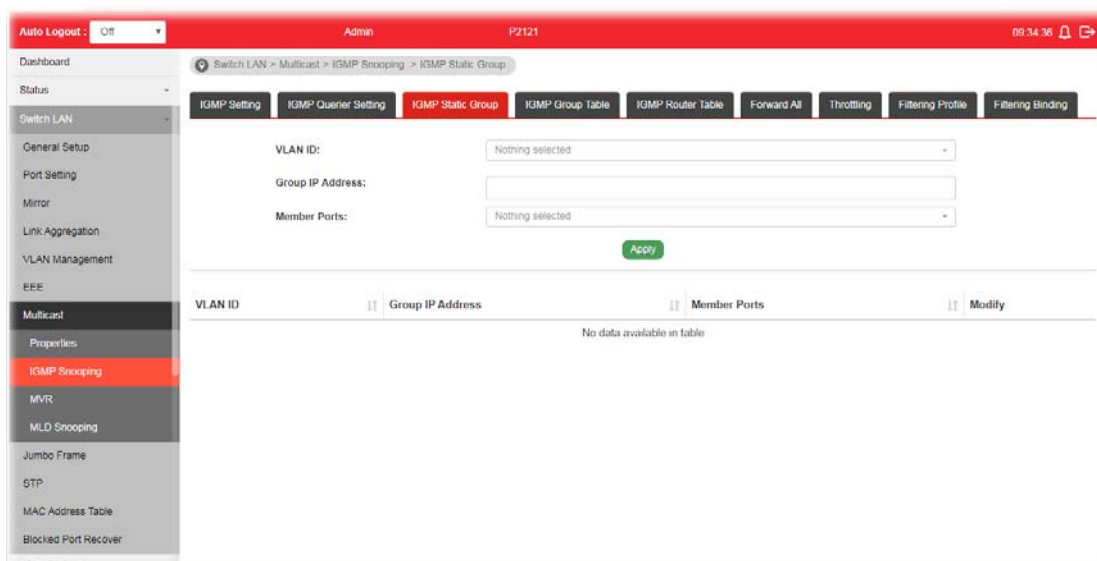

Available settings are explained as follows:

Item	Description
VLAN ID	Use the drop down list to specify a VLAN profile as IGMP Static Group.
Group IP Address	It is an identifier for the group member. Packets sent to such address will be transferred to all interfaces defined in Member Ports. Specify the IPv4 multicast address you wish to assign for the static group (defined in VLAN ID).
Member Ports	Specify the port(s) that static group with given IPv4 multicast address shall include.
Apply	Apply the settings to the switch.
Modify	 - Click it to modify settings.

II-7-2-4 IGMP Group Table

This page shows currently known and dynamically learned by IGMP snooping or shows the assigned IPv4 multicast address group in operation.

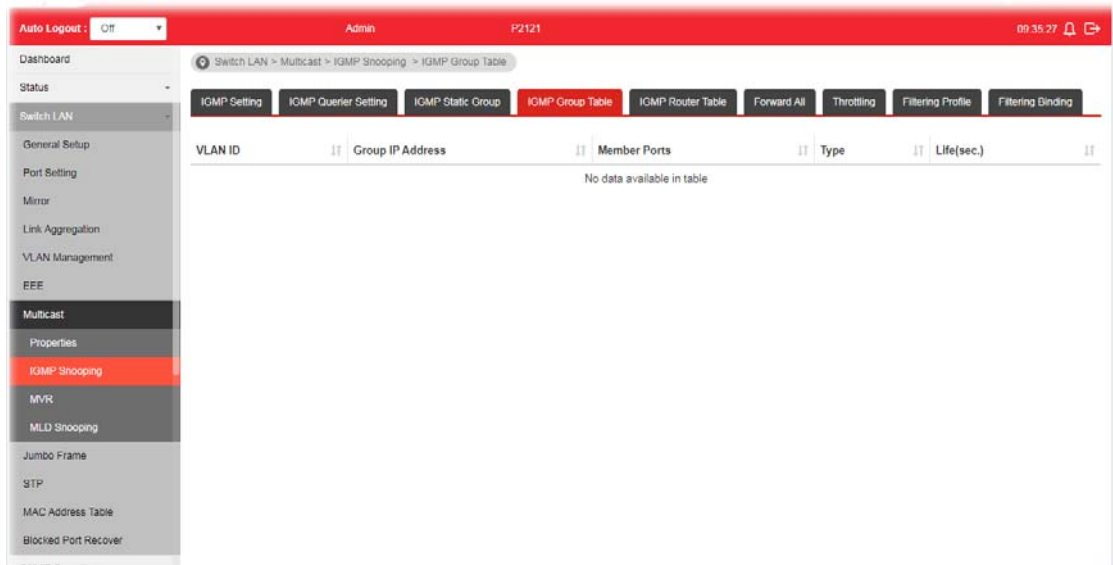

Available settings are explained as follows:

Item	Description
VLAN ID	Display the VLAN of this multicast group belongs to.
Group IP Address	Display the multicast address of this multicast group.
Member Ports	Display the port(s) where subscribing member of this multicast group belongs to.
Type	Display if it is dynamically learned or statically assigned.
Life(sec.)	Display the life time of this multicast member left if no membership report sent again.

II-7-2-5 IGMP Router Table

This page shows the IGMP querier router known to this switch.

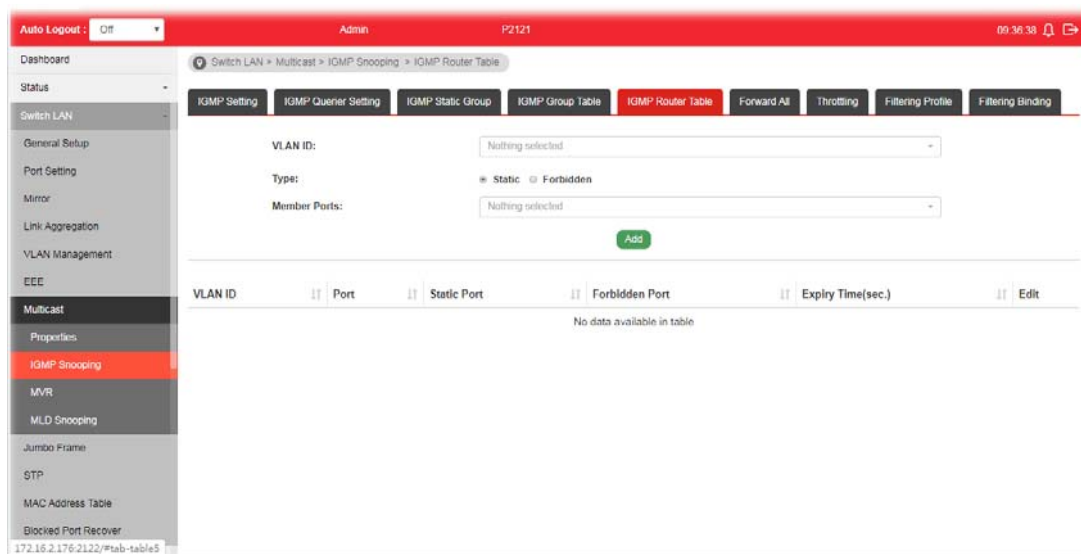

Available settings are explained as follows:



Item	Description
VLAN ID	Use the drop down list to specify a VLAN profile (created in Switch LAN>>VLAN Management>>Create Vlan) that the MLD querier belongs to.
Type	Static - Specify LAN Port (GE/LAG) to send out query to remote host. Forbidden - Use the drop down list to specify forbidden LAN Port (GE/LAG).
Member Ports	Use the drop down list to choose the uplink ports where querier router exists.
Add	Click it to display the result based on the settings configured above.
Port	Display the static port member specified in Member Ports.
Expire Time (sec.)	Display the time before querier is considered no longer existed.
Edit	Click the icon under Edit to modify the settings for the selected VLAN profile.

II-7-2-6 Forward All

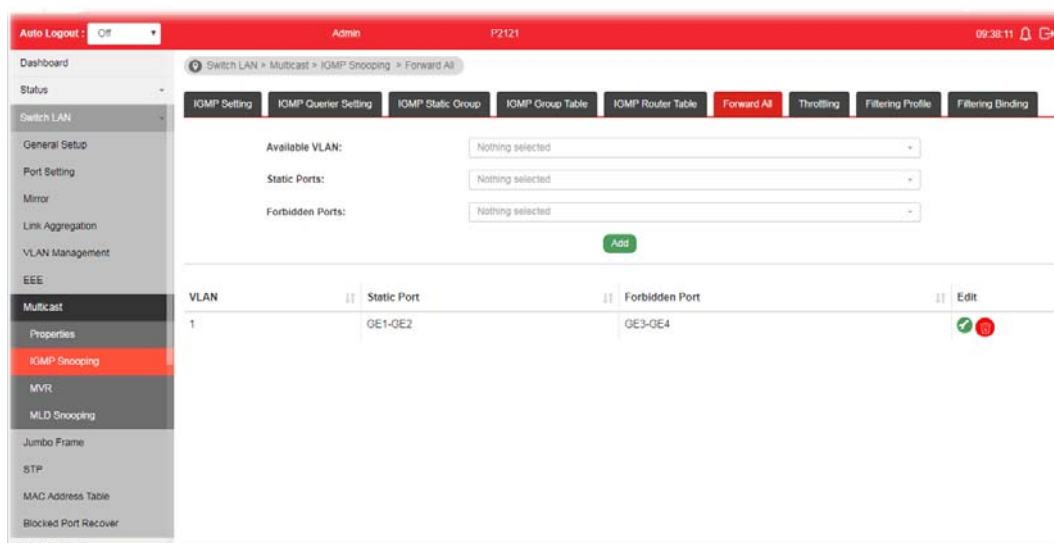
This page is allowed to determine which port(s) would like to receive the data (multicast packets) that forwarded by VigorSwitch.



Available settings are explained as follows:

Item	Description
Available VLAN	To display all of the available VLAN, the State must be set as Enabled in MLD Setting first. Use the drop down list to specify a VLAN profile (created in Switch LAN>>VLAN Management>>Create Vlan) that multicast packets will be forwarded to.
Static Ports	Use the drop down list to specify LAN Port (GE/LAG). Later, the multicast packets will be delivered to the network device connected by these ports.
Forbidden Ports	Use the drop down list to specify forbidden LAN Port (GE/LAG). Later, the multicast packets will not be delivered to the network device connected by these ports.
Add	Click it to display the result based on the settings configured above.
Edit	 - Click it to modify port setting (static port and forbidden port).  - Click it to remove the selected entry.

II-7-2-7 Throttling

The administrator can configure the user on a switch port (GE/LAG port) belonging to which multicast group and restrict the number of multicast group that the user on the switch can join. Then the administrator is able to control the network service (e.g, IP/TV service) that the user can enjoy.

The Throttling page is used for configuring the maximum number (0-255) of IGMP group that a user on a switch port can join. After defined the maximum number, each switch port interface can be set to deny the IGMP join report or set to replace randomly selected multicast interface with received IGMP join report.

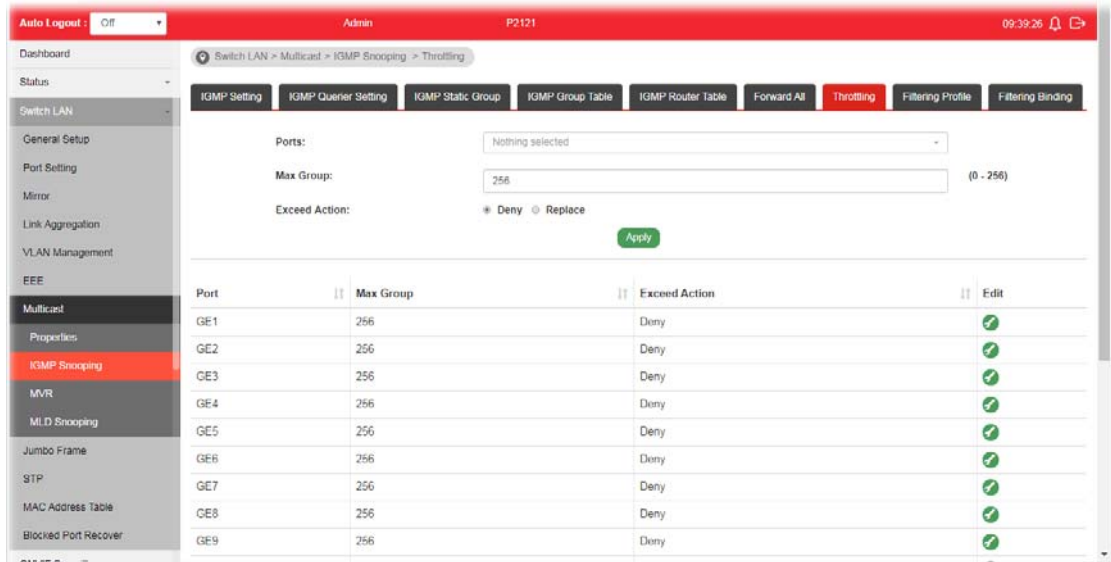

Available settings are explained as follows:

Item	Description
Ports	Use the drop down list to specify LAN Port (GE/LAG).
Max Group	Define the maximum number of IGMP group profile that a user on the switch can join. If "0" is selected, then such interface (port) can join all of the IGMP group profiles (defined in Filtering Profile).
Exceed Action	VigorSwitch will perform the action defined below when the number of IGMP join report for the specified interface exceeds value defined in Max Group. Deny - It is default setting. The IGMP join report (for multicast service) received by such interface will be discarded. Replace - When it is selected, a new group with IGMP report received will replace the existing group.
Apply	Apply the settings to the switch.
Edit	 - Click it to modify port setting (max group and exceed action).

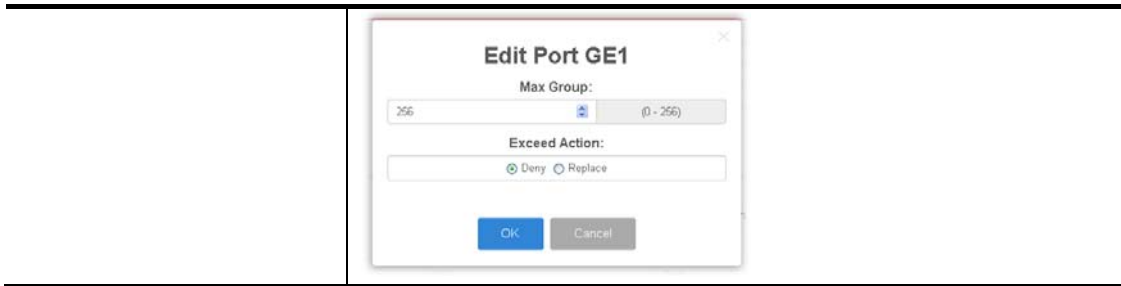

II-7-2-8 Filtering Profile

The administrator can configure the user on a switch port (GE/LAG port) belonging to which multicast group and restrict the number of multicast group that the user on the switch can join. Then the administrator is able to control the network service (e.g, IP/TV service) that the user can enjoy.

The filtering profile page allows to configure up to 128 IP-group (for multicast service) profiles (starting and ending point within an IP range shall be specified). Each IP group profile can be set for permission of / denial of network service respectively.

In addition, such filtering profile is only effective for controlling the query for multicast. It has nothing to do with the general IGMP query.

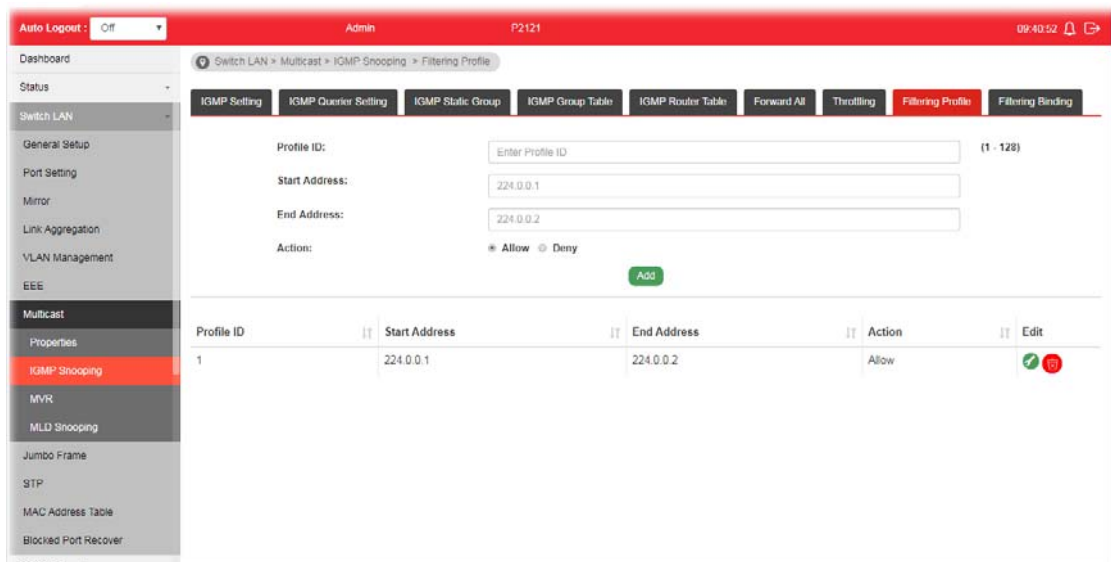

Available settings are explained as follows:

Item	Description
Profile ID	Use the drop down list to select one filtering profile (1~128) for IGMP snooping.
Start Address	Enter an IP address as the starting point for the IP range.
End Address	Enter an IP address as the ending point for the IP range.
Action	Deny - It is default setting. The forwarding request of multicast traffic will be discarded. Allow - When it is selected, the request for multicast traffic will be forwarded to the multicast group normally.
Add	Click it to display the result based on the settings configured above.
Edit	 - Click it to modify port setting (max group and exceed

action).

II-7-2-9 Filtering Binding

This page allows the network administrator to select a filtering profile for LAN/GE port to process multicast traffic.

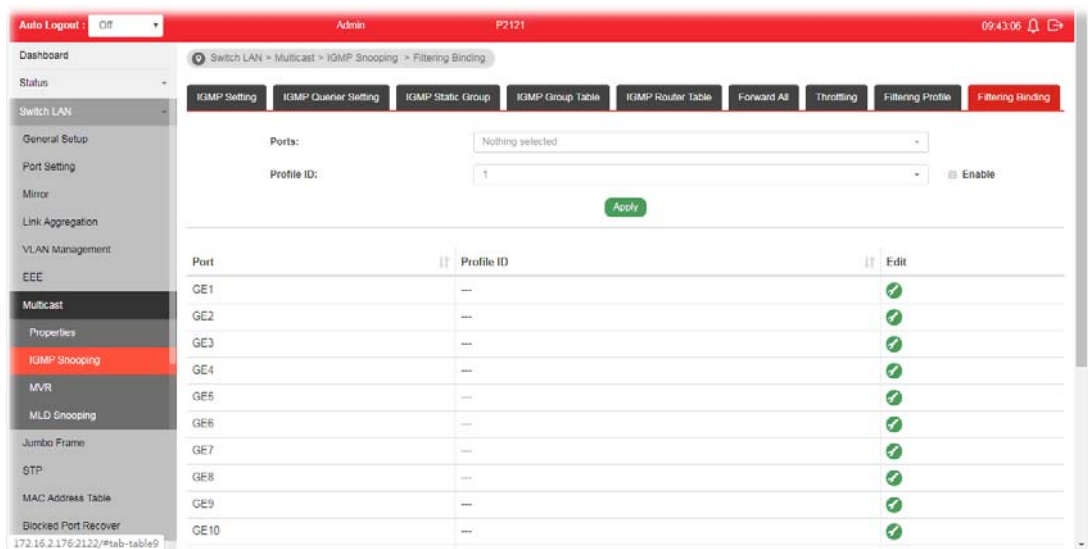

Available settings are explained as follows:

Item	Description
Ports	Use the drop down list to specify LAN Port (GE/LAG).
Profile ID	Use the drop down list to choose the filtering profile for the select port/interface. Enable - Check this box first to make profile ID selection be available for choosing.
Apply	Apply the settings to the switch.
Edit	 - Click it to modify port setting (enabling / disabling filter function and choosing a profile for such interface).

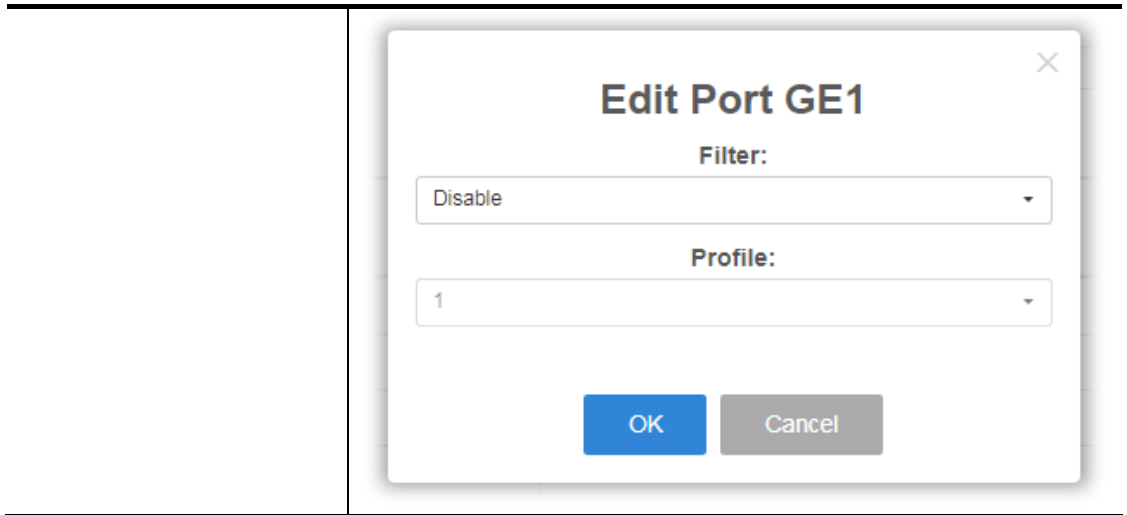

II-7-3 MVR

Multicast VLAN Registration (MVR) can route packets received in a multicast source VLAN to one or more destination VLANs. LAN users are in the destination VLANs and the multicast server is in the source VLAN.

MVR can continuously send multicast stream for traffic in the multicast VLAN, but isolate the streams from the source VLANs for bandwidth and security reasons.

In general, MVR is able to:

- Identify the MVR IP multicast streams and their associated IP multicast group.
- Intercept the IGMP messages

II-7-3-1 Property

This page allows the network administrator to configure general settings for MVR, such as enabling function, selecting VLAN ID (as source VLAN) and specify IP address(es) for receiver/LAN users.

The screenshot displays the 'MVR Property' configuration page. The left sidebar contains a navigation menu with 'MVR' highlighted. The main content area is titled 'Property Settings' and includes the following fields:

- State:** Radio buttons for 'Enable' (selected) and 'Disable'.
- VLAN ID:** A dropdown menu showing 'default(1)'.
- Mode:** Radio buttons for 'Compatible' (selected) and 'Dynamic'.
- Group Start:** A text input field containing '0.0.0.0'.
- Group Count:** A text input field containing '1', with '(1-128)' to its right.
- Query Time:** A text input field containing '1', with '(1-10 sec)' to its right.

An 'Apply' button is located below these settings. Below the settings is an 'Operational Group' table:

Operational Group	
Maximum	128
Current	0

Available settings are explained as follows:

Item	Description
State	Enabled - Click it to enable the MVR function. Disabled - Click it to disable the MVR function.
VLAN ID	Choose one VLAN profile from the drop down list as multicast source VLAN which will receive multicast data. All source ports must belong to this VLAN. The default is VLAN 1. Note: Each VLAN ID shall be configured with group address and member port (defined in MVR>>Group Address page).
Mode	There are two modes offered for MVR operation. Compatible - Multicast data received by MVR hosts (multicast server) will be forwarded to all MVR receiver ports. Dynamic - Multicast data received by MVR hosts (multicast server) on Vigor switch will be forwarded from those MVR data and client ports grouped under MVR server.

Group Start	Enter an IP address. Any multicast data sent to this IP address will be sent to all source ports on Vigor switch; and all receiver ports will accept /receive data from that multicast address.
Group Count	Select a number to configure a contiguous series of MVR group addresses (the range for count is 1 to 128; the default is 1).
Query Time	Use the drop down list to define the maximum time (1 - 10 seconds) to wait for IGMP report members on a receiver port before the port is removed from multicast group.
Apply	Apply the settings to the switch.
Operation Group	Display group information for MVR operation.

II-7-3-2 Port Setting

It is necessary to specify destination port and source port (GE/LAG) for Vigor system to perform MVR operation.

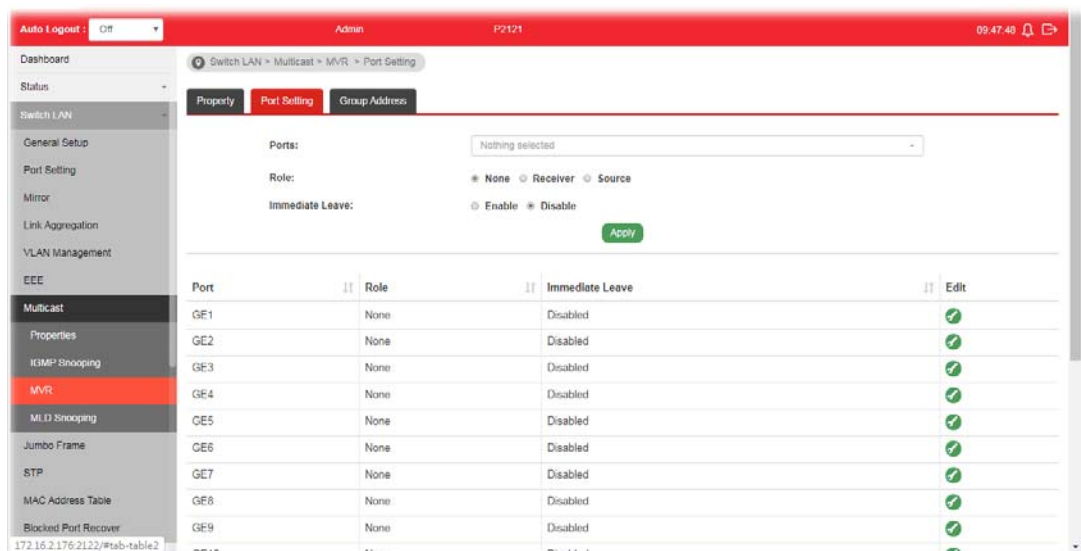

Available settings are explained as follows:

Item	Description
Ports	Use the drop down list to select LAN Port (GE/LAG). Later, each port can be set as Receiver or Source port respectively. If you do not satisfy with the port setting, simply click the Edit button to make the modification.
Role	<p>None - Nothing will be happened to the selected LAN port in MVR operation.</p> <p>Receiver - The selected port will be treated as destination port which will receive multicast data from the multicast server.</p> <p>Source - The selected port will be treated as source port which will send multicast data to the receiver port.</p>
Immediate Leave	<p>Enabled - Enable the function fo immediate leave. When the port (with the role of receiver) receives the leave message, it will be removed from multicast group to speed up leave latency.</p> <p>Disabled - Disable the function of immediate leave.</p>

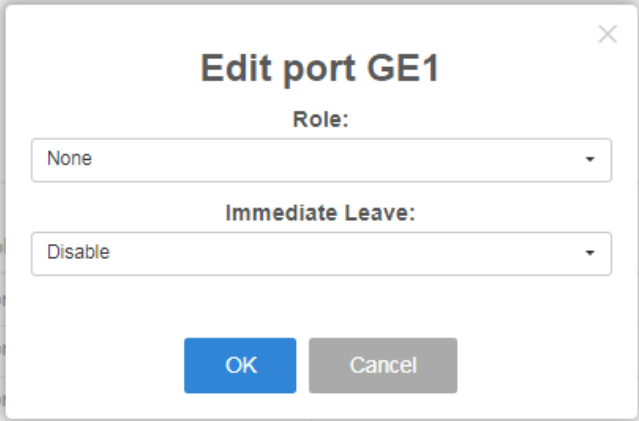
Apply	Apply the settings to the switch.
Edit	 - Click it to modify port setting (role and immediate leave). 

II-7-3-3 Group Address

This page allows the network administrator to configure IP address and specify port member for VLAN selected in MVR>>Property page.

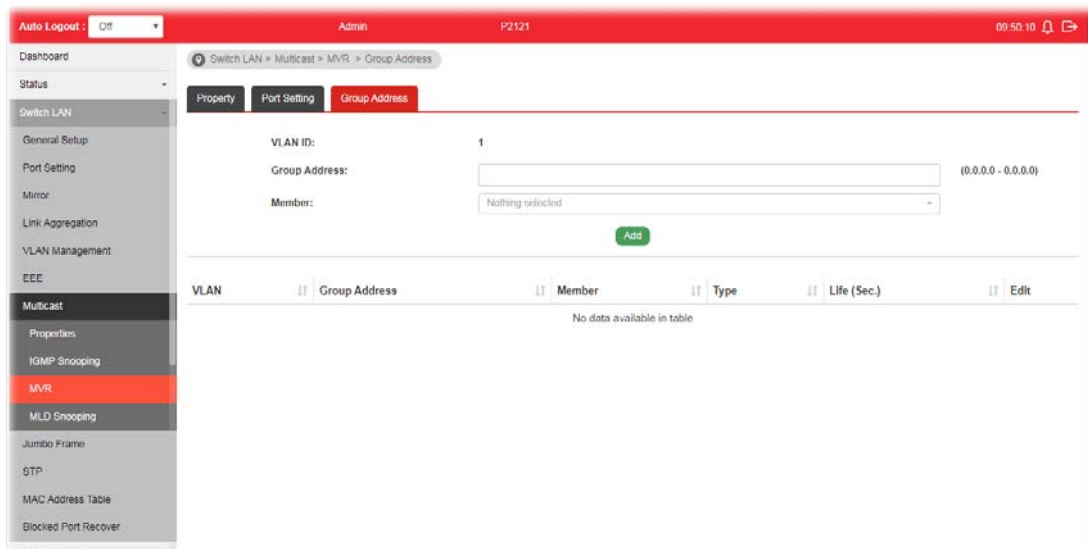

Available settings are explained as follows:

Item	Description
VLAN ID	Display the ID number of the VLAN.
Group Address	Define a range of IP address(es) with the format of "xxx.xxx.xxx.xxx - xxx.xxx.xxx.xxx".
Member	Choose GE/LAG port to be grouped under the selected VLAN.
Add	Click it to display the result based on the settings configured above.
Edit	 - Click it to modify the settings.

II-7-4 MLD Snooping

MLD snooping does the same thing as IGMP snooping. The difference is that IGMP snooping acts on IPv4 packets; MLD snooping acts on IPv6 packets. MLD snooping is the process of listening to Multicast Listener Discovery network traffic. It can examine IPv6 packets and forward these packets to designate location via VLAN port members.

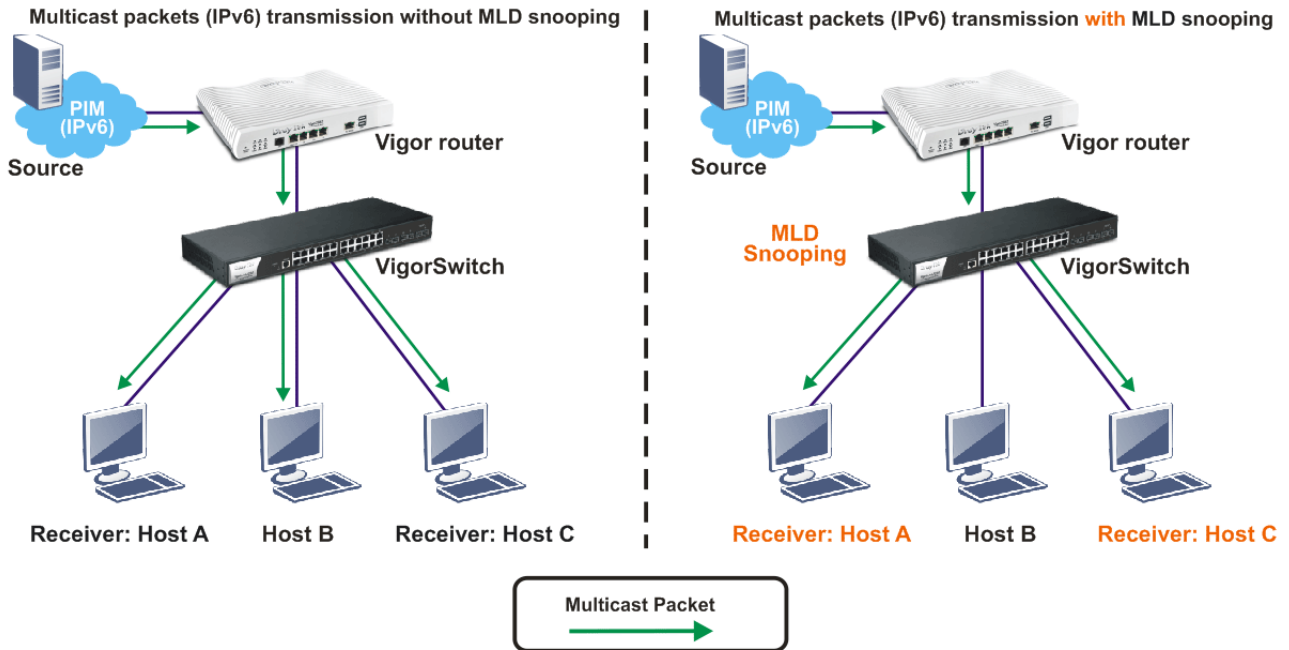

II-7-4-1 MLD Setting

This page allows the network administrator to enable/disable MLD Snooping function, select snooping version, and enable/disable snooping report suppression.

The screenshot shows the 'MLD Setting' page in the web interface. The 'Property Settings' section has the following options: State: Enable Disable; Version: MLDv1 MLDv2; Report Suppression: Enable Disable. An 'Apply' button is visible. The 'VLAN Setting' table is as follows:

VLAN ID	MLD Snooping Operational S...	Router Port Auto Learn	Query Robustness	Query Interval	Query Max Response Inte...	Last Member Query Counter	Last Member Query Interval	Immediate Leave	Edit
1	Disabled	Enabled	2	125	10	2	1	Disabled	<input checked="" type="checkbox"/>

Available settings are explained as follows:

Item	Description
State	Enabled - Click it to enable the MLD snooping function.

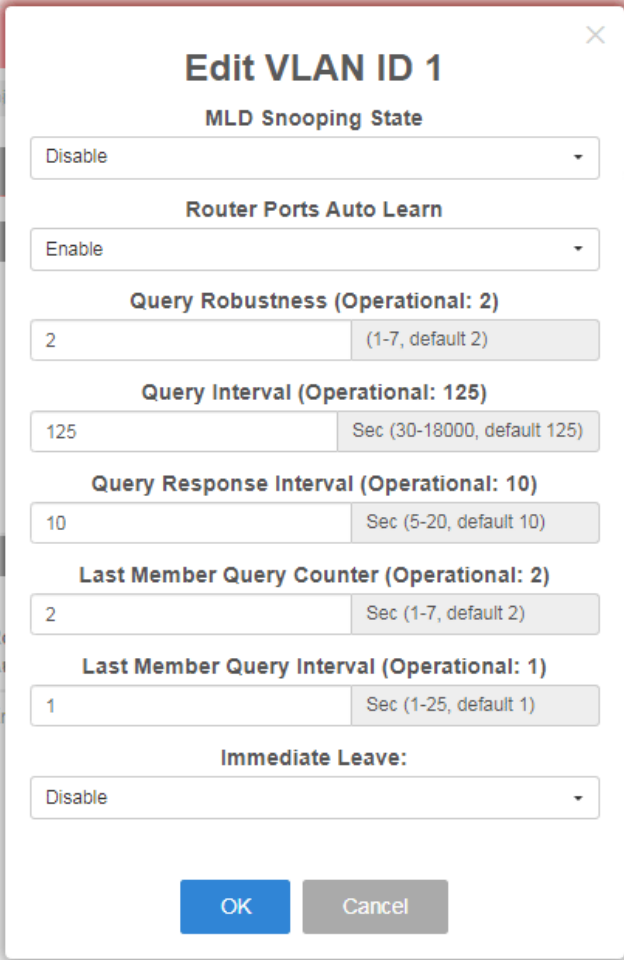
	Disabled - Click it to disable the MLD snooping function.
Version	VigorSwitch supports two versions of MLD snooping. MLDv1 - When it is selected, VigorSwitch will detect packets controlled by MLDv1 and <i>bridge</i> the traffic to IPv6 destination defined with multicast address(es). MLDv2 - When it is selected, VigorSwitch will detect packets controlled by MLDv1 and <i>forward</i> the traffic to destination defined with multicast address(es).
Report Suppression	Enabled - Click it to allow the switch to handle MLD reports between router and host, suppressing bandwidth used by MLD. Disabled - Click it to disable the function.
Apply	Click it to display the result based on the settings configured above.
Edit	 - Click it to modify the settings for the selected VLAN ID (GE/LAG port).  <p>MLD Snooping State - Enable/disable the MLD snooping function for the selected port.</p> <p>Router Ports Auto Learn -Set the enabling status of IGMP router port learning. Choose Enable to learn router port by MLD query.</p> <p>Query Robustness - Set a number which allows tuning for the expected packet loss on a subnet.</p> <p>Query Interval - Specify the time interval for VigorSwitch to</p>

send out general MLD query to the host (responsible for responding). Later, based on the response, VigorSwitch can forward the traffic through ports in VLAN.

Query Response Interval - Specify the time interval for VigorSwitch to receive the query response from the host. If time is up and no response received, the packets will be blocked and discarded.

Last Member Query Counter - After querying for specified times (defined here) and still not receiving any response from the subscribed member, VigorSwitch will stop transmitting data to the related GE port(s).

Last Member Query Interval - The maximum time interval between counting each member query message with no responses from any subscribed member.

Immediate Leave - Click **Enable** to enable the function of immediate leave. When the GE/LAG port receives the leave message, it will be removed from multicast group to speed up leave latency.

OK - Apply the settings to the switch.

Cancel - Close the page and return to previous page.

II-7-4-2 MLD Static Group

The MLD static group is allowed to assign a VLAN/port as a specific IPv6 multicast member. Every IPv6 multicast stream that belongs to the specified group IP address will be forwarded to the specified port/VLAN member.

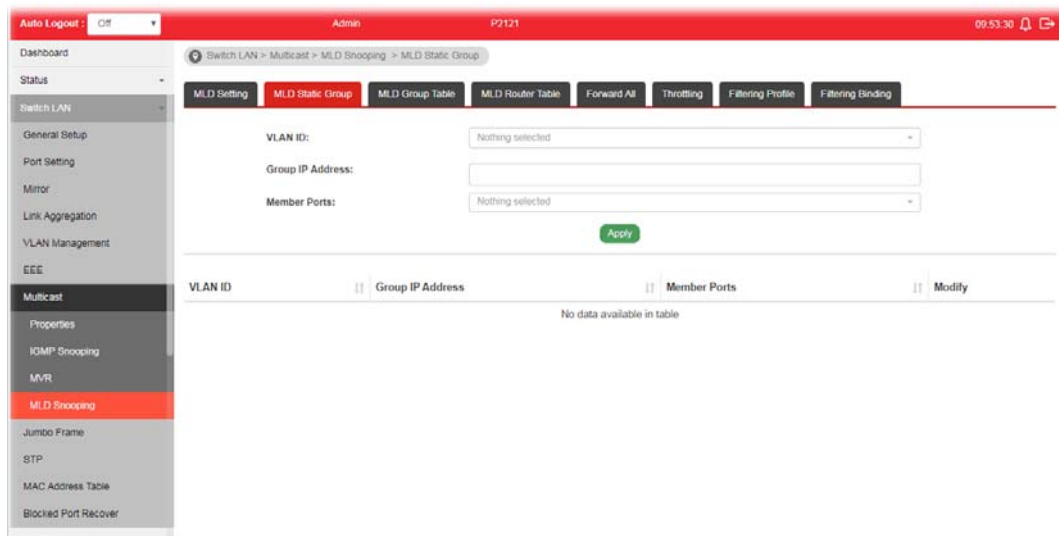

Available settings are explained as follows:

Item	Description
VLAN ID	Use the drop down list to specify a VLAN profile (created in Switch LAN>>VLAN Management>>Create Vlan) as MLD Static Group. However, if State in MLD Setting is not set as Enabled , such option will be disabled and no ID can be selected.
Group IP Address	It is an identifier for the group member. Packets sent to such address will be transferred to all interfaces defined in Member Ports. Specify the IPv6 multicast address you wish to assign for the

	static group (defined in VLAN ID).
Member Ports	Use the drop down list to specify interaces (GE/LAG) for receiving the packets from group IP address.
Add	Click it to display the result based on the settings configured above.

II-7-4-3 MLD Group Table

This page shows currently known and dynamically learned by MLD snooping or shows the assigned IP6 multicast address group in operation.

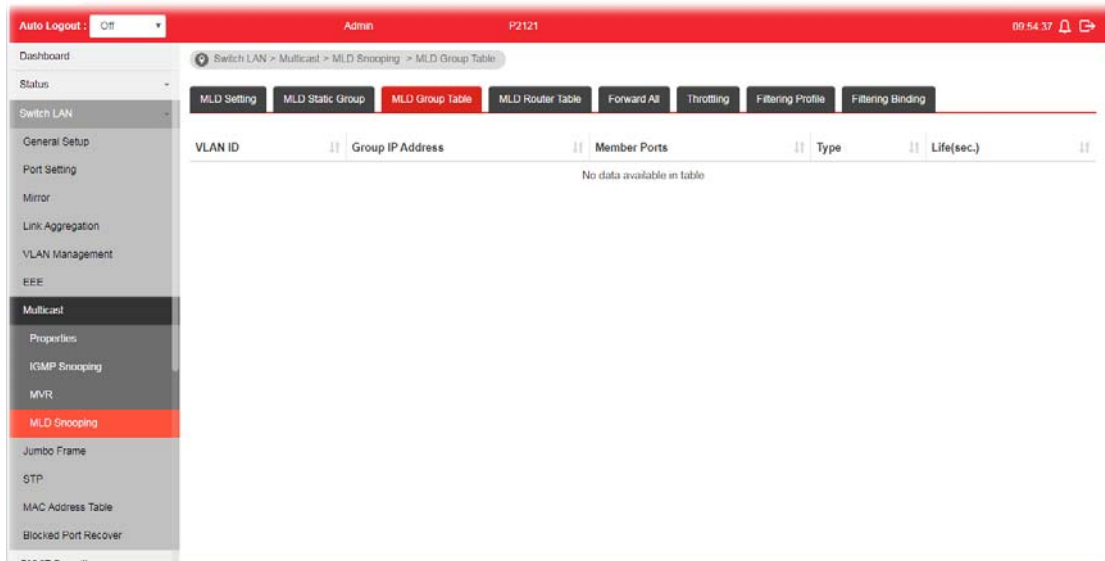

Available settings are explained as follows:

Item	Description
VLAN ID	Display the name of VLAN configured in MLD Static Group.
Group IP Address	Display the IP address defined in MLD Static Group.
Member Ports	Display all of the interfaces defined in MLD Static Group.
Type	Display if it is dynamically learned or statically assigned.
Life(sec.)	Display the life time of this multicast member left if no membership report sent again.

II-7-4-4 MLD Router Table

This page is allowed to configure VLAN profile by specifying static/forbidden ports for the router (MLD querier).

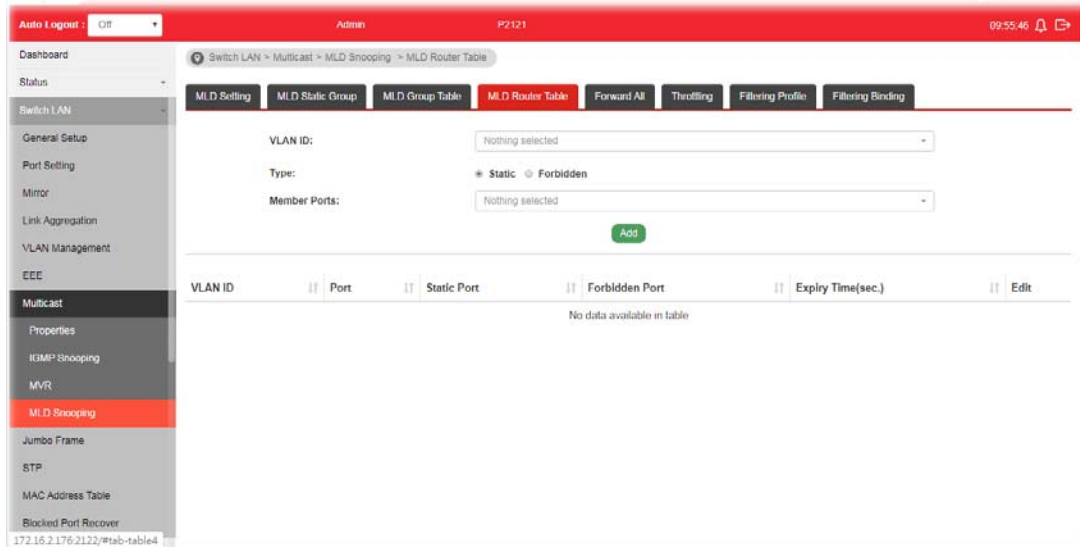

Available settings are explained as follows:



Item	Description
VLAN ID	Use the drop down list to specify a VLAN profile (created in Switch LAN>>VLAN Management>>Create Vlan) that the MLD querier belongs to.
Type	Static - Specify LAN Port (GE/LAG) to send out query to remote host. Forbidden - Use the drop down list to specify forbidden LAN Port (GE/LAG).
Member Ports	Use the drop down list to choose the uplink ports where querier router exists.
Add	Click it to display the result based on the settings configured above.
Port	Display the static port member specified in Member Ports.
Expire Time (sec.)	Display the time before querier is considered no longer existed.
Edit	 - Click it to modify the settings for the selected entry.

II-7-4-5 Forward All

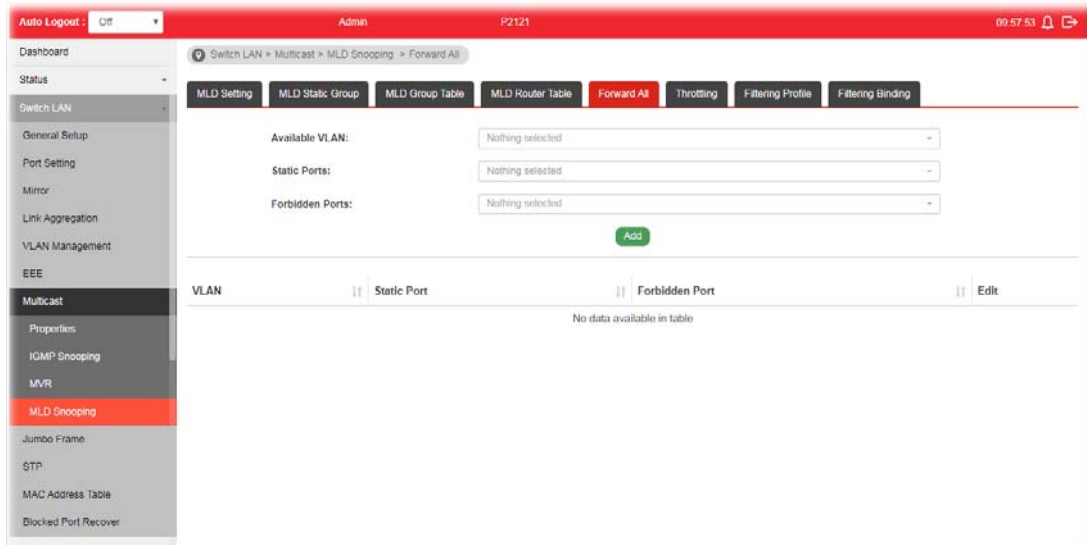
This page is allowed to determine which port(s) would like to receive the data (multicast packets) that forwarded by VigorSwitch.



Available settings are explained as follows:

Item	Description
Available VLAN	To display all of the available VLAN, the State must be set as Enabled in MLD Setting first. Use the drop down list to specify a VLAN profile (created in Switch LAN>>VLAN Management>>Create Vlan) that multicast packets will be forwarded to.
Static Ports	Use the drop down list to specify LAN Port (GE/LAG). Later, the multicast packets will be delivered to the network device connected by these ports.
Forbidden Ports	Use the drop down list to specify forbidden LAN Port (GE/LAG). Later, the multicast packets will not be delivered to the network device connected by these ports.
Add	Click it to display the result based on the settings configured above.
Edit	 - Click it to modify port setting (static port and forbidden port).  - Click it to remove the selected entry.

II-7-4-6 Throttling

The administrator can configure the user on a switch port (GE/LAG port) belonging to which multicast group and restrict the number of multicast group that the user on the switch can join. Then the administrator is able to control the network service (e.g, IP/TV service) that the user can enjoy.

The Throttling page is used for configuring the maximum number (0-255) of MLD group that a user on a switch port can join. After defined the maximum number, each switch port

interface can be set to deny the MLD join report or set to replace randomly selected multicast interface with received MLD join report.

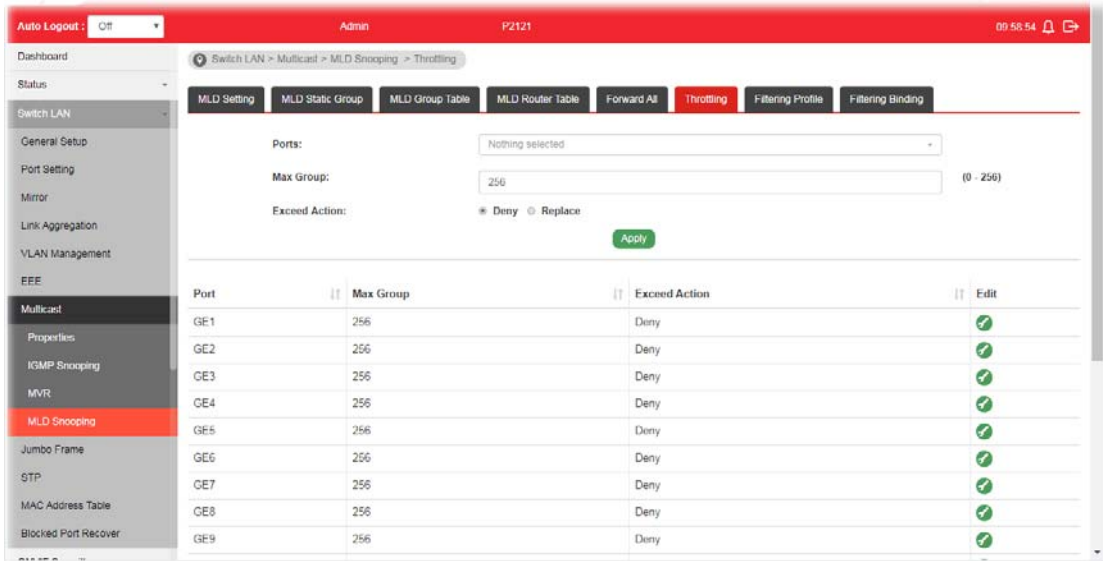

Available settings are explained as follows:

Item	Description
Ports	Use the drop down list to specify LAN Port (GE/LAG) for applying throttling feature.
Max Group	Define the maximum number of MLD group profile that a user on the switch can join. If "0" is selected, then such interface (port) can join all of the MLD group profiles (defined in Filtering Profile).
Exceed Action	VigorSwitch will perform the action defined below when the number of MLD join report for the specified interface exceeds value defined in Max Group. Deny - It is default setting. The MLD join report (for multicast service) received by such interface will be discarded. Replace - When it is selected, a new group with MLD report received will replace the existing group.
Apply	Apply the settings to the switch.
Edit	 - Click it to modify the settings for the selected entry.

II-7-4-7 Filtering Profile

The administrator can configure the user on a switch port (GE/LAG port) belonging to which multicast group and restrict the number of multicast group that the user on the switch can join. Then the administrator is able to control the network service (e.g, IP/TV service) that the user can enjoy.

The filtering profile page allows to configure up to 128 IP-group (for multicast service) profiles (starting and ending point within an IP range shall be specified). Each IP group profile can be set for permission of / denial of network service respectively.

In addition, such filtering profile is only effective for controlling the query for multicast traffic. It has nothing to do with the general MLD query.

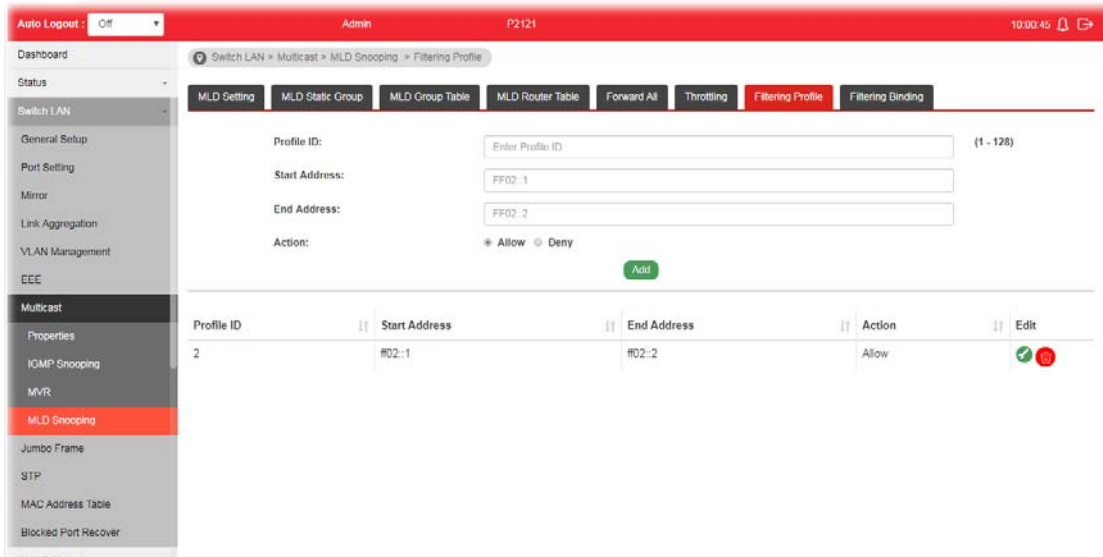

Available settings are explained as follows:

Item	Description
Profile ID	Use the drop down list to select one filtering profile (1~128) for MLD snooping.
Start Address	Enter an IP address as the starting point for the IP range.
End Address	Enter an IP address as the ending point for the IP range.
Action	Deny - It is default setting. The forwarding request of multicast traffic will be discarded. Allow - When it is selected, the request for multicast traffic will be forwarded to the multicast group normally.
Add	Click it to display the result based on the settings configured above.
Edit	 - Click it to modify the settings for the selected entry.

II-7-4-8 Filtering Binding

This page allows the network administrator to select a filtering profile for LAN/GE port to process multicast traffic.

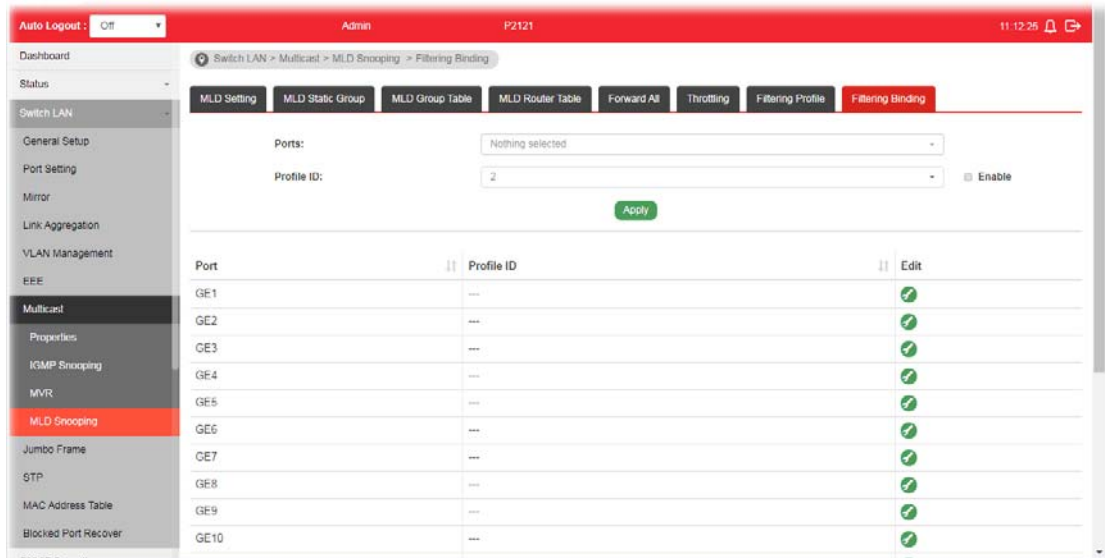

Available settings are explained as follows:

Item	Description
Ports	Use the drop down list to specify LAN Port (GE/LAG).
Profile ID	Use the drop down list to choose the filtering profile for the select port/interface. Enable - Check this box first to make profile ID selection be available for choosing.
Apply	Apply the settings to the switch.
Edit	 - Click it to modify port setting (enabling / disabling filter function and choosing a profile for such interface). <div data-bbox="699 1406 1417 1877" style="border: 1px solid #ccc; padding: 10px; margin-top: 10px;"> <div style="text-align: right; font-size: 20px;">✕</div> <h3 style="text-align: center;">Edit Port GE1</h3> <p style="text-align: center;">Filter:</p> <div style="text-align: center; border: 1px solid #ccc; padding: 5px; width: 100%;">Enable ▾</div> <p style="text-align: center;">Profile:</p> <div style="text-align: center; border: 1px solid #ccc; padding: 5px; width: 100%;">1 ▾</div> <div style="display: flex; justify-content: center; gap: 20px; margin-top: 10px;"> OK Cancel </div> </div>

II-8 Jumbo Frame

This page allows a user to configure switch port jumbo frame settings.

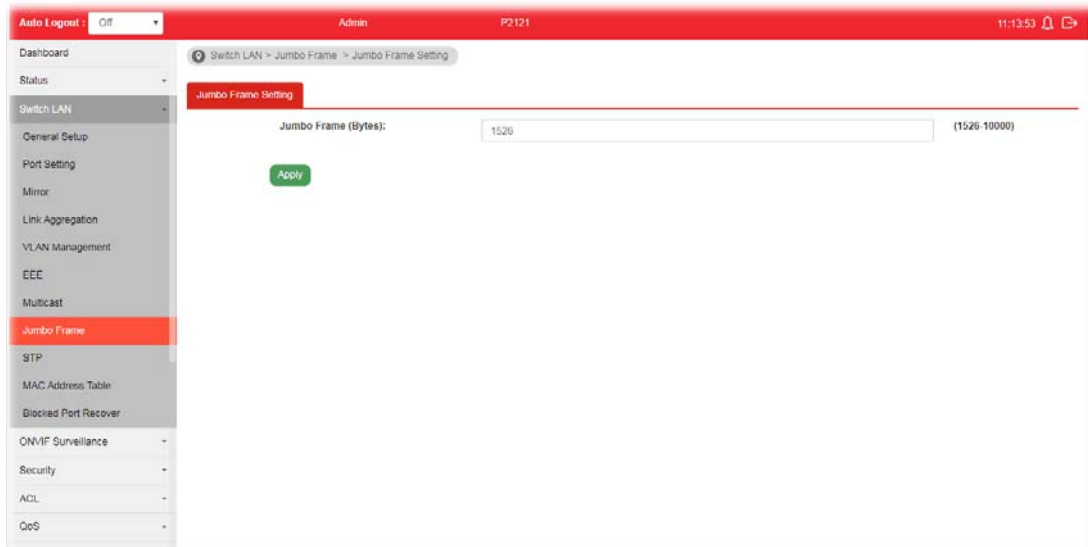

Available settings are explained as follows:

Item	Description
Jumbo Frame (Bytes)	Enter Jumbo frame size. The valid range is 1526 bytes - 9216 bytes.
Apply	Apply the settings to the switch.

II-9 STP

The Spanning Tree Protocol (STP) is a network protocol that ensures a loop-free topology for any bridged Ethernet local area network.

Bridge Protocol Data Units (BPDUs) are frames that contain information about the Spanning Tree Protocol (STP). Switches send BPDUs using a unique MAC address from its origin port and a multicast address as destination MAC (01:80:C2:00:00:00, or 01:00:0C:CC:CC:CD for Per VLAN Spanning Tree).

For STP algorithms to function, the switches need to share information about themselves and their connections. What they share are bridge protocol data units (BPDUs).

BPDUs are sent out as multicast frames to which only other layer 2 switches or bridges are listening. If any loops (multiple possible paths between switches) are found in the network topology, the switches will co-operate to disable a port or ports to ensure that there are no loops; that is, from one device to any other device in the layer 2 network, only one path can be taken.

II-9-1 Properties

This page allows a user to configure and display Spanning Tree Protocol (STP) property configuration.

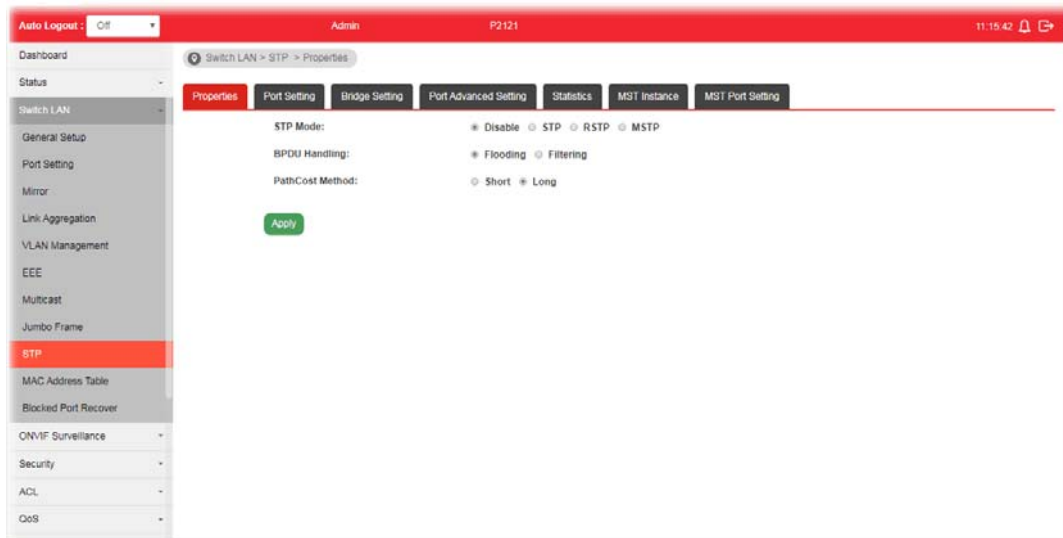

Available settings are explained as follows:

Item	Description
STP Mode	Set the operating mode of Spanning Tree (STP). Disabled - Disable the STP operation. STP - Enable the Spanning Tree (STP) operation. RSTP - Enable the Rapid Spanning Tree (RSTP) operation. MSTP - Enable the Multiple Spanning Tree Protocol (MSTP) operation.
BPDUs Handling	Specify the BPDUs forward method when the STP is disabled. Filtering - Filter the BPDUs when STP is disabled. Flooding - Flood the BPDUs when STP is disabled.

PathCost Method	Specify the path cost method. Long - Specifies that the default port path costs are within the range: 1~200,000,000. Short - Specifies that the default port path costs are within the range: 1~65,535.
Apply	Apply the settings to the switch.

II-9-2 Port Setting

This page allows the user to configure and display Spanning Tree Protocol (STP) port settings.

The screenshot shows the 'Port Setting' configuration page for STP. The configuration fields are as follows:

- Ports: Nothing selected
- Path Cost (0 = Auto): 0
- Priority: 128
- Edge Port: Yes No
- P2P Option: Auto Yes No
- BPDU Filter: Yes
- BPDU Guard: Yes

Below the configuration fields is a table showing the current settings for ports CE1 and GE2:

Port	Admin Enable	Path Cost	Priority	Edge Port	P2P Option	BPDU Filter	BPDU Guard	Edit
CE1	Enabled	0	128	No	Auto	Disabled	Disabled	<input checked="" type="checkbox"/>
GE2	Enabled	0	128	No	Auto	Disabled	Disabled	<input checked="" type="checkbox"/>

Available settings are explained as follows:

Item	Description
Ports	Use the drop down to specify the interface ID or the list of interface IDs.
Path Cost (0=Auto)	Path cost is the cost of transmitting a frame on to a LAN through that port. It is recommended to assign this value according to the speed of the bridge. The slower the media, the higher the cost. Entering 0 means the switch will automatically assign a value.
Priority	Specify a priority value for the switch. The smaller the priority value, the higher the priority and greater chance of becoming the root.
Edge Port	In the edge mode, the interface would be put into the Forwarding state immediately upon link up. If the edge mode is enabled for the interface and there are BPDUs received on the interface, the loop might be occurred in the short time before the STP state change. Yes - Enable the function. No - Disable the function.
P2P Option	Auto - VigorSwitch determines the STP of link type for this port automatically. Yes - It means the STP of link type on this port is full-duplex and directly connect to another switch or host.

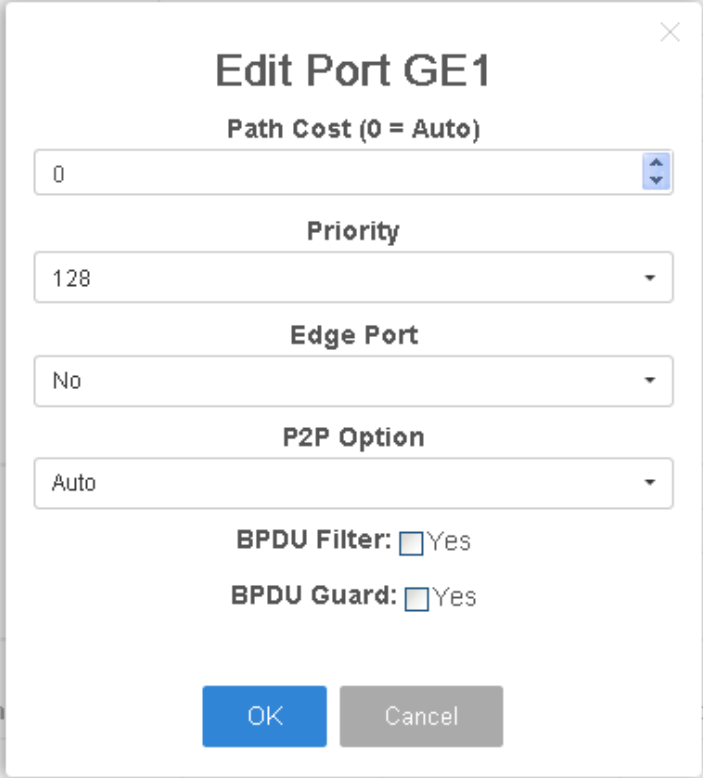
	No - It means the STP of link type on this port is "not" full-duplex and "does not" directly connect to another switch or host.
BPDU Filter	Yes - Drop all BPDU packets and no BPDU will be sent.
BPDU Guard	Yes - BPDU Guard further protects your switch by turning this port into error state and shutdown if any BPDU received from this port. Check it to enable such function.
Apply	Apply the settings to the switch. After clicking it, the settings configured above will be shown on the table below.
Ports	Use the drop down to specify the interface(s) for applying the function of Migrate .
Migrate	Click it to force the port(s) specified above to send one RSTP BPDU (Rapid Spanning Tree Protocol Bridge Protocol Data Unit).
Admin Enable	YES - Such port is managed by VigorSwitch.
Edit	Click it to modify the settings for the selected GE port. 

II-9-3 Bridge Setting

This page allows the network administrator to configure required information to negotiate with other VigorSwitch for determining the bridge switch.

Item	Value	Range
Priority	32768	
Forward Delay	15	(4-30)
Max Age	20	(6-40)
Tx Hold Count	6	(1-10)
Hello Time	2	(1-10)

Bridge Identifier	32768/ 00:1D:AA:00:2B:0A
Designated Root Bridge	0/ 0:00:00:00:00:00
Root Path Cost	0
Designated Bridge	0/ 0:00:00:00:00:00
Root Port	0 / 0
Max Hops	20
Remaining Hops	0
Last Topology Change	0

Available settings are explained as follows:

Item	Description
Priority	Specify the bridge priority. The valid range is from 0 to 61440, and the value should be the multiple of 4096. It ensures the probability that the switch is selected as the root bridge, and the lower value has the higher priority for the switch to be selected as the root bridge of the topology.
Forward Delay	Specify the STP forward delay time, which is the amount of time that a port remains in the Listening and Learning states before it enters the Forwarding state. Its valid range is from 4 to 10 seconds.
Max Age	Specify the time interval in seconds for a switch to wait the configuration messages, without attempting to redefine its own configuration.
Tx Hold Count	Specify the tx-hold-count used to limit the maximum numbers of packets transmission per second. The valid range is from 1 to 10.
Hello Time	Specify the STP hello time in second to broadcast its hello message to other bridge by Designated Ports. Its valid range is from 1 to 10 seconds.
Apply	Apply the settings to the switch.

II-9-4 Port Advanced Setting

This page allows user to edit general setting of STP CIST port and browser CIST port status.

Port	Identifier (Priority/ID)	Path Cost Conf/Oper	Designated R...	Root Path Cost	Designated B...	Edge Port Conf/Oper	P2P Option Conf/Oper	Port Role	Port State	Edit
GE1	128 / 1	0 / 20000	0 / 00:00:00:00:0	0	0 / 00:00:00:00:0	No / No	Auto / No	Disabled	Disabled	✓
GE2	128 / 2	0 / 20000	0 / 00:00:00:00:0	0	0 / 00:00:00:00:0	No / No	Auto / Yes	Disabled	Forwarding	✓
GE3	128 / 3	0 / 20000	0 / 00:00:00:00:0	0	0 / 00:00:00:00:0	No / No	Auto / No	Disabled	Disabled	✓
GE4	128 / 4	0 / 20000	0 / 00:00:00:00:0	0	0 / 00:00:00:00:0	No / No	Auto / Yes	Disabled	Forwarding	✓
GE5	128 / 5	0 / 20000	0 / 00:00:00:00:0	0	0 / 00:00:00:00:0	No / No	Auto / No	Disabled	Disabled	✓
GE6	128 / 6	0 / 20000	0 / 00:00:00:00:0	0	0 / 00:00:00:00:0	No / No	Auto / No	Disabled	Disabled	✓
GE7	128 / 7	0 / 20000	0 / 00:00:00:00:0	0	0 / 00:00:00:00:0	No / No	Auto / No	Disabled	Disabled	✓
GE8	128 / 8	0 / 20000	0 / 00:00:00:00:0	0	0 / 00:00:00:00:0	No / No	Auto / Yes	Disabled	Forwarding	✓
GE9	128 / 9	0 / 20000	0 / 00:00:00:00:0	0	0 / 00:00:00:00:0	No / No	Auto / No	Disabled	Disabled	✓
GE10	128 / 10	0 / 20000	0 / 00:00:00:00:0	0	0 / 00:00:00:00:0	No / No	Auto / Yes	Disabled	Forwarding	✓
GE11	128 / 11	0 / 20000	0 / 00:00:00:00:0	0	0 / 00:00:00:00:0	No / No	Auto / No	Disabled	Disabled	✓
GE12	128 / 12	0 / 20000	0 / 00:00:00:00:0	0	0 / 00:00:00:00:0	No / No	Auto / No	Disabled	Disabled	✓
LAG1	128 / 13	0 / 20000	0 / 00:00:00:00:0	0	0 / 00:00:00:00:0	No / No	Auto / No	Disabled	Disabled	✓
LAG2	128 / 14	0 / 20000	0 / 00:00:00:00:0	0	0 / 00:00:00:00:0	No / No	Auto / No	Disabled	Disabled	✓

Available settings are explained as follows:

Item	Description
Port	Display the interface number for GE and LAG.
Identifier(Priority/ID)	Display the spanning tree port identifier.
Path Cost Conf/Oper	Display current path cost of given port.
Designated Root Bridge	Display the identifier of designated root bridge.
Root Path Cost	Display the operational root path cost.
Designated Bridge	Display the identifier of next bridge on this port.
Edge Port Conf/Oper	Display if this port is configured as Edge of STP network, for speed up link up.
P2P MAC Conf/Oper	Display if this port is configured as point to point link to another switch or host.
Port Role	Display current port role on the specified port. The possible values will be: "Disabled", "Root", "Designated", "Alternative", and "Backup".
Port State	Display current port state on the specified port. The possible values will be: "Disabled", "Discarding", "Learning", and "Forwarding".
Edit	Click it to modify the priority setting for the selected GE port / LAG port.

II-9-5 Statistics

This page displays STP statistics.

Port	Configure BPDUs Rx.	TCN BPDUs Rx.	Configure BPDUs Tx.	TCN BPDUs Tx.
GE1	0	0	0	0
GE2	0	0	0	0
GE3	0	0	0	0
GE4	0	0	0	0
GE5	0	0	0	0
GE6	0	0	0	0
GE7	0	0	0	0
GE8	0	0	0	0
GE9	0	0	0	0
GE10	0	0	0	0
GE11	0	0	0	0
GE12	0	0	0	0
LAG1	0	0	0	0
LAG2	0	0	0	0
LAG3	0	0	0	0

Available settings are explained as follows:

Item	Description
Port	Display the port number (GE / LAG).
Configure BPDUs Rx.	Display the counts of the received CONFIG BPDU.
TCN BPDUs Rx.	Display the counts of the received TCN BPDU.
Configure BPDUs Tx.	Display the counts of the transmitted CONFIG BPDU.
TCN BPDUs Rx	Display the counts of the transmitted TCN BPDU.

II-9-6 MST Instance

MSTP allows traffic of different VLAN to be mapped into different MST Instances. VigorSwitch supports up to 16 independent MST instances (0-15) with which the VLAN can be associated.

MSTI	Priority	Bridge Identifier	Designated Root	Root Port	Root Path Cost	Remaining Hop	VLAN	Edit
0	32768	32768-00:1D:AA:00:2...	0-00:00:00:00:00:00	N/A	0	0	1-4094	
1	32768	32768-00:1D:AA:00:2...	0-00:00:00:00:00:00	N/A	0	0		✓
2	32768	32768-00:1D:AA:00:2...	0-00:00:00:00:00:00	N/A	0	0		✓
3	32768	32768-00:1D:AA:00:2...	0-00:00:00:00:00:00	N/A	0	0		✓
4	32768	32768-00:1D:AA:00:2...	0-00:00:00:00:00:00	N/A	0	0		✓
5	32768	32768-00:1D:AA:00:2...	0-00:00:00:00:00:00	N/A	0	0		✓
6	32768	32768-00:1D:AA:00:2...	0-00:00:00:00:00:00	N/A	0	0		✓
7	32768	32768-00:1D:AA:00:2...	0-00:00:00:00:00:00	N/A	0	0		✓
8	32768	32768-00:1D:AA:00:2...	0-00:00:00:00:00:00	N/A	0	0		✓
9	32768	32768-00:1D:AA:00:2...	0-00:00:00:00:00:00	N/A	0	0		✓
10	32768	32768-00:1D:AA:00:2...	0-00:00:00:00:00:00	N/A	0	0		✓
11	32768	32768-00:1D:AA:00:2...	0-00:00:00:00:00:00	N/A	0	0		✓
12	32768	32768-00:1D:AA:00:2...	0-00:00:00:00:00:00	N/A	0	0		✓
13	32768	32768-00:1D:AA:00:2...	0-00:00:00:00:00:00	N/A	0	0		✓
14	32768	32768-00:1D:AA:00:2...	0-00:00:00:00:00:00	N/A	0	0		✓

Available settings are explained as follows:

Item	Description
MSTI	Display the index number of MST Instance. Each MSTI can have one or multiple VLANs.
Edit	 - Click it to modify the priority setting for the selected GE port / LAG port. <div data-bbox="689 1272 1225 2011" style="border: 1px solid #ccc; padding: 10px; margin-top: 10px;"> <p style="text-align: center;">Edit MSTI 1</p> <p style="text-align: center;">VLAN</p> <p>0 (1 - 4094, set 0 to cancel)</p> <p style="text-align: center;">Priority</p> <p>32768 (0 - 61440, default 32768)</p> <p style="text-align: center;">Bridge Identifier</p> <p>32768-00:1D:AA:00:2B:0A</p> <p style="text-align: center;">Designated Root Bridge</p> <p>0-00:00:00:00:00:00</p> <p style="text-align: center;">Root Port</p> <p></p> <p style="text-align: center;">Root Path Cost</p> <p>0</p> <p style="text-align: center;">Remaining Hop</p> <p>0</p> <p style="text-align: center;"> <input type="button" value="OK"/> <input type="button" value="Cancel"/> </p> </div>
	VLAN - Enter the ID (1-4094) of the VLAN which should be

associated with this MSTI.

Priority - The switch priority for this MST instance. A lower number gives the switch higher chance to be chosen as the root bridge.

Bridge Identifier - Display the priority of MSTI instance number + MAC address of the switch.

Designated Root Bridge - Display the Bridge Identifier of the root bridge.

Root Port - Display the port toward the root.

Root Path Cost - Display the path cost toward the root.

Remaining Hop - Display the remaining hop count in BPDU.

OK - Save the modifications.

II-9-7 MST Port Setting

MST Port Settings is used to configure the GE port / LAG group settings for each MST instance. The table displays the MST parameters for each port.

Port	Path Cost	Priority	Port Role	Port State	Mode	Type	Designated B...	Designated P...	Designated C...	Remaining Hop
GE1	20000	128	Disabled	Disabled	RSTP	Boundary	0-00:00:00:00:00...	128-1	20000	20
GE2	20000	128	Disabled	Forwarding	RSTP	Boundary	0-00:00:00:00:00...	128-2	20000	20
GE3	20000	128	Disabled	Disabled	RSTP	Boundary	0-00:00:00:00:00...	128-3	20000	20
GE4	20000	128	Disabled	Forwarding	RSTP	Boundary	0-00:00:00:00:00...	128-4	20000	20
GE5	20000	128	Disabled	Disabled	RSTP	Boundary	0-00:00:00:00:00...	128-5	20000	20
GE6	20000	128	Disabled	Disabled	RSTP	Boundary	0-00:00:00:00:00...	128-6	20000	20
GE7	20000	128	Disabled	Disabled	RSTP	Boundary	0-00:00:00:00:00...	128-7	20000	20
GE8	20000	128	Disabled	Forwarding	RSTP	Boundary	0-00:00:00:00:00...	128-8	20000	20
GE9	20000	128	Disabled	Disabled	RSTP	Boundary	0-00:00:00:00:00...	128-9	20000	20
GE10	20000	128	Disabled	Forwarding	RSTP	Boundary	0-00:00:00:00:00...	128-10	20000	20
GE11	20000	128	Disabled	Disabled	RSTP	Boundary	0-00:00:00:00:00...	128-11	20000	20
GE12	20000	128	Disabled	Disabled	RSTP	Boundary	0-00:00:00:00:00...	128-12	20000	20

Available settings are explained as follows:

Item	Description
MSTI	Select one of the MST instances.
Edit	 - Click it to modify the path cost and priority setting for the port.

Edit Port GE1

MSTI

0

Path Cost

0 (1 - 200000000, 0 = Auto)

Priority

128

OK Cancel

MSTI - Display the selected MST instance.

Path Cost - Set path cost value for the port. A port with lowest value will be used as the forwarding port by spanning tree. Default value was set according to the bandwidth of the port.

Priority - Among the ports with same path cost, port with lower priority will have higher chance to be used as the forwarding port by spanning tree. Use the drop down list to choose desired priority value.

II-10 MAC Address Table

This section allows user to view the dynamic MAC address entries in the MAC table, change related setting, and assign MAC address into MAC table.

II-10-1 Static MAC Setting

This section allows user to manually assign MAC address into MAC table. The configuration result will be displayed on the table listed on the lower side of this web page.

The screenshot displays the 'Static MAC' configuration page. The top navigation bar includes 'Auto Logout: Off', 'Admin', 'P2121', and '11:28:44'. The breadcrumb trail is 'Switch LAN > MAC Address Table > Static MAC Setting > Static MAC'. The left sidebar lists various settings, with 'Static MAC Setting' highlighted. The main content area has a 'Static MAC' header and three input fields: 'MAC Address' (00:00:00:00:00:00), 'VLAN' (default), and 'Port' (GE1). A green 'Add' button is positioned below these fields. Below the form is a table with the following data:

No.	MAC Address	VLAN	Port	Delete
1	00:1D:AA:00:2B:0A	default(1)	CPU	

Available settings are explained as follows:

Item	Description
MAC Address	Enter the MAC address that will be forwarded.
VLAN	This is the VLAN group to which the MAC address belongs.
Port	Select the port where received frame of matched destination MAC address will be forwarded to.
Add	Click it to add any port into the static MAC table.
Delete	Click it to remove the selected port from the static MAC table.

II-10-2 Dynamic Address Setting

This page allows a user to configure aging time for dynamic MAC address.

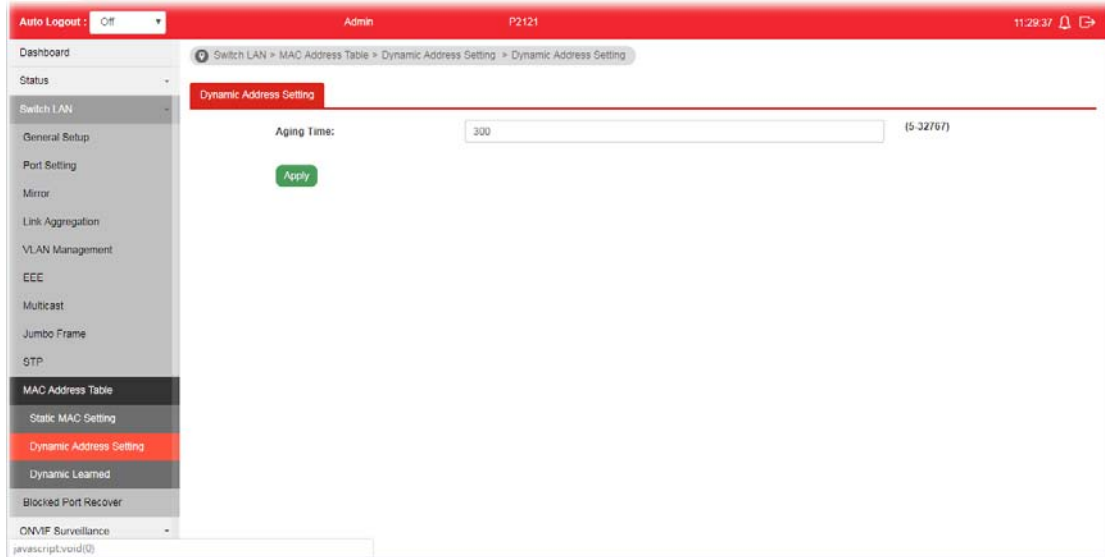

Available settings are explained as follows:

Item	Description
Aging Time	Enter the Dynamic MAC address aging out value (5-32767 seconds).
Apply	Apply the settings to the switch.

II-10-3 Dynamic Learned

This page displays the MAC address and port number automatically learned by VigorSwitch.

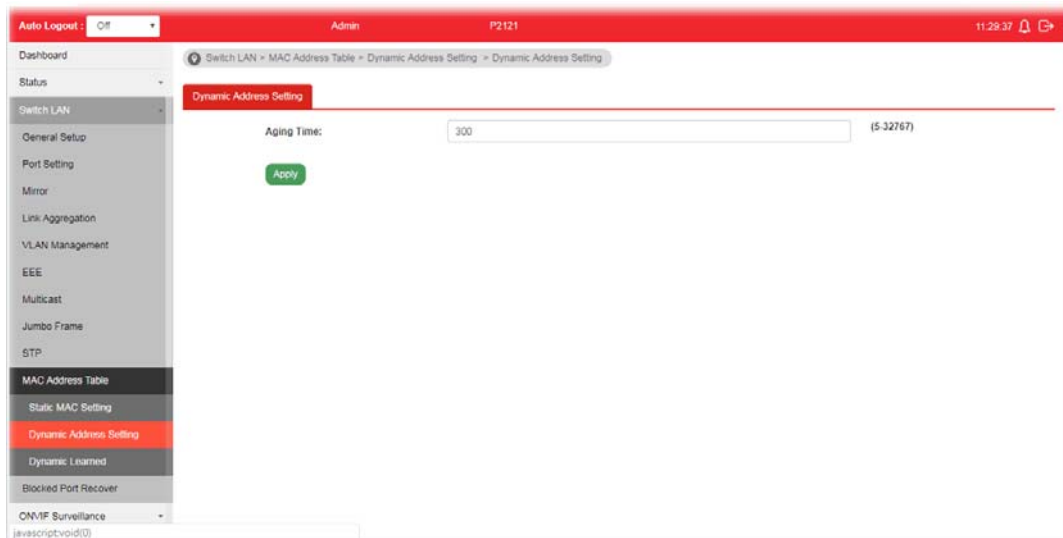

Available settings are explained as follows:

Item	Description
MAC Address	Display the MAC address that will be forwarded.

VLAN	Display the VLAN group to which the MAC address belongs.
Type	Display whether the MAC address is Dynamic (learned by the Switch) or Static Unicast (manually entered in the Static MAC Forwarding screen).
Port	Display the port to which this MAC address belongs.
Add to Static	Click this button to add any port into the static MAC table.

II-11 Blocked Port Recover

This page is used for configuring settings to recover the port which is being blocked by the following functions after a defined period of time.

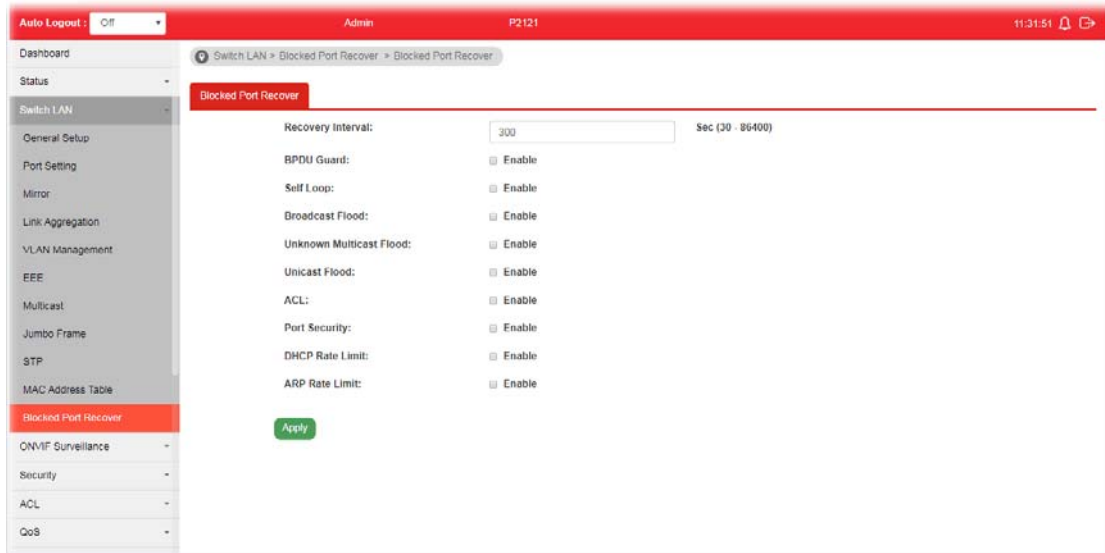

Available settings are explained as follows:

Item	Description
Recovery Interval	The port being blocked will be able to receive and send traffic after the time period configured here.
BPDU Guard	Enable - Recover the port being blocked by BPDU Guard after the time set in Recovery Interval.
Self Loop	Enable - Recover the port being blocked by self loop Guard after the time set in Recovery Interval.
Broadcast Flood	Enable - Recover the port being blocked by broadcast flood after the time set in Recovery Interval.
Unknown Multicast Flood	Enable - Recover the port being blocked by unknown multicast flood after the time set in Recovery Interval.
Unicast Flood	Enable - Recover the port being blocked by unicast flood after the time set in Recovery Interval.
ACL	Enable - Recover the port being blocked by ACL after the time set in Recovery Interval.
Port Security	Enable - Recover the port being blocked by port security after the time set in Recovery Interval.
DHCP Rate Limit	Enable - Recover the port being blocked by DHCP rate limit after the time set in Recovery Interval.
ARP Rate Limit	Enable - Recover the port being blocked by ARP rate limit after the time set in Recovery Interval.
Apply	Apply the settings to the switch.

Part III ONVIF Surveillance

III-1 Topology

ONVIF (Open Network Video Interface Forum), an International standard for current surveillance system industry, focuses on security products based on network IP address.

With this feature, VigorSwitch can:

- Integrate the ONVIF device and surveillance network
- Centralize management of IP video products
- View video images directly on VigorSwitch WUI
- Offer remote IP video products maintenance

ONVIF devices can be centralized and managed remotely via VigorSwitch. With a hierarchy view, the administrator can manage several ONVIF devices and check abnormal traffic detected by Vigor system.

III-1-1 Status

The status (including port enabled, traffic, downlink, etc.) of the IP cameras and NVRs (Network Video Recorders) can be seen on this page.

Available settings are explained as follows:

Item	Description
Discovery	<p>Enable - If enabled, VigorSwitch will automatically detect ONVIF devices, recognize third party IP cameras and NVR and integrate ONVIF device(s) to form surveillance network.</p> <p>Disable - Disable the function of Discovery.</p>
Default Username / Default Password	<p>Enter a name / password as the default value.</p> <p>In the entire ONVIF Surveillance menu, VigorSwitch will input this value in advanced and retrieve data. System administrator can access the IP device in which the username and password</p>

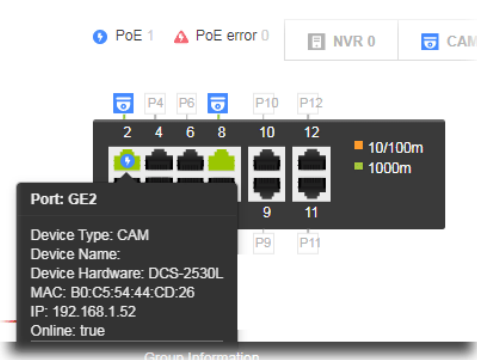
	<p>are as same as the default values.</p> <p>However, you can also input another username/password manually if the IP device username/password is different from the one you enter in Default Username/Default Password.</p>
Group	<p>Specify a group for displaying group information and device information under the selected group.</p> <p>Or, choose the default setting, All, to display information for all groups.</p>
PoE / PoE Error	<p>PoE - Display the number of LAN PoE device(s) connected to VigorSwitch.</p> <p>PoE Error - Display the number of LAN PoE device(s) disconnected.</p> 
NVR	<p>Display the number of NVR device(s) connected to VigorSwitch. The panel sketch on the screen will display which LAN port that the NVR device connected.</p>
CAM	<p>Display the number of IP camera(s) connected to VigorSwitch. The panel sketch on the screen will display which LAN port that the IP camera connected.</p>
Group Information	
Total Group	<p>Display the total number of groups.</p>
+Add New Group	<p>A group can contain one (IP camera or NVR, as group leader) to several devices (IP cameras as group devices).</p> <p>Click the button to create a new group for managing multiple devices.</p> <p>Step (1) - The first page allows you to configure general settings for a new group.</p>

- **Group Name** - Enter the name of a group.
- **Group by** - The system will detect the NVR or IP cameras, and list them on the field of NVR or Group Leader.
- **NVR/Group Leader** - Select an IP device. For the video from IP camera will be recorded on an NVR device, it is suggested to assign an NVR as the group leader.
- **Group Device** - This field lists all devices (IP cameras) not included by other group. Select one IP device to multiple devices or select all the devices for managed by this group.
- **ONVIF Device Admin Username/Password** - When the group members share the same username and password, enter the username and password in these two fields for administration.
- **Next** - Click it to access into next page.

Step (2) - The second page allows you to configure throughput threshold for the group port. It is helpful for the system administrator to make the corresponding process if encountered abnormal situation.

- **Apply to All Member Ports** - Check the box to apply the throughput threshold setting to all member ports.
- **GE# Ingress Threshold Mailalert** - Click **Enable** to set the ingress limit value. When the incoming traffic (packet) of the GE port reaches the limit, the Vigor System will send an alert email to the system administrator.
 - **GE# Ingress Rate** - If enabling the ingress threshold alert, enter the ingress rate as a threshold to send mail alert.
- **GE# Egress Threshold Mailalert** - Click **Enable** to set the egress limit value. When the outgoing traffic (packet) of the GE port reaches the limit, the Vigor System will send an alert email to the system administrator.
 - **GE# Egress Rate** - If enabling the egress threshold alert, enter the egress rate as a threshold to send mail alert.
- **OK** - Save the configuration and exit the box.
- **Cancel** - Exit the box without saving the configuration.

Device Information

Modify

Click it to modify the settings of the selected IP device.

✕

Edit Device - Camera

Online

Port

Device Name

Group

Auth Username

Auth Password

Location

Set Location

Settings may not take effect immediately

Reboot!

OK Cancel

III-2-2 Throughput Threshold

This page is used for set throughput threshold for **multiple** ONVIF devices managed by VigorSwitch.

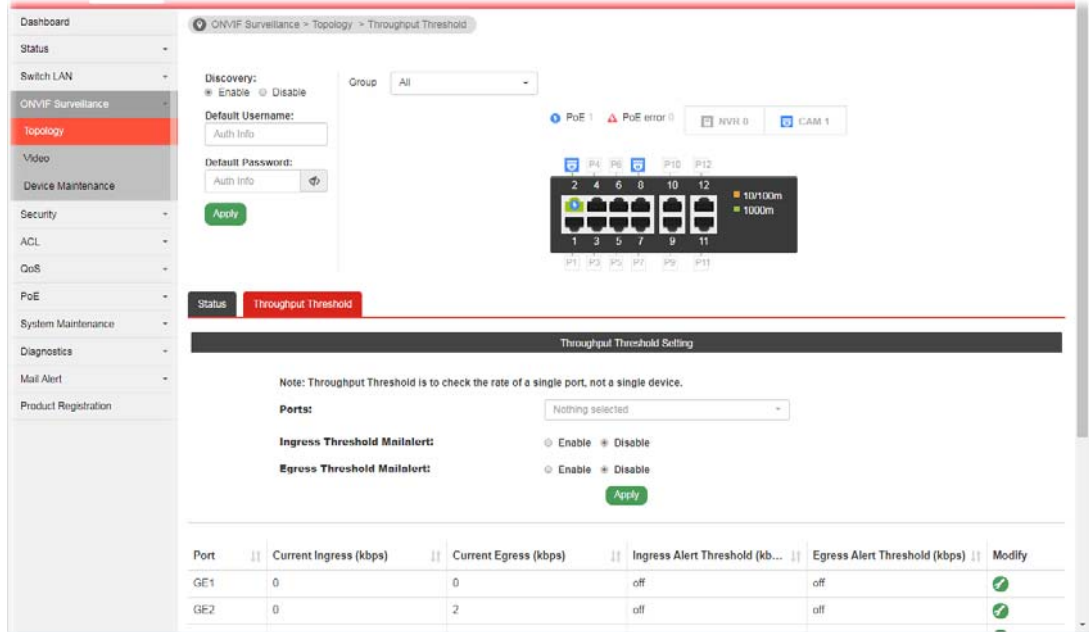

Available settings are explained as follows:

Item	Description
Ports	Specify one to several GE ports which will be limited by the threshold configured here.
Ingress Threshold Mailalert	<p>Disable - No mail alert will be sent out.</p> <p>Enable - When the ingress rate reaches the threshold configured here, Vigor system will send alert mail to specified mail address.</p> <ul style="list-style-type: none"> ● Ingress Rate (Kbps) - Enter a value as the threshold of ingress packets.
Egress Threshold Mailalert	<p>Disable - No mail alert will be sent out.</p> <p>Enable - When the egress rate reaches the threshold configured here, Vigor system will send alert mail to specified mail address.</p> <p>Egress Rate (Kbps)- Enter a value as the threshold of egress packets.</p>
Apply	Save the settings or changes to the switch.
Modify	Click it to modify the settings for the selected GE port / LAG port.

✕

Edit Port GE1

Ingress Threshold Alert

Enable Disable

Egress Threshold Alert

Enable Disable

Ingress Rate (Kbps)

16 (16-1000000, multiple of 16)

Egress Rate (Kbps)

16 (16-1000000, multiple of 16)

OK Cancel

III-2 Video

On this page, users may directly view images captured from the specified IP camera.

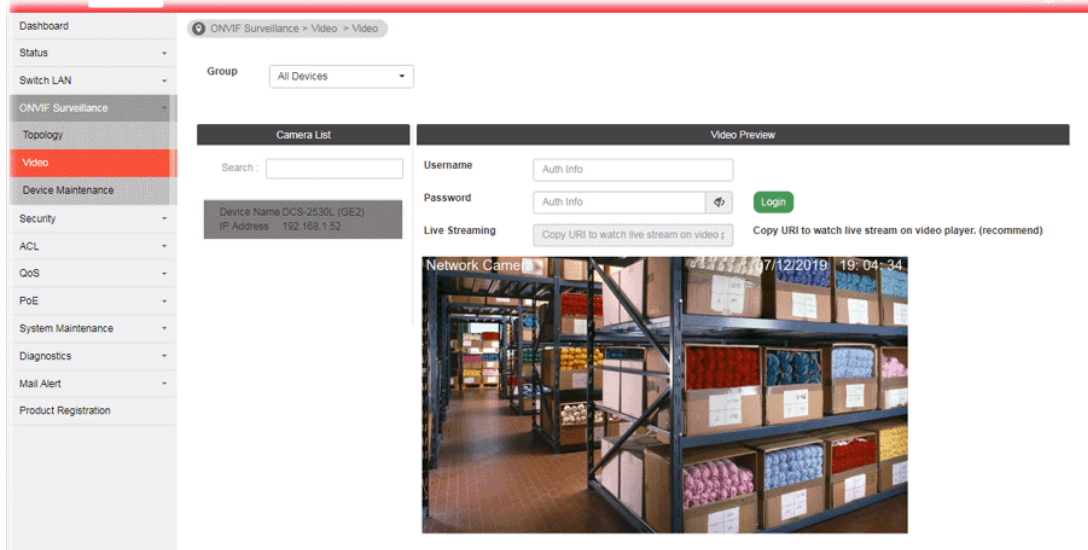

Available settings are explained as follows:

Item	Description
Group	Specify a group which contains the IP camera you want to check.
Camera List	Search - Enter the device name of the IP camera for searching and displaying on this field.
Video Preview	<p>After authenticated with correct username and password, the image of the specified IP camera (supported by VigorSwitch) will be shown immediately.</p> <p>Username / Password - The default username/password will be input if it is configured on the Topology page. However, if the default input is not the correct username/password, enter the correct one of the IP camera instead.</p> <p>Login - Click it to authenticate the username and password for the specified IP camera.</p> <p>Live Streaming - Display the streaming URI of the IP camera.</p>

III-3 Device Maintenance

The system administrator can remotely configure time setting and reboot the devices (IP camers or NVRs) managed by VigorSwitch.

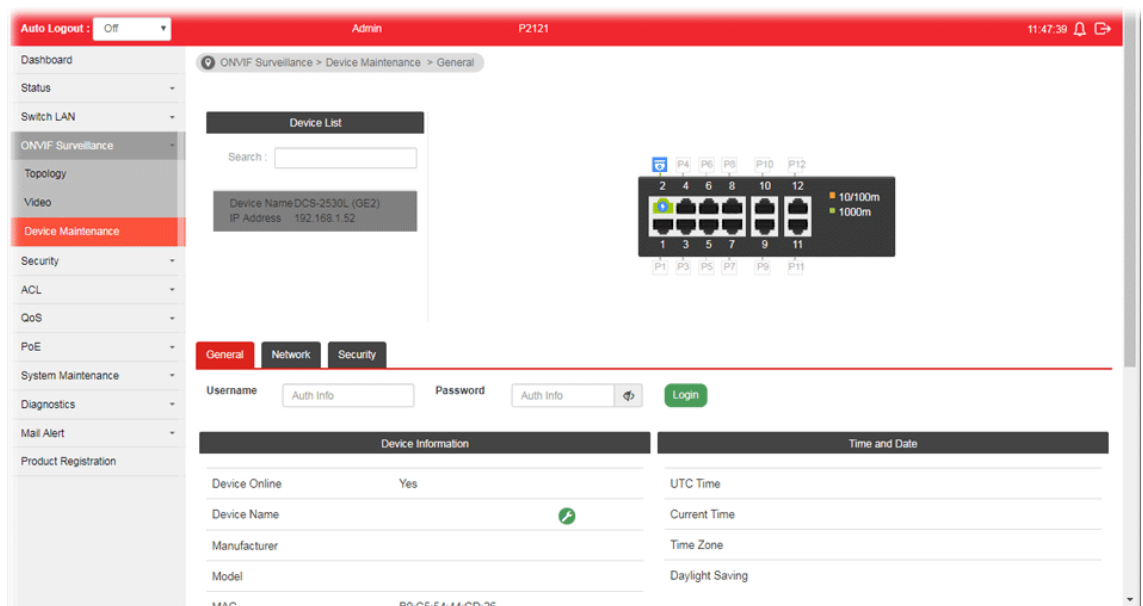

III-3-1 General

This page displays the information (e.g., device online, device name, etc.), time and date and the device action for a selected IP device (e.g., IP camera). Meanwhile, this page allows configuring settings for ping check of IP camera or NVR.

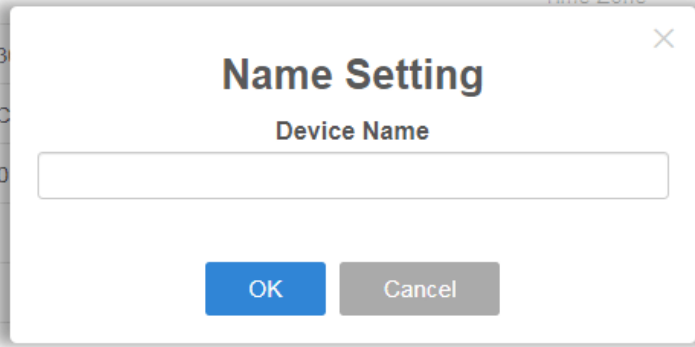

Available settings are explained as follows:

Item	Description
Device List	<p>Search - Enter a string to search the IP device you want.</p> <p>Username / Password - The default username/password will be input if it is configured on the Topology page. However, if the default input is not the correct username/password, enter the correct one of the IP device instead.</p> <p>Login - Click it to authenticate the username and password. Later, current network settings related to this device will be shown on the screen.</p>
Device Information	<p>Display the information related to the selected device.</p> <p> - Click it to modify the device name.</p>

	 <p>The image shows a 'Name Setting' dialog box with a title bar, a close button (X), a label 'Device Name', an empty text input field, and two buttons: 'OK' (blue) and 'Cancel' (grey).</p>
Time and Date	<p>Display the time and date information related to the selected device.</p> <p> - Click it to modify the time setting for the device.</p>
Device Action	<p>Display the action performed by IP-based device.</p> <p>Factory Default - Click the Apply button to rest the factory default to the IP device.</p> <p>Reboot - Click the Apply button to reboot the IP device immediately.</p>
Device Ping Check -- Configure settings for ping check of IP camera or NVR.	
Port	Display the port number of the IP device
Enable	<p>Enable - Click it to enable the device ping check function.</p> <p>Disable - Click it to disable the function.</p>
Ping IP Address	<p>Add Device - Click it to add an IP address of the device to be pinged by VigorSwitch. Up to 16 IP address(es) can be added and displayed in this field one by one (with the format of x.x.x.x, x.x.x.x, x.x.x.x...)</p> <p>Del Device - Click it to remove the selected IP address.</p>
Interval Time (sec)	Set a time interval (15, 30, 60, 120) for ping action.
Retry Time	Choose 1, 3, or 5 for Vigor system to retry the ping action.
Mail Alert	<p>Enable - When the device is offline, Vigor system will send an alert mail to notify the receiptant.</p> <ul style="list-style-type: none"> ● Mail with Snapshot - If enabled, the switch will try to get snapshot from the device per half hour. Before using this feature, set the group authentication information when adding group or configure Default Username/Password in the Topology page first. <p>Disable - When the device is offline, no action will be performed.</p>
Apply	Save the settings or changes to the switch.

III-3-2 Network

This page displays the network settings of the specified device (IP CAM or NVR).

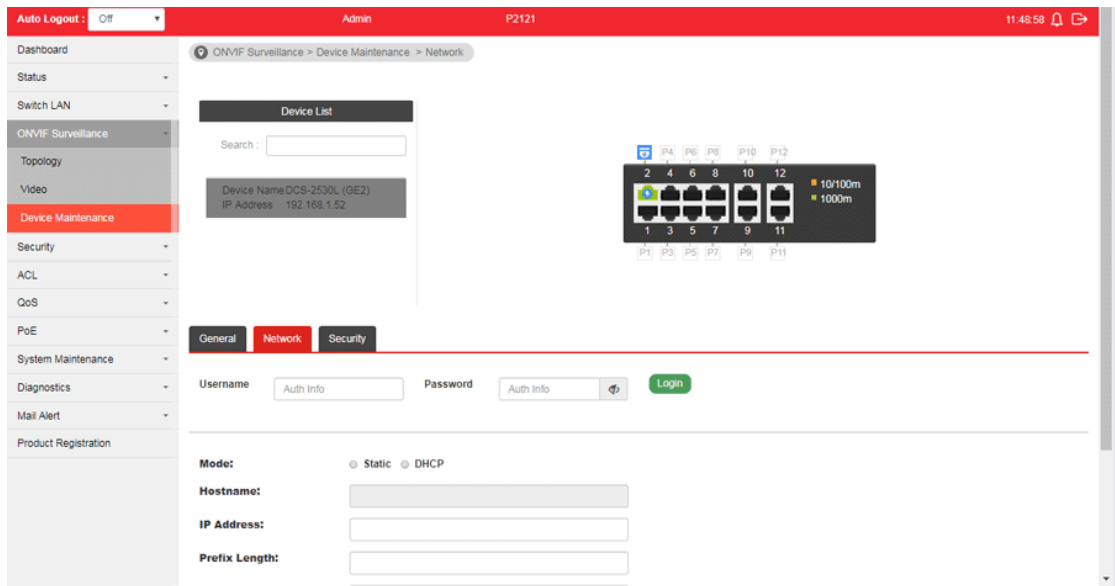

Available settings are explained as follows:

Item	Description
Device List	<p>Search - Enter a string to search the device you want.</p> <p>Username / Password - The default username/password will be input if it is configured on the Topology page. However, if the default input is not the correct username/password, enter the correct one of the IP device instead.</p> <p>Login - Click it to authenticate the username and password. Later, current network settings related to this device will be shown on the screen.</p>
Mode	<p>Change the connection mode for this device.</p> <p>Static - When it is selected, you have to enter value for network setting manually for the IP device.</p> <ul style="list-style-type: none"> ● IP Address - Enter an IPv4 address for the IP device. ● Prefix Length - Specify the subnet mask for the IP address. ● Gateway - Enter the IPv4 address for the gateway. ● DNS Server1/2 - Enter the IP address for primary / secondary DNS server. <p>DHCP - When it is selected, the IP device will be assigned with the settings by the network's DHCP server automatically to access the Internet.</p> <ul style="list-style-type: none"> ● Hostname - Display the hostname of the DHCP server.
Zero Configuration	<p>Enable - The network settings for the IP device will be configured automatically.</p> <p>Disable - The network settings for the IP device must be configured manually.</p>
Apply	Save the settings or changes to the switch.

III-3-3 Security

This page displays the security settings of the specified IP device (IP CAM or NVR).

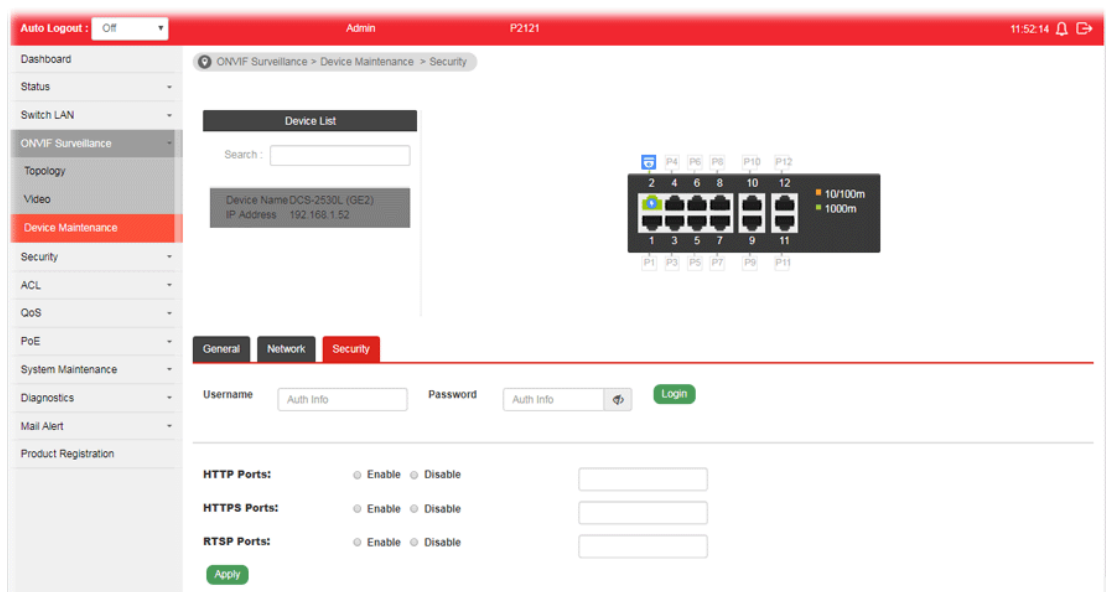

Available settings are explained as follows:

Item	Description
Device List	<p>Search - Enter a string to search the device you want.</p> <p>Username / Password - The default username/password will be input if it is configured on the Topology page. However, if the default input is not the correct username/password, enter the correct one of the IP device instead.</p> <p>Login - Click it to authenticate the username and password. Later, current network settings related to this device will be shown on the screen.</p>
HTTP Ports	<p>Current HTTP port number of the IP device is shown in this field.</p> <p>Enable - Click it to enable the HTTP port configuration and enter a port value if required.</p> <p>Disable - Disable the HTTP port configuration.</p>
HTTPS Ports	<p>Current HTTPS port number of the IP device is shown in this field.</p> <p>Enable - Click it to enable the HTTPS port configuration and enter a port value if required.</p> <p>Disable - Disable the HTTPS port configuration.</p>
RTSP Ports	<p>Current RTSP port number of the IP device is shown in this field.</p> <p>Enable - Click it to enable the RTSP port configuration and enter a port value if required.</p> <p>Disable - Disable the RTSP port configuration.</p>
Apply	Save the settings or changes to the switch.

This page is left blank.

Part IV Security

IV-1 RADIUS

This page allows the network administrator to add and configure multiple RADIUS servers.

Available settings are explained as follows:

Item	Description
Use Default Parameters	<p>Retries - The retry time before this server being considered not-reachable.</p> <p>Timeout for Reply - Set the time (in seconds) before this server being considered lost connection.</p> <p>Key String - Enter the string used to encrypt and authenticate with RADIUS server.</p> <p>Apply - Save the settings.</p>
Add RADIUS Server	<p>Address Type - Specify whether switch uses a hostname to resolve address by DNS to connect to server, or directly connect using IPv4 address.</p> <p>Sever Address - Enter the server's address corresponding with address type given.</p> <p>Server Port - Enter the port number used by RADIUS server.</p> <p>Accounting Port - Enter a port number to receive the information related to the user/device authenticated by the RADIUS server. The collected information will be used for network monitoring or statistics.</p> <p>Priority - Specify the priority that switch uses this server. The higher number, the lower priority. Switch will start with server with lowest priority.</p> <p>Retry - Set the time before this server being considered not-reachable</p> <p>Timeout - Set the time (in seconds) before this server being considered lost connection.</p> <p>Key String - Enter the key string used for encrypting and authenticating with server. Unless Key String is specified here, the default string will be used.</p> <p>Usage -Specify whether you would like to use this server for</p>

switch login authentication or 802.1x access port authentication, or both.

Add - Click it to add a new RADIUS server and display in this page.



under **Edit**- Click it to modify the priority setting for the selected GE port / LAG port.

Server: 192.168.1.56 ✕

Server Port: (1 - 65535, default 1812)

Priority: (0 - 65535)

Retry: Use Default
 sec (1 - 10, default 3)

Timeout: Use Default
 sec (1 - 30, default 3)

Key String: Use Default

Usage: Login 802.1x All

IV-2 TACACS+

This page allows the network administrator to add and configure multiple TACACS+ server.

Available settings are explained as follows:

Item	Description
Use Default Parameters	<p>Timeout -Set the time (in seconds) before this server being considered lost connection.</p> <p>Key String - Enter the string used to encrypt and authenticate with TACACS+ server.</p> <p>Apply - Save the settings.</p>
Add TACACS+ Server	<p>Address Type - Specify whether switch use a hostname to resolve address by DNS to connect to server, or directly connect using IPv4 address.</p> <p>Sever Address - Enter the server's address corresponding with address type given.</p> <p>Server Port - Enter the port number used by TACACS+ server.</p> <p>Priority - Specify the priority that switch uses this server. The higher number, the lower priority. Switch will start with server with lowest priority.</p> <p>Timeout -Set the time (in seconds) before this server being considered lost connection.</p> <p>Key String - Enter the key string used for encrypting and authenticating with server. Unless Key String is specified here, the default string will be used.</p> <p>Add - Click it to add a new RADIUS server and display in this page.</p> <p> under Edit- Click it to modify the priority setting for the selected GE port / LAG port.</p>

IV-3 Management Access Authentication

IV-3-1 Method Profile

This page allows a user to create method list for applying on management service.

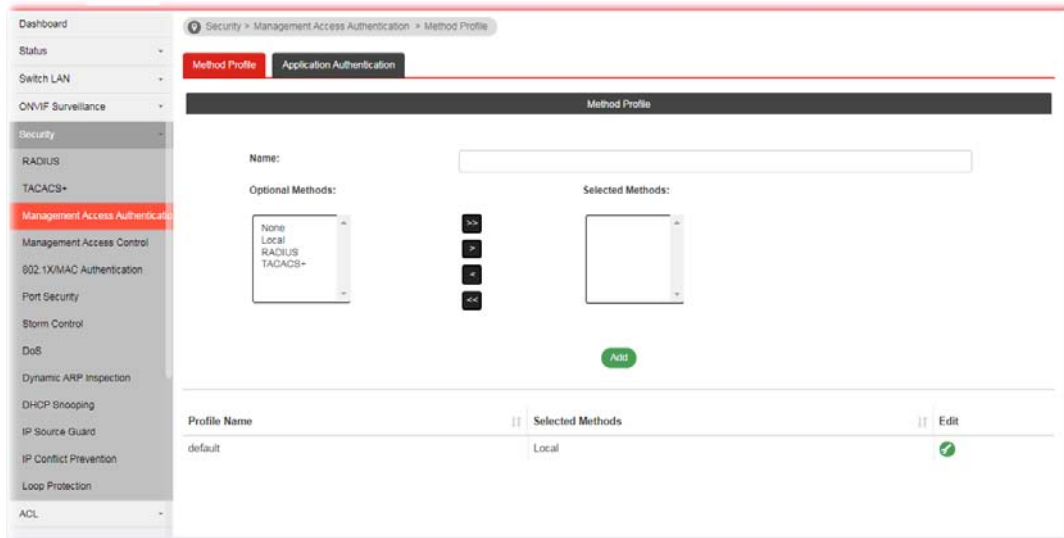

Available settings are explained as follows:

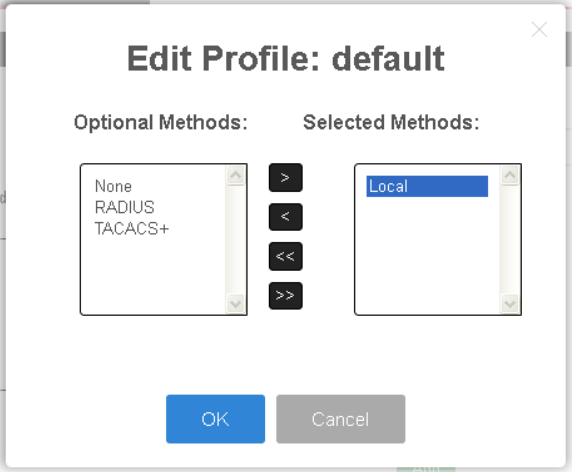
Item	Description
Method Profile	<p>Name - Enter a name for creating a method.</p> <p>Optional Methods - Available methods include Local, RADIUS and TACACS+.</p> <p>Selected Methods - The method listed in this field will be applied for such method profile.</p> <p>Add - Click it to add a method from Optional Method onto Selected Method.</p>
 under Edit	<p>Click it to modify the optional methods/selected methods for the selected profile.</p> 

IV-3-2 Application Authentication

This page allows the network administrator to select the customized Method List to apply to any management service, for management access control.

Application	Selected Profile
Console	default
Telnet	default
SSH	default
HTTP	default
HTTPS	default

Available settings are explained as follows:

Item	Description
Application	There are five methods to be configured with different profile respectively. <ul style="list-style-type: none"> ● Console/Telnet/SSH/HTTP/HTTPS
Selected Profile	Specify one of customized method profiles to apply to any management service, for management access control.
Apply	Save the settings.

IV-4 Management Access Control

IV-4-1 Management Access Control Profile (ACL)

This page allows a user to add, edit, and delete Management Access Control profiles.

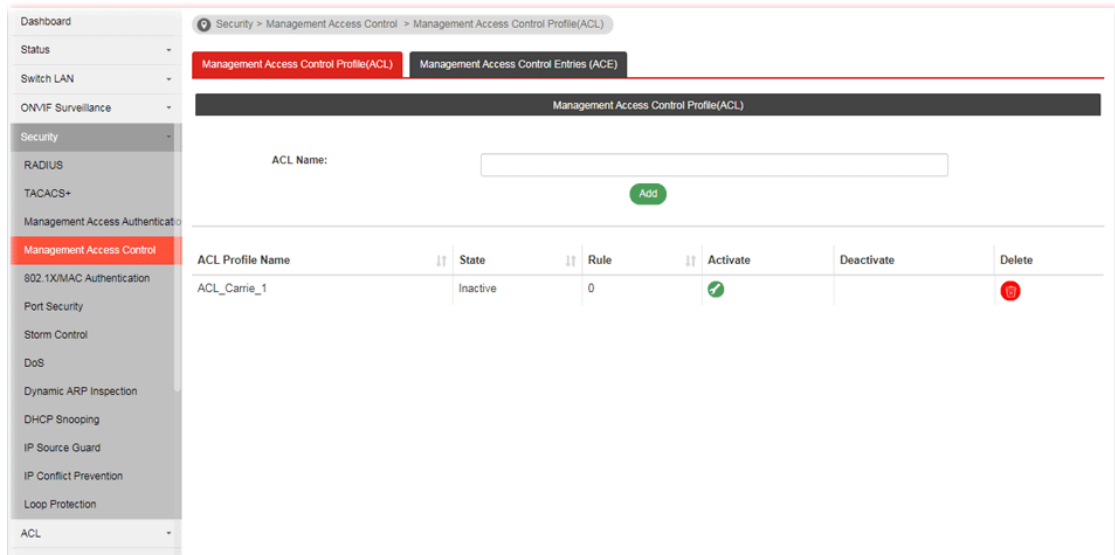

Available settings are explained as follows:

Item	Description
ACL Name	Enter a name to create a profile for ACL. Once a profile is created, it will be displayed on this page.
Add	Click it to create a new ACL profile after entering the ACL name.
ACL Profile Name	Display the name of the ACL profile.
State	Display if such ACL profile is active or inactive.
Rule	Display the number of ACE used by this ACL profile.
Activate / Deactivate	 - Click it to activate / deactivate such entry. To configure detailed settings for the selected ACL profile, do not click Activate for that profile.
Delete	Click the icon under Delete to remove the selected entry.

IV-4-2 Management Access Control Entries (ACE)

This page allows a user to add, edit, or remove Access Control Entries (ACE) of the Management Access Control profiles. However, only the ACE of inactive profiles can be modified, and before configuring ACE, at least one ACL profile should be created.

Available settings are explained as follows:

Item	Description
ACL Profile Name	Use the drop-down list to select the inactive ACL profile you would like to modify.
Priority	Specify a priority number (1 to 65535) for such rule. The lower the number, the higher the priority.
Service	Choose the service type you would like to control the access.
Action	Select the action to be taken on the traffic of selected service type. Deny - Incoming / outgoing data which meets ACE rules will be blocked. Permit - Incoming / outgoing data which meets ACE rule is allowed to pass through.
Ports	Select the ports to which the ACL should be applied.
IP Versions	Specify the IP address/subnet to which the ACL should be applied. <ul style="list-style-type: none"> ● All - All the IP address should be applied. ● IPv4 - Specify the IPv4 address /subnet. ● IPv6 -Specify the IPv6 address /subnet.
IPv4	Enter the IPv4 address/subnet to which the ACE rule should apply.
IPv6	Enter the IPv6 address/subnet to which the ACE rule should apply.
Add	Click it to create an ACE rule profile. Then, such ACE rule profile will be shown on the table below.

Edit



- click it to modify the settings for the selected entry.

✕

Edit ACE with ACL profile=sdf and Priority=1

Service:

Action:

Ports:

IP Versions: All IPv4 IPv6

IPv4: /

IPv6: /



- click it to remove the selected entry.

IV-5 802.1X/MAC Authentication

The authentication manager allows you to configure securely access from any host connected to physical ports. You may apply multiple ways of authentication to each port.

IV-5-1 Properties

IV-5-1-1 Global Settings

VigorSwitch P2121 supports 802.1x and MAC-based authentication methods. In Global Settings page, you can specify authentication type, enable Guest VLAN function, specify a VID and select format for MAC address entry.

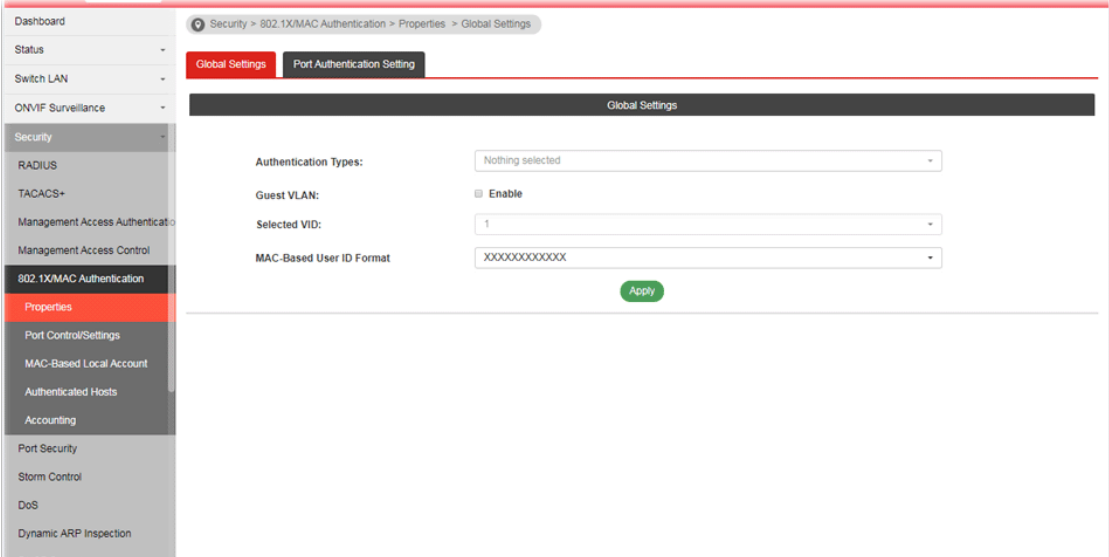

Available settings are explained as follows:

Item	Description
Global Settings	<p>Authentication Types - Use the drop down list to specify which type (802.1x, MAC-based) will be used for authentication. Choose to enable 802.1x or MAC-based authenticate method for host connecting to Ethernet port. You may configure which type to be used per port, but enabling any per port without enabling here will not be effective.</p> <p>Guest VLAN - Check to enable a Guest VLAN for those have not successfully authenticated with any given methods. Choose one of the VLAN ID as a Guest VLAN.</p> <p>Selected VID - If Guest VLAN is enabled, use the drop down list to specify one VID number.</p> <p>MAC-Based User ID Format -Specify how the MAC-based user ID should be expressed in EAP message between AAA server and switch.</p> <p>Apply - Click it to save the settings.</p>
Apply	Save and activate the settings configured above.

IV-5-1-2 Port Authentication Setting

This page allows the network administrator to configure detailed authentication settings for each port.

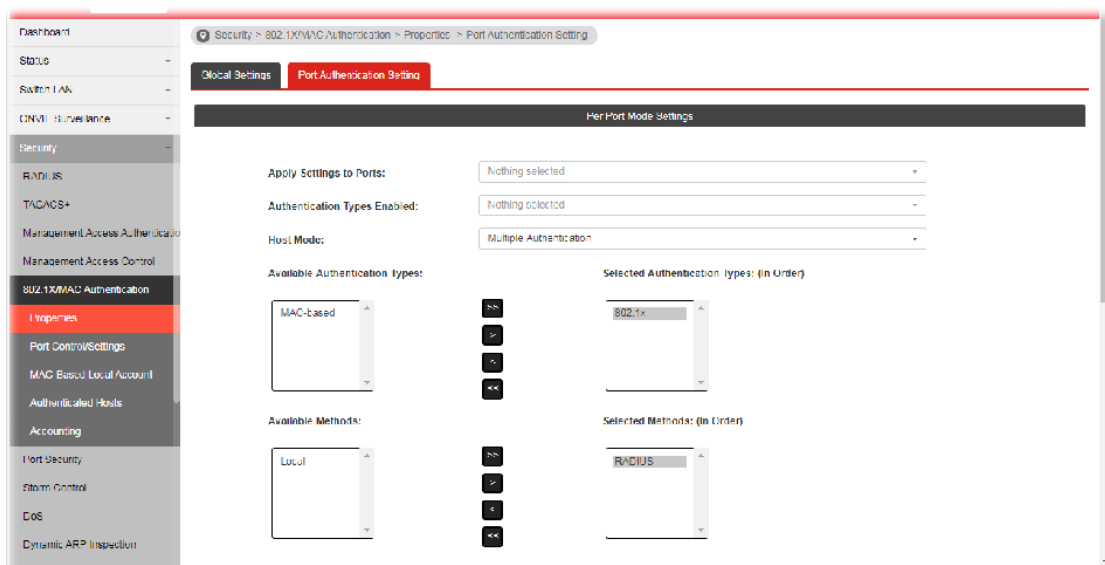

Available settings are explained as follows:

Item	Description
Apply Settings to Ports	Select physical port(s) for applying settings. Note that port authentication will not be effective if none of them were enabled.
Authentication Types Enabled	Select 802.1x and/or MAC-based authenticate method for host connecting to this port.
Host Mode	Multiple Authentication - Each host are authenticated individually. Multiple Hosts - Authentication is done on port basis, only one authenticated host is required; other hosts connected to this port can access freely as authenticated host. Single Host - Only one host can be authenticated, and access the port.
Available Authentication Types	Display available authentication types of AAA server (or local) you wish to have on this port.
Selected Authentication Types	Specify the order of authentication type you wish to have on this port.
Available Methods	Display available methods of AAA server (or local) you wish to have on this port.
Selected Methods	Specify the order of authentication methods you wish to have on this port.
Guest VLAN	Check Enable to enable Guest VLAN on this port for those didn't authenticated successfully.
RADIUS VLAN Assignment	Disable - Switch will ignore the VLAN assignment from the RADIUS server and keep the original VLAN of the host. Static - Switch will use the VLAN assignment from the RADIUS server if it receives the information. If there is not VLAN information, it will keep the original VLAN of the host. Reject - Switch will reject the host if it does not receive the

	VLAN information from RADIUS server.
Apply	The modification made above can be applied on to the selected GE port immediately.

IV-5-2 Port Control/Settings

This page allows the network administrator to controls port setting, based on 802.1X, for ethernet port authentication.

The screenshot displays the 'Port Control/Settings' configuration page. The left sidebar shows the navigation menu with 'Port Control/Settings' selected. The main content area contains the following settings:

- Ports:** Nothing selected
- Port Control:** Disabled
- Periodic Reauthentication:** Enable
- Max Hosts:** 256 (1-256, default 256)
- Reauthentication Period:** 3600 (Sec (300 - 4294967294, default 3600))
- Inactive Timeout:** 60 (Sec (60 - 65535, default 60))
- Quiet Period:** 60 (Sec (60 - 65535, default 60))
- Resend EAP Period(802.1X Parameter):** 30 (Sec (30 - 65535, default 30))
- Supplicant Timeout(802.1X Parameter):** 30 (Sec (30 - 65535, default 30))
- Server Timeout(802.1X Parameter):** 30 (Sec (30 - 65535, default 30))
- Max EAP Requests(802.1X Parameter):** 2 (1 - 10, default 2)

An 'Apply' button is located at the bottom right of the settings area.

Available settings are explained as follows:

Item	Description
Ports	Select the ports to modify the port control settings.
Port Control	Specify if you wish this account to be allowed (Authorized) or blocked (Unauthorized) or determined by VigorSwitch (Auto). <ul style="list-style-type: none"> ● Disabled - Disable any authentication requirement for port access. All clients are allowed to access the network. ● Force Authorized- Port will be considered authorized. All clients are allowed to access the network. ● Force Unauthorized - Port will be considered un-authorized. All clients are NOT allowed to access the network. ● Auto - Port will be considered authorized or unauthorized based on the authentication results of the host.
Periodic Reauthentication	Enable - The hosts via the selected GE port will be re-authenticated periodically.
Max Hosts	If Multiple Authentication mode is selected as Host Mode (802.1X/MAC Authentication>>Properties>>Port Authentication Setting), the total number of hosts cannot exceed the maximum number of hosts configured here.
Reauthentication Period	Enter a time period. When the time is up, the host shall return to initial state and prepare to pass authentication procedure

	again. Default is 3600 seconds.
Inactivate Timeout	When there is no packet coming from the authenticated host, the system will start the inactive timer. After inactive timeout, the host will be unauthorized and corresponding session will be deleted. In Multiple Hosts mode (configured in 802.1X/MAC Authentication>>Properties>>Port Authentication Setting), the packet is counted on the authorized host only and not all packets on the port.
Quiet Period	When a GE port is disabled just because authentication fails several times, the host connected to that port will be blocked for a period of time configured in quiet period. Later, after the time period set in this field, the host will be allowed to perform authentication again.
Resend EAP Period (802.1X Parameter)	Set the period for host to re-send EAP (Ethernet Automatic Protection) requests. Default value is 30 (seconds).
Supplicant Timeout(802.1X Parameter)	Set a period of time for the maximum number of EAP requests will be sent. If a response from the host is not received by VigorSwitch after the defined period (supplicant timeout), the authentication process will be started again.
Server Timeout (802.1X Parameter)	Set a period of time for the server. The EAP requests shall be resent to the supplicant within the time; otherwise, the time setting will lapse and the requests won't be sent out.
MAX EAP Request (802.1X Parameter)	Set the maximum time interval for EAP request sent out.
Apply	The modification made above can be applied on to the selected GE port immediately.

IV-5-3 MAC-Based Local Account

This page allows the network administrator to create profiles by entering MAC address of the hosts to be authenticated.

The screenshot displays the 'MAC-Based Local Account Settings' configuration page. On the left is a navigation menu with 'MAC-Based Local Account' selected. The main area contains the following settings:

- MAC Address:** Input field with value '00:00:00:00:00:00'.
- Port Control:** Radio buttons for 'Force Authorized' (selected) and 'Force Unauthorized'.
- VLAN:** Radio buttons for 'User Defined' (selected) and a dropdown menu showing '1' (range 1-4094).
- Reauthentication Period:** Radio buttons for 'User Defined' (selected) and a dropdown menu showing '3600' (range Sec (300 - 4294967294)).
- Inactive Timeout:** Radio buttons for 'User Defined' (selected) and a dropdown menu showing '60' (range Sec (60 - 65535)).

Below the settings is a table with the following columns: MAC Address, Port Control, VLAN, Reauthentication Period, Inactive Timeout, and Edit. The table is currently empty, displaying 'No data available in table'.

Available settings are explained as follows:

Item	Description
MAC Address	Enter the MAC address of the host.
Port Control	Specify a control type for the host. <ul style="list-style-type: none"> ● Force Authorized - Click it to forcefully authenticate the host specified above. ● Force Unauthorized - The host specified above will not be authenticated by VigorSwitch.
VLAN	User Defined - Check it to specify which VLAN will be assigned by the host of this account.
Reauthentication Period	User Defined - Check it to specify the time this account required to be authenticated again after authentication taken place.
Inactive Timeout	User Defined - Check it to specify the time of inactive this account becoming log-off.
Add	Click it to create a new account.
Edit	It is available when there is one profile existed. <ul style="list-style-type: none">  - Click it to modify the settings for the selected entry.

IV-5-4 Authenticated Hosts

This page displays information related to the host authenticated by VigorSwitch.

Dashboard

Security > 802.1X/MAC Authentication > Authenticated Hosts > Authenticated Hosts

Authenticated Hosts

Session ID	Port	MAC Address	Current Type	Status	Operational V...	Operational S...	Operational I...	Operational ...	Authorized V...
No data available in table									

IV-5-5 Accounting

This page allows the network administrator to authenticate the client via RADIUS server.

After enabling the accounting service, VigorSwitch will periodically transmit information related to the authenticated user or device to the RADIUS server to comprehend the usage records of the user/device for the purposes of network monitoring or billed accordingly.

At present, VigorSwitch supports and sends the following attributes to specified RADIUS server.

- NAS-IP-Address
- Called-Station-Id
- NAS-Identifier
- NAS-Port-Type
- User-Name
- Acct-Session-Id
- Acct-Status-Type
- Acct-Input-Octets
- Acct-Output-Octets
- Acct-Input-Gigawords
- Acct-Output-Gigawords

The screenshot shows the 'Accounting' configuration page in the VigorSwitch web interface. The left sidebar contains a navigation menu with 'Accounting' highlighted. The main content area shows the following settings:

- State:** Enable Disable
- Server:** RADIUS
- Disconnect Message Port:** (1 - 65535, default 3799)
- Update Period:** Min(1 - 60)

An 'Apply' button is located at the bottom right of the configuration area.

Available settings are explained as follows:

Item	Description
State	Enable - Enable the authentication made by the RADIUS server. Disable - Disable the function.
Server	RADIUS - At present, only RADIUS server can be used for authentication.
Disconnect Message Port	Enter a port number (1~65535) to notify the system administration the disconnection of RADIUS server.
Update Period	Enter the update period (1~60) for authentication.

IV-6 Port Security

This page allows the network administrator to configure security settings for each port interface (GE port /LAG group). When port security is enabled for each interface, related action will be performed once detecting that the number of MAC address exceeds the limit.

The screenshot shows the 'Port Security' configuration page. The left sidebar contains a navigation menu with 'Port Security' highlighted. The main content area has the following configuration options:

- State:** Enable Disable
- Ports:** Nothing selected
- Port State:** Enable Disable
- MAC Address:** 1 (0 - 255)
- Action:** Forward Discard Shutdown

Below the configuration options is a table with the following data:

Port	State	MAC Address	Action	Modify
GE1	Disabled	1	Discard	
GE2	Disabled	1	Discard	
GE3	Disabled	1	Discard	
GE4	Disabled	1	Discard	
GE5	Disabled	1	Discard	
GE6	Disabled	1	Discard	

Available settings are explained as follows:

Item	Description
State	Enable or disable port security function on the switch. Enabled - Enable the port security function. Disabled - Disable the port security function.
Ports	Select the port(s) you would like to configure the port security settings.
Port State	Enable or disable port security function on the ports selected above. Enabled - The selected port applies the port security settings. Disabled - The selected port does not apply the port security settings.
MAC Address	Enter the maximum number of MAC addresses that the port is allowed to learn.
Action	Select an action to perform when there is an unknown MAC address on the port. Forward - Forward a packet whose source MAC is unknown to the switch. Discard - Discard a packet whose source MAC is unknown to the switch. Shutdown - Shutdown this port when a packet with unknown source MAC is received.
Apply	The modification made above can be applied on to the selected GE/LAG port immediately.
Modify	 - click it to modify the settings for the selected entry.

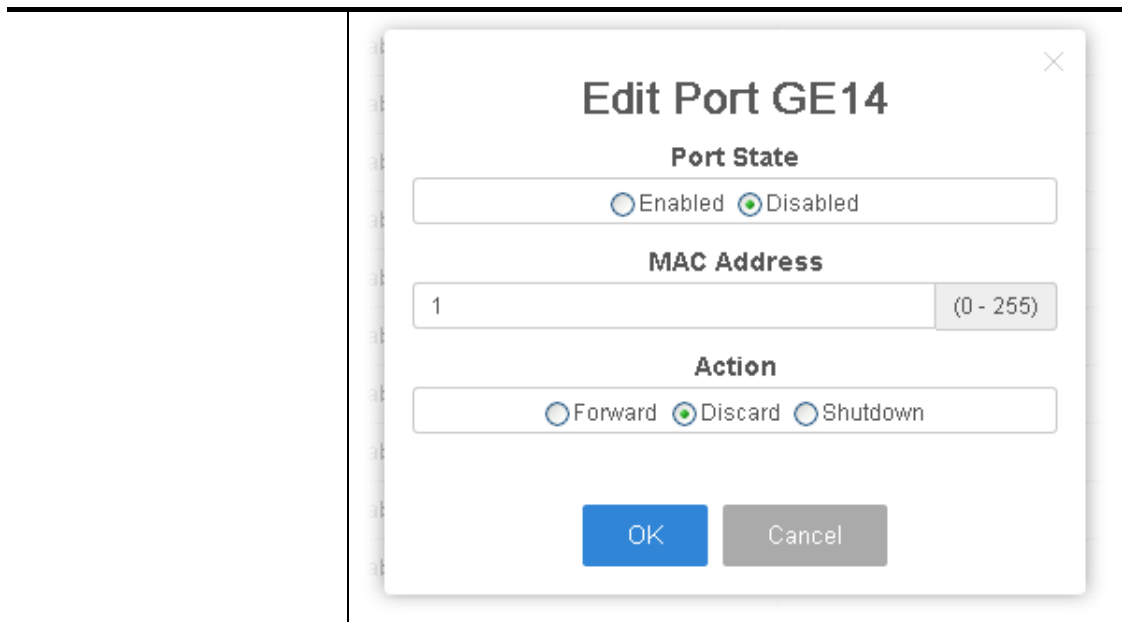

IV-7 Storm Control

Storm Control helps to suppress possible broadcast, unknown multicast or unknown unicast storm by applying a rate limit on those packets.

IV-7-1 Properties

This page allows a user to configure general settings for Storm Control.

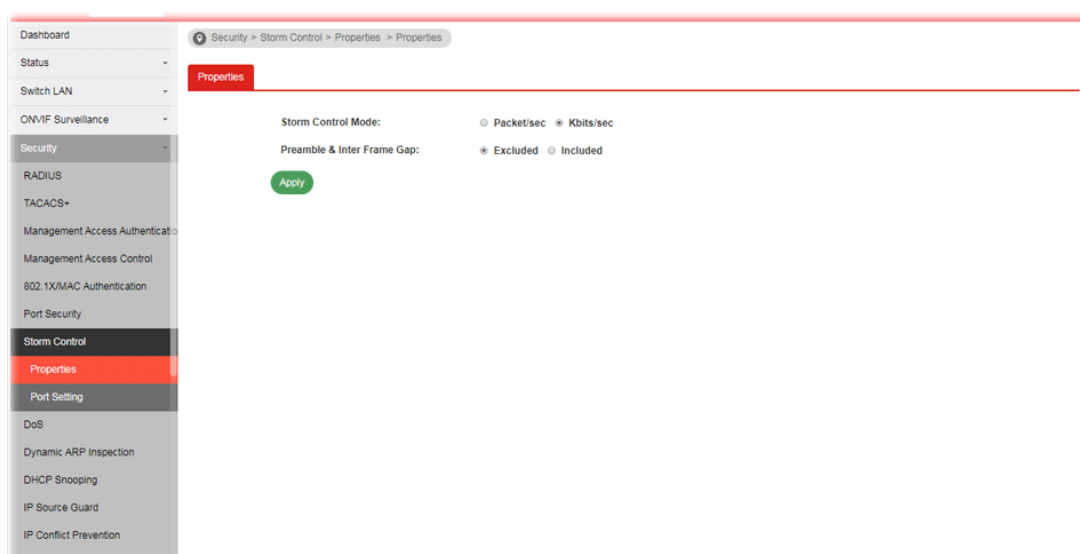

Available settings are explained as follows:

Item	Description
Storm Control Mode	Select the mode of storm control. Packet/sec - Storm control rate will be calculated by packet-based. Kbits/sec - Storm control rate will be calculated by octet-based.
Preamble & Inter Frame Gap	Select the rate calculation with/without preamble & IFG (20 bytes). Excluded - Exclude preamble & IFG (20 bytes) when count ingress storm control rate. Included - Include preamble & IFG (20 bytes) when count ingress storm control rate.
Apply	Apply the settings to the switch.

IV-7-2 Port Setting

This page allows the network administrator to configure port settings for Storm Control. The configuration result for each port will be displayed on the table listed on the lower side of this web page.

Port	Storm Control	Broadcast (Kbps)	Unknow Multicast (Kbps)	Unknow Unicast (Kbps)	Action	Modify
GE1	Disabled	Disabled	Disabled	Disabled	Drop	✓
GE2	Disabled	Disabled	Disabled	Disabled	Drop	✓
GE3	Disabled	Disabled	Disabled	Disabled	Drop	✓
GE4	Disabled	Disabled	Disabled	Disabled	Drop	✓

Available settings are explained as follows:

Item	Description
Ports	Use the drop down list to select the port profile (GE1 to GE12).
Storm Control	Disable - Disable the storm control configuration for the selected port profile. Enable - Enable the storm control configuration for the selected port profile.
Limiting Rate	Check the box(es) to enable storm control rate limited for Broadcast, Unknown Multicast and/or Unknow Unicast packet. Broadcast - Specify the storm control rate for Broadcast packet. Value of storm control rate, Unit: Kbps (Kbits per-second). The range is from 16 to 1000000. Unknown Multicast - Specify the storm control rate for unknown multicast packet. Value of storm control rate, Unit: Kbps (Kbits per-second). The range is from 16 to 1000000. Unknown Unicast - Specify the storm control rate for unknown multicast packet. Value of storm control rate, Unit: Kbps (Kbits per-second). The range is from 16 to 1000000.
Action	Select the state of setting. Drop - Packets exceed storm control rate will be dropped. Shutdown - Port exceeds storm control rate will be shutdown.
Apply	Apply the settings to the switch.

IV-8 DoS

A Denial of Service (DoS) attack is a hacker attempt to make a device unavailable to its users. DoS attacks saturate the device with external communication requests, so that it cannot respond to legitimate traffic. These attacks usually lead to a device CPU overload.

The DoS protection feature is a set of predefined rules that protect the network from malicious attacks. The DoS Security Suite Setting enables activating the security suite.

IV-8-1 Properties

This page allows a user to configure DoS setting to enable/disable DoS function for global setting.

Setting	Enable/Disable	Value/Unit
Dst MAC = Src MAC	<input type="radio"/> Enable <input checked="" type="radio"/> Disabled	
LAND	<input type="radio"/> Enable <input checked="" type="radio"/> Disabled	
UDP Blat	<input type="radio"/> Enable <input checked="" type="radio"/> Disabled	
TCP Blat	<input type="radio"/> Enable <input checked="" type="radio"/> Disabled	
Ping of Death	<input type="radio"/> Enable <input checked="" type="radio"/> Disabled	
IPv6 Min Fragments	<input type="radio"/> Enable <input checked="" type="radio"/> Disabled	1240 Bytes (0-65535)
ICMP Fragments	<input type="radio"/> Enable <input checked="" type="radio"/> Disabled	
IPv4 Ping Max Size	<input type="radio"/> Enable <input checked="" type="radio"/> Disabled	
IPv6 Ping Max Size	<input type="radio"/> Enable <input checked="" type="radio"/> Disabled	
Ping Max Size Setting	<input type="radio"/> Enable <input checked="" type="radio"/> Disabled	512 Bytes (0-65535)
Smurf Attack	<input type="radio"/> Enable <input checked="" type="radio"/> Disabled	Netmask Length: 0 (0-32)
TCP Min Hdr Size	<input type="radio"/> Enable <input checked="" type="radio"/> Disabled	20 Bytes (0-31)
TCP-SYN (SPORT<1024)	<input type="radio"/> Enable <input checked="" type="radio"/> Disabled	
Null Scan Attack	<input type="radio"/> Enable <input checked="" type="radio"/> Disabled	

Available settings are explained as follows:

Item	Description
Dst MAC=Src MAC	Drop the packets if the destination MAC address is equal to the source MAC address. Disabled - Disable the item function. Enabled - Enable the item function.
LAND	Drop the packets if the source IP address is equal to the destination IP address. Disabled - Disable the item function. Enabled - Enable the item function.
UDP Blat	Drop the packets if the UDP source port equals to the UDP destination port. Disabled - Disable the item function. Enabled - Enable the item function.
TCP Blat	Drop the packages if the TCP source port is equal to the TCP destination port. Disabled - Disable the item function. Enabled - Enable the item function.

Ping of Death	Avoid ping of death attack. Ping packets that length are larger than 65535 bytes. Disabled - Disable the item function. Enabled - Enable the item function.
IPv6 Min Fragments	Check the minimum size of IPv6 fragments, and drop the packets smaller than the minimum size. The valid range is from 0 to 65535 bytes, and default value is 1240 bytes. Disabled - Disable the item function. Enabled - Enable the item function.
ICMP Fragments	Drop the fragmented ICMP packets. Disabled - Disable the item function. Enabled - Enable the item function.
IPv4 Ping Max Size	Determine the IPv4 PING packet with the length. Disabled - Disable the item function. Enabled - Enable the item function. -
IPv6 Ping Max Size	Determine the IPv6 PING packet with the length. Disabled - Disable the item function. Enabled - Enable the item function.
Ping Max Size Setting	Determine the IPv4/IPv6 PING packet with the length. Specify the maximum size of the ICMPv4/ICMPv6 ping packets. The valid range is from 0 to 65535 bytes, and the default value is 512 bytes.
Smurf Attack	Avoid smurf attack. The length range of the netmask is from 0 to 323 bytes, and default length is 0 byte. Disabled - Disable the item function. Enabled - Enable the item function.
TCP Min Hdr Size	Check the minimum TCP header and drops the TCP packets with the header smaller than the minimum size. The length range is from 0 to 31 bytes, and default length is 20 bytes. Disabled - Disable the item function. Enabled - Enable the item function.
TCP-SYN (SPORT<1024)	Drop SYN packets with sport less than 1024. Disabled - Disable the item function. Enabled - Enable the item function.
Null Scan Attack	Drop the packets with NULL scan. Disabled - Disable the item function. Enabled - Enable the item function.
X-mas Scan Attack	Drop the packets if the sequence number is zero, and the FIN, URG and PSH bits are set. Disabled - Disable the item function. Enabled - Enable the item function.
TCP SYN-FIN Attack	Drop the packets with SYN and FIN bits set. Disabled - Disable the item function. Enabled - Enable the item function. -
TCP SYN-RST Attack	Drop the packets with SYN and RST bits set. Disabled - Disable the item function. Enabled - Enable the item function.

TCP Fragment (Offset=1)	Drop the fragmented ICMP packets. Disabled - Disable the item function. Enabled - Enable the item function.
Apply	Apply the settings to the switch.

IV-8-2 DoS Port Setting

This page allows a user to configure and display the state of DoS protection for interfaces. The configuration result for each port will be displayed on the table listed on the lower side of this web page.

The screenshot shows the 'DoS Port Setting' configuration page. The left sidebar has 'DoS' selected, with 'DoS Port Setting' highlighted. The main content area includes a breadcrumb 'Security > DoS > DoS Port Setting > Port Settings', a 'Port Settings' header, a 'Ports:' dropdown menu (currently 'Nothing selected'), and 'DoS Protection' radio buttons for 'Enable' and 'Disable' (with 'Disable' selected). An 'Apply' button is visible. Below is a table with columns 'Port', 'DoS Protection', and 'Modify'.

Port	DoS Protection	Modify
GE1	Disabled	
GE2	Disabled	
GE3	Disabled	
GE4	Disabled	
GE5	Disabled	
GE6	Disabled	
GE7	Disabled	
GE8	Disabled	
GE9	Disabled	

Available settings are explained as follows:

Item	Description
Port	Use the drop down list to select the port profile (GE1 to GE12) or profiles.
DoS Protection	Disabled - Disable the function of DoS Protection. Enabled - Enable the function of DoS Protection.
Apply	Apply the settings to the switch.
Modify	- Click it to modify settings.

IV-9 Dynamic ARP Inspection

Dynamic ARP inspection (DAI) can prevent ARP spoofing attacks by validating ARP packet in a network. It can intercept, record, and discard ARP packets with invalid IP-to-MAC address bindings; and then protect the network against malicious attacks.

IV-9-1 Properties

IV-9-1-1 Global Property Settings

This page allows a user to configure global property settings for the function of Dynamic ARP Inspection.

The screenshot displays the configuration interface for Dynamic ARP Inspection. The left sidebar contains a menu with 'Dynamic ARP Inspection' expanded to show 'Properties' and 'Statistics'. The main panel is titled 'Global Property Settings' and includes a breadcrumb trail: 'Security > Dynamic ARP Inspection > Properties > Global Property Settings'. Two tabs are visible: 'Global Property Settings' (selected) and 'Per Port Property Settings'. The 'Global Property Settings' tab contains a 'State' section with an 'Enable' checkbox and a 'VLANs' section with a dropdown menu currently set to 'Nothing selected'. An 'Apply' button is positioned at the bottom right of the configuration area.

Available settings are explained as follows:

Item	Description
State	Enable - Check the box to enable global property settings.
VLANs	Select VLAN profile(s) to apply the function of Dynamic ARP Inspection. Only the GE/LAG port within the selected VLAN will apply DAI function.
Apply	Apply the settings to the switch.

IV-9-1-2 Per Port Property Settings

This page allows a user to configure detailed settings of DAI for each port (GE/LAG).

Available settings are explained as follows:

Item	Description
Ports	Use the drop down list to select the port (GE1 to GE12, LAG1 to LAG8) or ports for applying DAI function.
Trust	Enable - Enable the function of DAI for the port(s) selected above.
Source MAC Address	Enable - Check it to enable the function of source MAC address validation mechanism for the selected port(s).
Destination MAC Address	Enable - Check it to enable the function of destination MAC address validation mechanism for the selected port(s).
IP Address	Enable - Check it to enable the function of IP address validation mechanism for the selected port(s). Allow Zero - The IP address of "0.0.0.0" can be applied to the selected port(s) if it is enabled.
Rate Limit	Use the drop down list to choose a rate limitation value (0~50) for the selected port(s).
Apply	Apply the settings to the switch.

IV-9-2 Statistics

This page displays all statistics recorded by Dynamic ARP Inspection function.

Security > Dynamic ARP Inspection > Statistics > Statistics

Statistics

Refresh Clear All

Port	Forward	Source MAC Failure	Destination MAC Fail...	Source IP Validation ...	Destination IP Valida...	IP-MAC Mismatch Fa...
GE1	0	0	0	0	0	0
GE2	0	0	0	0	0	0
GE3	0	0	0	0	0	0
GE4	0	0	0	0	0	0
GE5	0	0	0	0	0	0
GE6	0	0	0	0	0	0
GE7	0	0	0	0	0	0
GE8	0	0	0	0	0	0
GE9	0	0	0	0	0	0
GE10	0	0	0	0	0	0
GE11	0	0	0	0	0	0
GE12	0	0	0	0	0	0

IV-10 DHCP Snooping

DHCP snooping is able to validate DHCP messages obtained from untrusted sources and filter out invalid message.

For DHCP snooping to function properly, it is suggested to connect DHCP servers to VigorSwitch through trusted interfaces; because untrusted DHCP messages will be forwarded to trusted interfaces only.

IV-10-1 Properties

IV-10-1-1 Global Property Settings

This page allows a user to configure global property settings for the function of DHCP snooping Inspection.

In default, DHCP snooping is inactive on all VLANs. You can enable such feature on a single VLAN or a range of VLANs.

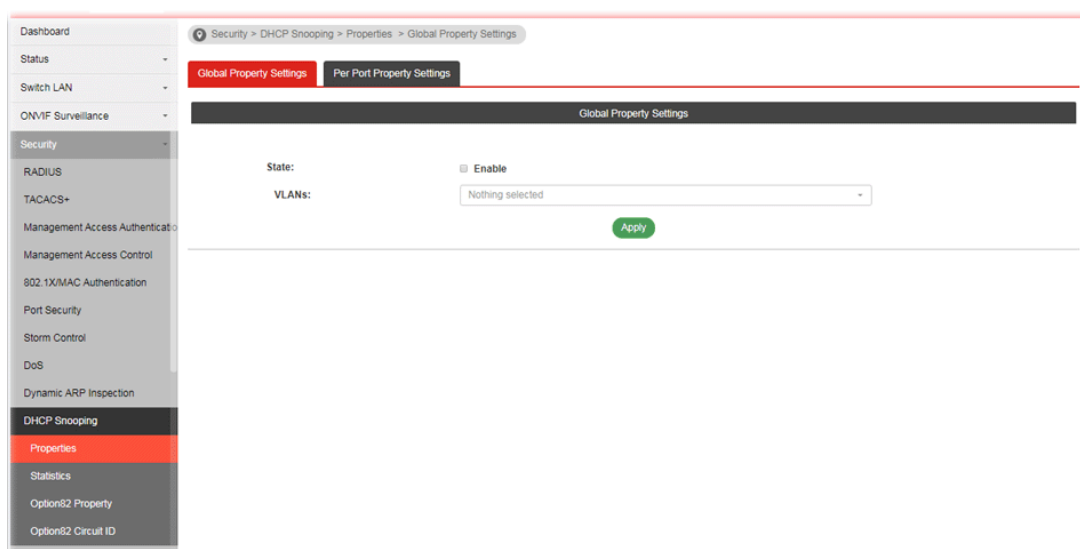

Available settings are explained as follows:

Item	Description
State	Enable - Check the box to enable global property settings.
VLANs	Select VLAN profile(s) to apply the function of DHCP Snooping Inspection. Only the GE/LAG port within the selected VLAN will apply DHCP Snooping function.
Apply	Apply the settings to the switch.

IV-10-1-2 Per Port Property Settings

This page allows a user to configure detailed settings of DHCP Snooping for each port (GE/LAG).

Any device that is not in the service provider network will be regarded as an untrusted source (such as a customer switch). Host ports are untrusted sources. In VigorSwitch, you can assign a source as trusted device by configuring the trust state of its connecting port.

The screenshot shows the 'Per Port Property Settings' page for DHCP Snooping. The configuration options are:

- Ports:** A dropdown menu currently showing 'Nothing selected'.
- Trust:** A radio button labeled 'Enable' is selected.
- Verify Chaddr:** A radio button labeled 'Enable' is selected.
- Rate Limit:** An input field containing '0', with a note 'pps (0 - 300, default 0.0 is Unlimited)'.

Below the configuration options is a table with the following data:

Port	Trust	Verify Chaddr	Rate Limit
GE1	Disabled	Disabled	Unlimited
GE2	Disabled	Disabled	Unlimited
GE3	Disabled	Disabled	Unlimited
GE4	Disabled	Disabled	Unlimited
GE5	Disabled	Disabled	Unlimited
GE6	Disabled	Disabled	Unlimited
GE7	Disabled	Disabled	Unlimited
GE8	Disabled	Disabled	Unlimited

Available settings are explained as follows:

Item	Description
Ports	Use the drop down list to select the port (GE1 to GE12, LAG1 to LAG8) or ports for applying DHCP snooping function.
Trust	Enable - Check it to make the port(s) selected above as trusted interface.
Verify Chaddr	Enable - Check it to enable chaddr (client hardware address) validation of GE/LAG port. All DHCP packets will be checked if the client hardware MAC address is the same as source MAC in Ethernet header or not. Default is disabled.
Rate Limit	Input rate limitation (0~300) of DHCP packets. The unit is "pps". "0" means unlimited. Default is unlimited.
Apply	Apply the settings to the switch.

IV-10-2 Statistics

This page displays all statistics recorded by DHCP snooping function.

Security > DHCP Snooping > Statistics > Statistics

Statistics

Refresh Clear All

Port	Forward	Chaddr Check Drop	Untrust Port Drop	Untrust Port Drop with Opti...	Invalid Drop
GE1	0	0	0	0	0
GE2	0	0	0	0	0
GE3	0	0	0	0	0
GE4	0	0	0	0	0
GE5	0	0	0	0	0
GE6	0	0	0	0	0
GE7	0	0	0	0	0
GE8	0	0	0	0	0
GE9	0	0	0	0	0
GE10	0	0	0	0	0
GE11	0	0	0	0	0
GE12	0	0	0	0	0

IV-10-3 Option82 Property

You can use information settings including Remote ID and Circuit ID for Option82 Property, also known as the DHCP relay agent, to protect VigorSwitch against spoofing attacks.

IV-10-3-1 Global Option82 Property Settings

This page allows a user to set string as remote ID for DHCP option82. For example, use a switch-configured hostname or specify an ASCII text string as remote ID.

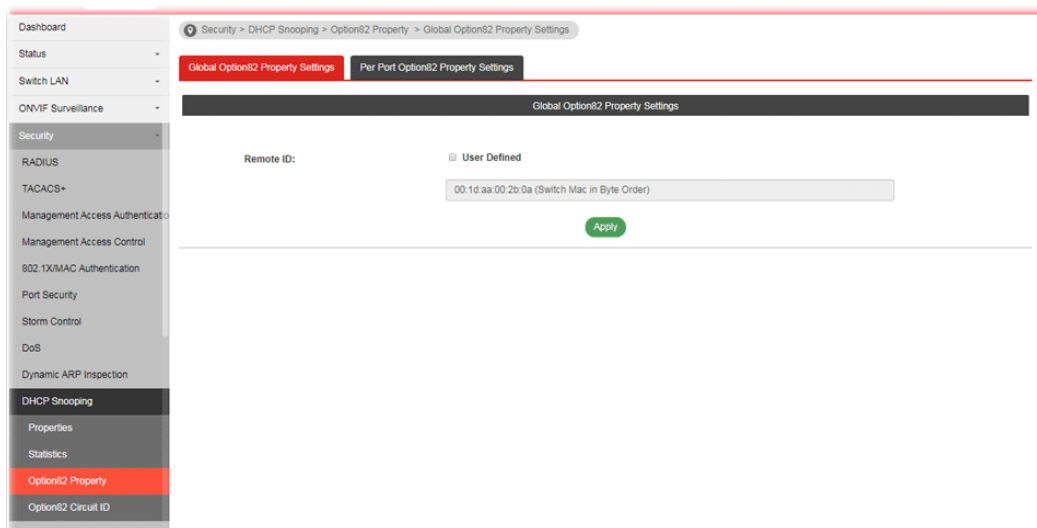

Available settings are explained as follows:

Item	Description
Remote ID	The string specified here is used to identify the remote host. User Defined - Check it and manually enter ASCII text string in the entry box.
Apply	Apply the settings to the switch.

IV-10-3-2 Per Port Option82 Property Settings

This page allows a user to configure detailed settings of DHCP Snooping, Option82 for each port (GE/LAG).

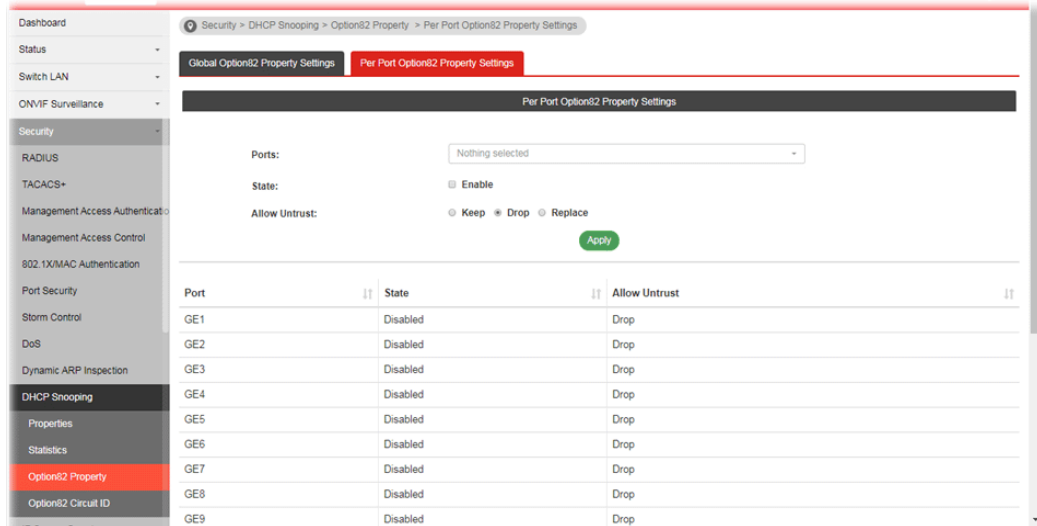

Available settings are explained as follows:



Item	Description
Ports	Use the drop down list to select the port (GE1 to GE12, LAG1 to LAG8) or ports for applying DHCP snooping, Option82 Property function.
State	Enable - Check it to make the port(s) selected above apply the settings configured in this page.
Allow Untrust	Untrusted packets detected by VigorSwitch will be performed by the action determined here. Keep - Packets are allowed to pass through. Drop - Packets are blocked and discarded. Replace - Packets will be replaced.
Apply	Apply the settings to the switch.

IV-10-4 Option82 Circuit ID

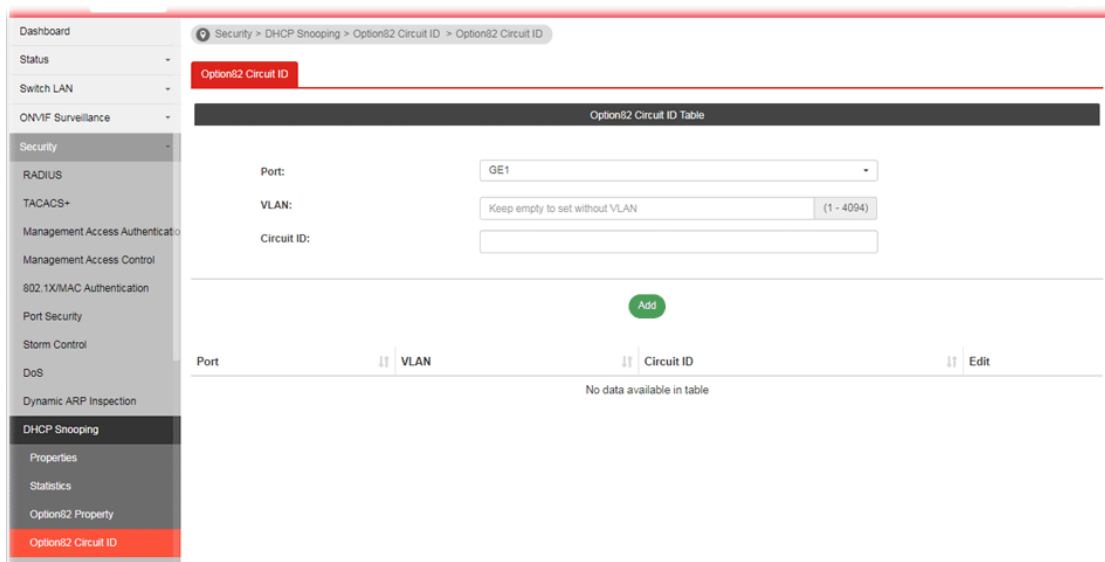
This page allows a user to set string as circuit ID for DHCP option82 setting. Circuit ID shall be combined with VLAN name (or VLAN ID number) and interface name (GE/LAG port).



Available settings are explained as follows:

Item	Description
Ports	Use the drop down list to select the port (GE1 to GE12, LAG1 to LAG8) or ports for applying DHCP snooping, Option82 Property function.
VLAN	Choose a number as VLAN ID which is easy to be identified for a packet containing with it. It is optional setting.
Circuit ID	Enter ASCII text string in the entry box. Later, any packet passes through the specified interface (GE/LAG port) will be inserted with such information.
Add	Click it to create a profile.
Edit	 - click it to modify the circuit ID value for the selected entry.  - click it to remove the selected entry.

IV-11 IP Source Guard

By using the source IP address filtering function, IP source guard can prevent a malicious host from feigning a legal host with its IP address and performing malicious attack.

IV-11-1 Port Settings

IP source guard is a port-based feature. Therefore, it is necessary to configure detailed settings for each GE/LAG port interface separately.

Port	State	Verify Source	Current Entry	Max Entry
GE1	Disabled	IP	0	Unlimited
GE2	Disabled	IP	0	Unlimited
GE3	Disabled	IP	0	Unlimited
GE4	Disabled	IP	0	Unlimited
GE5	Disabled	IP	0	Unlimited
GE6	Disabled	IP	0	Unlimited
GE7	Disabled	IP	0	Unlimited
GE8	Disabled	IP	0	Unlimited

Available settings are explained as follows:

Item	Description
Ports	Use the drop down list to select the port (GE1 to GE12, LAG1 to LAG8) or ports for applying IP source guard function.
State	Enable - Check it to make the port(s) selected above apply the settings configured in this page.
Verify Source	Specify the type of source IP for the packet coming from. IP - Only the packet with specified IP address will be verified. IP-MAC - Only the packet with specified IP address and MAC address will be verified.
Max Entry	Define the number (0-50) for the port. The default is 0 (no limit).
Apply	Apply the settings to the switch.

IV-11-2 IMPV Binding

This page allows the network administrator to set the filtering conditions (binding type, MAC address, IPv4 address) for packets through the specified LAN port.

Available settings are explained as follows:

Item	Description
Ports	Use the drop down list to select the port (GE1 to GE12, LAG1 to LAG8) or ports for applying IMPV Binding function.
VLAN	Choose a number as VLAN ID which is easy to be identified for a packet containing with it. It is optional setting.
Binding	Select the binding type for such feature. IP-MAC-Port-VLAN - Packets will be allowed to pass through the port interface if they meet the conditions specified by IP address, MAC address, Port setting and VLAN ID setting. IP-Port-VLAN - Packets will be allowed to pass through the port interface if they meet the conditions specified by IP address, Port setting and VLAN ID setting.
MAC Address	Enter the MAC address of the device connecting to the port interface selected above.
IPv4 Address	Enter the IP address with mask address of the device connecting to the port interface selected above.
Add	Click it to create a new binding profile.
Edit	 - Click it to modify the settings for the selected entry.

✕

Edit

Ports:

VLAN: (1 - 4094)

Binding: IP-MAC-Port-VLAN IP-Port-VLAN

MAC Address:

IPv4 Address: /



- click it to remove the selected entry.

IV-12 IP Conflict Prevention

A user can configure IP addresses for network devices manually. However, it might result in conflict between different devices due to using the same IP address, and cause the devices not working correctly.

This page allows you to prevent IP conflict by binding the port with the specified IP address.

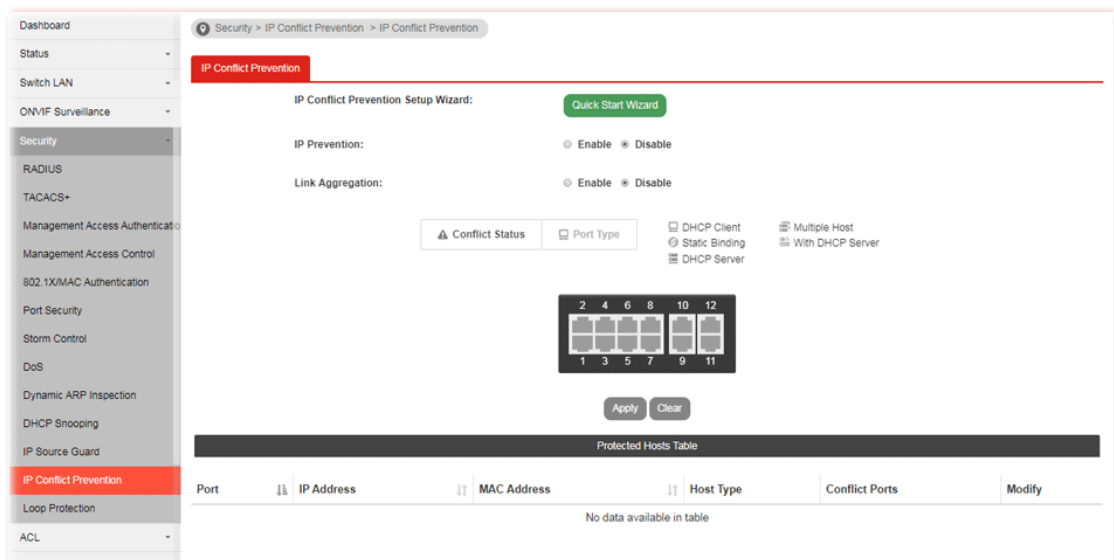

Available settings are explained as follows:

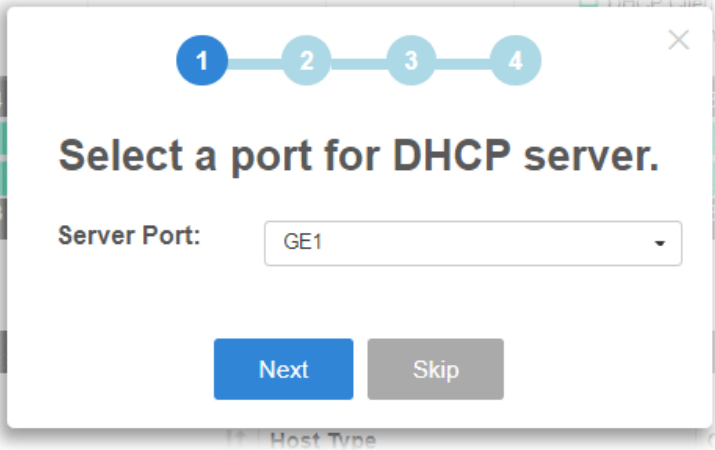

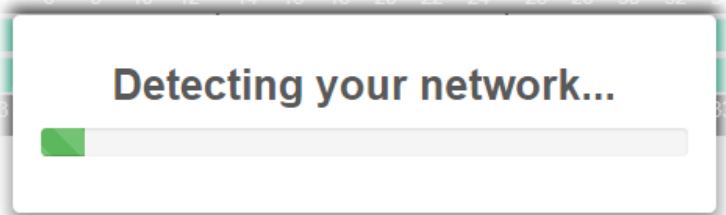
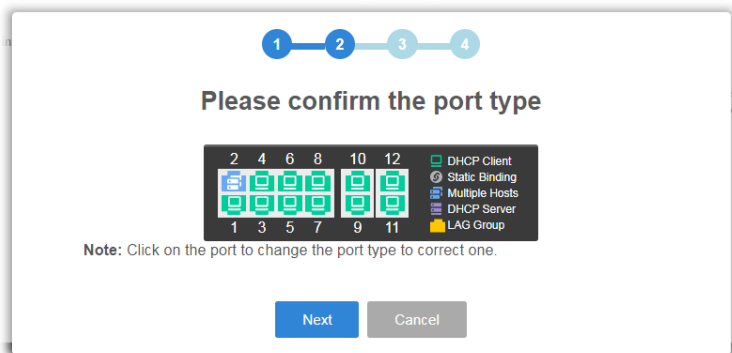
Item	Description
IP Conflict Prevention Setup Wizard	<p>Quick Start Wizard - The system will guide to bind server port with an IP address step by step.</p> <p>Step 1</p>  <p>Step 2</p>

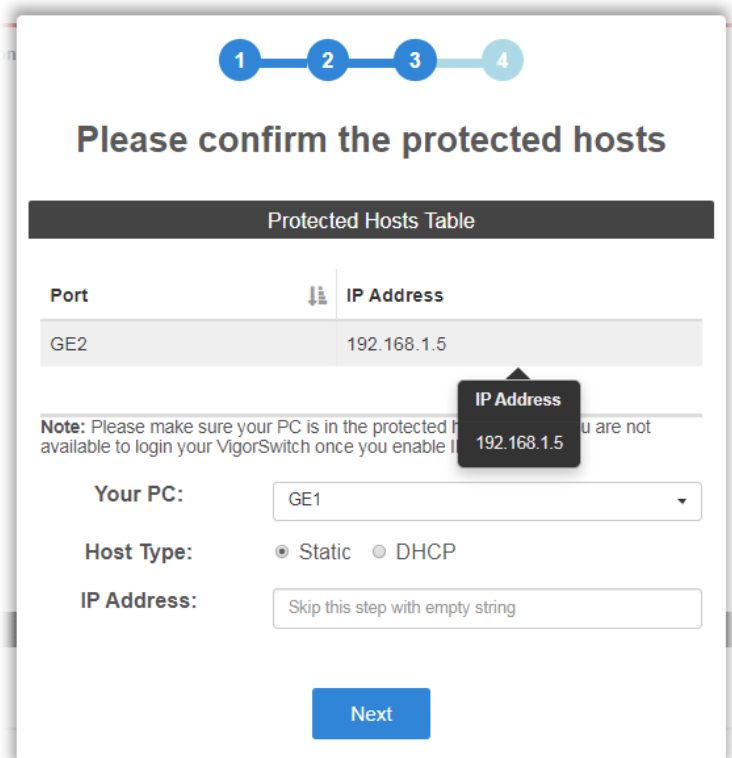

Step 3

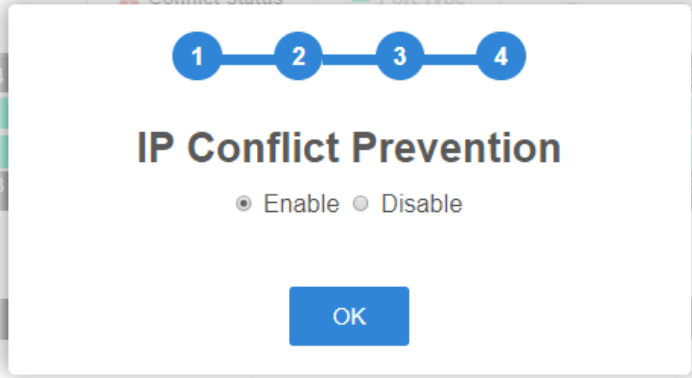

Step 4

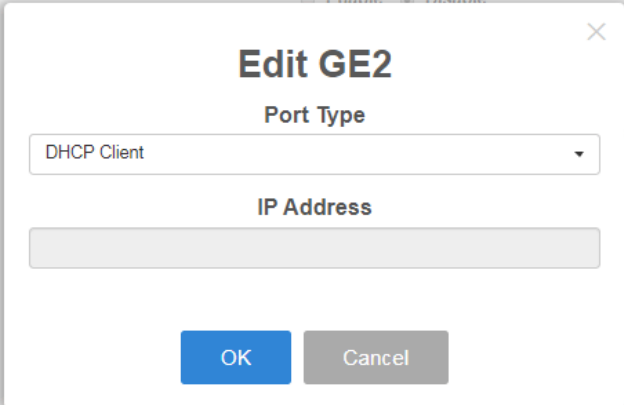
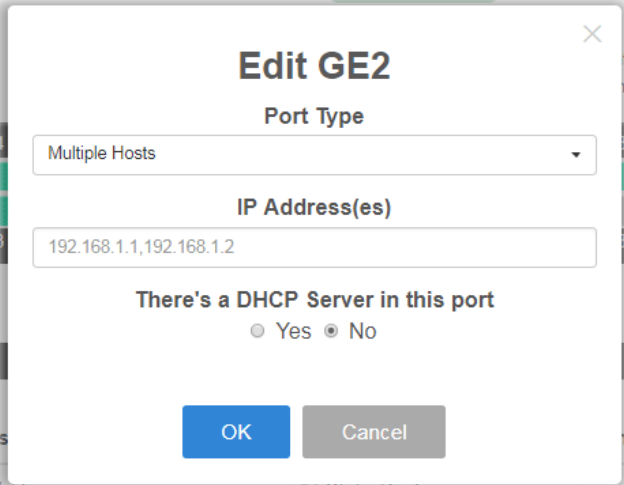
	 <p>After clicking OK, the IP address specified for the GE port will be unavailable for other network devices.</p>
IP Prevention	<p>Enable - Click it to activate the function of IP prevention. Disable - Click it to deactivate the function of IP prevention.</p>
Apply	Apply the settings to the switch.
Clear	Remove all settings of IP source guard DHCP snooping and dynamic ARP inspection.
Modify	 - Click it to modify the settings for the selected entry.   <p>Port Type - There are four selections - DHCP Client, Static Binding, Multiple Hosts and DHCP Server. Each type will bring out different IP address(es) settings.</p>

OK - Click it to save the settings.



- Click it to remove the selected entry.

IV-13 Loop Protection

Loop event might be caused due to wrong hardware connection. VigorSwitch will periodically send packets out to check if they loopback or not. This page allows you to set conditions and perform an action when VigorSwitch detects the looped packet.

The screenshot shows the 'Loop Protection Setting' page in the VigorSwitch web interface. The left sidebar menu is expanded to show 'Loop Protection' in red. The main content area has a breadcrumb trail: 'Security > Loop Protection > Loop Protection Setting'. Below this, there's a 'Loop Protection Setting' header. The settings are as follows:

- State:** Enable Disable
- Transmission Time:** A text input field containing 'Seconds' and a label '(1-3 sec.)' to its right.
- Action:** A dropdown menu with 'Select Action' as the current selection.

Below the settings is a green 'Apply' button. At the bottom, there is a table with the following data:

State	Transmission Time	Action
DISABLED	1	Shutdown Port

Available settings are explained as follows:

Item	Description
State	<ul style="list-style-type: none"> ● Enable - VigorSwitch detects the loop event of GE ports/LAG ports automatically. ● Disable - VigorSwitch will not detect the loop event.
Transmission Time	When the loop event occurred, VigorSwitch will perform the action after a period of time.
Action	<p>When the switch detects loop situation occurred to a port; it will perform the action selected in this field.</p> <ul style="list-style-type: none"> ● Log - The switch will record such event as a log. ● Shutdown Port - The switch will shut down the port. ● Shutdown Port and Log - The switch will shut down the port and record the event as a log. The system administrator will view the content from system log.
Apply	Apply the settings to the switch.

Part V ACL Configuration

V-1 Create ACL

An Access Control List (ACL) is a sequential list of permit or deny conditions that apply to IP addresses, MAC addresses, or other more specific criteria. This switch tests ingress packets against the conditions in an ACL one by one. A packet will be accepted as soon as it matches a permit rule, or dropped as soon as it matches a deny rule. If no rules match, the frame is accepted.

V-1-1 MAC

The function is used to show the Access Control List (ACL) based on Layer 2 filtering, the MAC layer. The ACL is composed by many Access Control Element (ACE) rules. You can create a new ACL here; then add multiple ACEs.

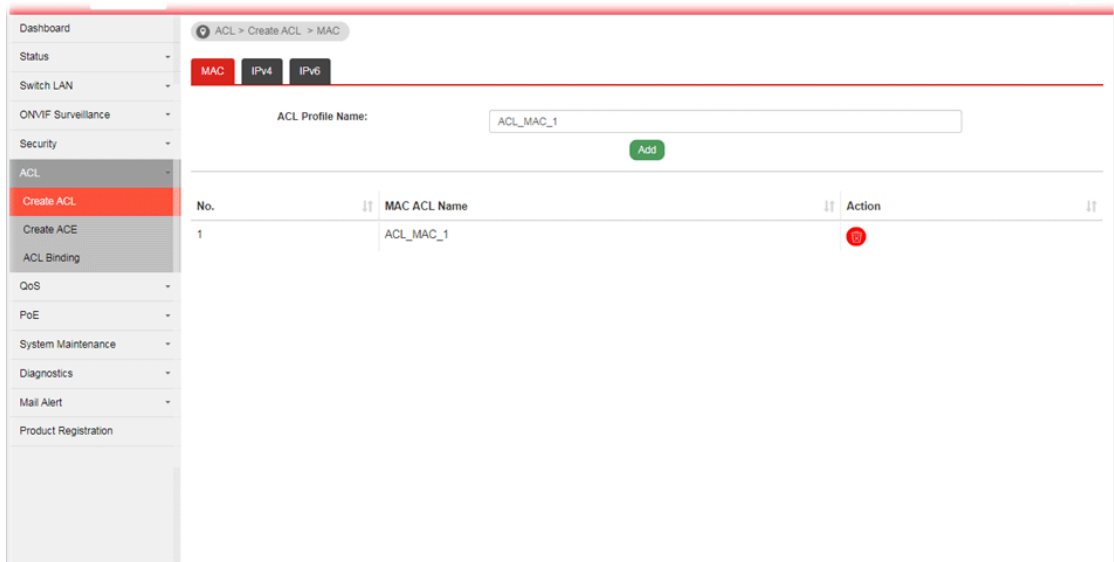

Available settings are explained as follows:

Item	Description
ACL Profile Name	Enter a name for creating a new ACL profile.
Add	Add a new ACL entry using given ACL name.
Action	- click it to remove the selected entry.

V-1-2 IPv4

The function is used to show the Access Control List (ACL) based on Layer 2 to Layer 4 filtering, the IPv4. The ACL is composed by many Access Control Element (ACE) rules. You may create a new ACL here; then add multiple ACEs.

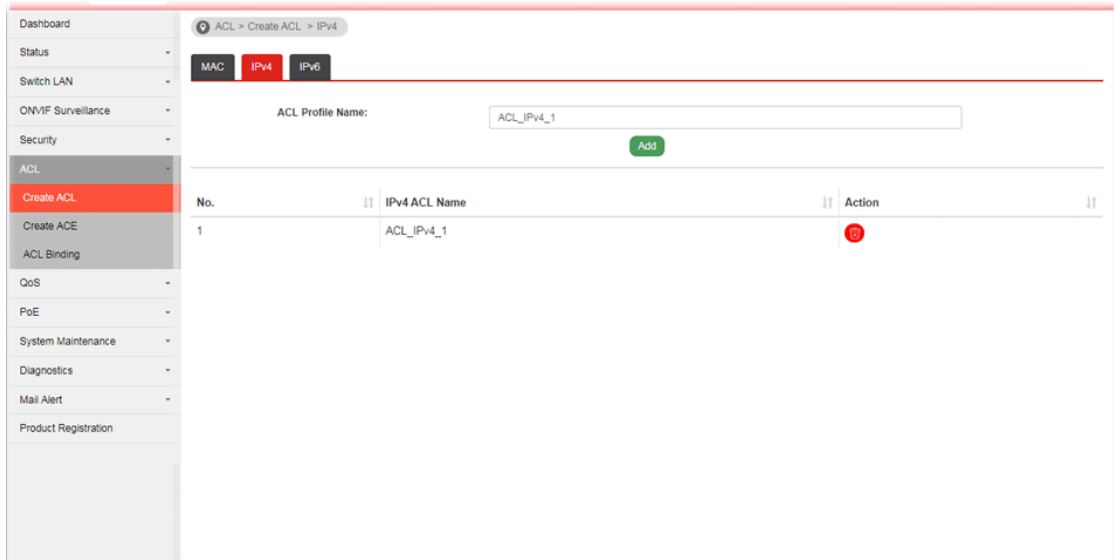

Available settings are explained as follows:

Item	Description
ACL Profile Name	Enter a name for creating a new ACL profile.
Add	Add a new ACL entry using given ACL name.
Action	- click it to remove the selected entry.

V-1-3 IPv6

The function is used to show the Access Control List (ACL) based on Layer 2 to Layer 4 filtering, the IPv6. The ACL is composed by many Access Control Element (ACE) rules. You may create a new ACL here; then add multiple ACEs.

No.	IPv6 ACL Name	Action
1	ACL_IP6_I2	

Available settings are explained as follows:

Item	Description
ACL Profile Name	Enter a name for creating a new ACL profile.
Add	Add a new ACL entry using given ACL name.
Action	- click it to remove the selected entry.



V-2 Create ACE

Since ACL based on MAC, IPv4 and/or IPv6 has been created on the section of IV-1, now you can add multiple ACE rules for each ACL.

V-2-1 MAC



This page shows ACE based on MAC address. You may choose ACL, permit, and deny particular packet or frame, even shutdown the port.

You may provide filtering/matching criteria for one or more of packet characteristic (such as Source/Destination MAC, Ethertype, VLAN, 802.1p) for this ACE to identify the packet.

No.	Name	Sequence	Action	Source MAC/Mask	Destination MAC/...	Ethertype	VLAN	802.1p	Modify
1	ACL_MAC_1	1	Permit	Any/Any	Any/Any	Any	Any	Any/Any	 

Available settings are explained as follows:

Item	Description
ACL Profile Name	Use the drop down list to selected one of the user defined ACL profiles.
Sequence	Assign a sequence number to this ACE. The sequence is used to identify which one of ACEs in an ACL is firstly used to match ingress packets. The switch port bound with an ACL use the contained ACE rules, start with the one with lower sequence number to match the packet first.
Action	Select the action applied to the packet matched this ACE. Permit or deny the packets into switch core, or shutdown the port for stopping further transmission. <ul style="list-style-type: none"> ● Permit ● Deny ● Shutdown
Source MAC / Destination MAC	Specify the source and the destination MAC address for filtering.

	<p>Any - All packets will be filtered. Or, enter the IP address to filter the packets coming from that address.</p>
Ethertype	<p>Specify ethernet type for filtering. Select Any. Or, enter the value with the format of "0x600 ~ 0xFFFF".</p>
VLAN	<p>Specify VLAN profile for filtering. Select Any. Or, enter a VLAN number. The packets coming from the VLAN specified here will be filtered by Vigor device.</p>
802.1p	<p>Specify the 802.1p priority value for filtering. Select Any, or a number from 0 to 7.</p>
Add	<p>Click it to create a new ACE rule.</p>
Modify	<p> - click it to modify the settings for the selected entry.</p> <div data-bbox="737 808 1284 1568" style="border: 1px solid #ccc; padding: 10px; margin: 10px auto; width: fit-content;"> <p style="text-align: center;">Edit ACE ACL_1_carrie ✕</p> <p>Sequence: <input type="text" value="1"/> ⌵</p> <p>Action: <input type="text" value="Permit"/> ▾</p> <p>Source MAC: <input checked="" type="checkbox"/> Any</p> <p><input type="text" value="00:00:00:00:00:00"/> / <input type="text" value="FF:FF:FF:FF:FF:00"/></p> <p>Destination MAC: <input checked="" type="checkbox"/> Any</p> <p><input type="text" value="00:00:00:00:00:00"/> / <input type="text" value="FF:FF:FF:FF:FF:00"/></p> <p>Ethertype: <input checked="" type="checkbox"/> Any</p> <p><input type="text" value="(0x600-0xFFFF)"/> (0x600-0xFFFF)</p> <p>VLAN: <input checked="" type="checkbox"/> Any</p> <p><input type="text" value="(1-4094)"/> (1-4094)</p> <p>802.1p: <input checked="" type="checkbox"/> Any</p> <p><input type="text" value="0-7"/> / <input type="text" value="0-7"/> ⌵</p> <p style="text-align: center;"><input type="button" value="OK"/> <input type="button" value="Cancel"/></p> </div> <p> - click it to remove the selected entry.</p>

V-2-2 IPv4

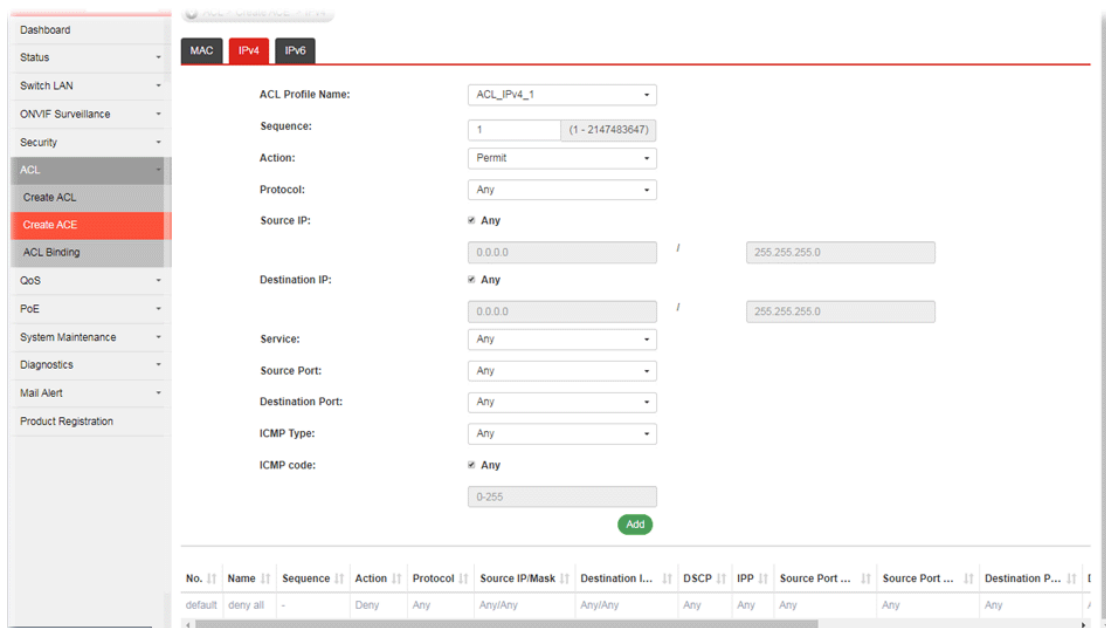

This page shows ACE based on IPv4 address. You may choose ACL, permit, and deny particular packet or frame, even shutdown the port.

You may provide filtering/matching criteria for one or more of following packet characteristic (such as Protocol over the IP layer, Source/Destination IPv4 address, Type of Service, Source/Destination port number, TCP flags, ICMP Type, if chosen protocol contains ICMP), for this ACE to identify the packet.



Available settings are explained as follows:

Item	Description
ACL Profile Name	Use the drop down list to selected one of the user defined ACL profiles.
Sequence	Assign a sequence number to this ACE. The sequence is used to identify which one of ACEs in an ACL is firstly used to match ingress packets. The switch port bound with an ACL use the contained ACE rules, start with the one with lower sequence number to match the packet first.
Action	Select the action applied to the packet matched this ACE. Permit or deny the packets into switch core, or shutdown the port for stopping further transmission. <ul style="list-style-type: none"> ● Permit ● Deny ● Shutdown
Protocol	Specify the protocol for filtering. Any - All packets will be filtered. Select - Choose one of the protocol (e.g., ICMP, IP in IP, TCP, EGP, IGP...) from the drop down list. Packets passing through the selected protocol will be filtered. Define - Specify a type number (0 - 255) for ICMP code. For example, 0 means "Echo Reply"; 254 means "RFC3692-style Experiment 2".
Source IP / Destination IP	Specify the source and the destination IPv4 address for filtering. Any - All packets will be filtered. Or, enter the IP address to filter the packets coming from that address.
Service	Any - All packets will be filtered. DSCP - All IP traffic is mapped to queues based on the DSCP field in the IP header. If traffic is not IP traffic, it is mapped to the lowest priority queue.

	<p>IP Precedence - All IP traffic is mapped to queues based on the IP Precedence field in the IP header. If traffic is not IP traffic, it is mapped to the lowest priority queue.</p>
Source Port / Destination Port	<p>Specify the source and destination port number for filtering the packets.</p> <p>Any - All packets will be filtered.</p> <p>Single - Only the packets passing through the number defined here will be filtered.</p> <p>Range - Only the packets passing through the port range defined here will be filtered.</p>
ICMP Type	<p>Any - All packets will be filtered.</p> <p>Select - Choose one of the type (e.g., Destination Unreachable Echo Reply, MLD Query....) from the drop down list.</p> <p>Define - Specify a type number (0 - 255) for ICMP code. For example, 0 means "Echo Reply"; 254 means "RFC3692-style Experiment 2".</p>
ICMP code	<p>Each ICMP type can be defined with different codes. For example, if you define ICMP Type as "3", then the available codes for Type 3 will be 0-15.</p> <p>Any - All packets will be filtered.</p> <p>Or, enter 0 to 255 based on the ICMP type specified.</p>
Add	Click it to create a new binding profile.
Modify	<p> - click it to modify the settings for the selected entry.</p> <p> - click it to remove the selected entry.</p>

V-2-3 IPv6

This page allows the network administrator to create ACE based on IPv6 address.



The screenshot displays the 'Create ACE' configuration page for IPv6. The form includes the following fields:

- ACL Profile Name:** A dropdown menu with 'ACL_IP6_12' selected.
- Sequence:** A text input field containing '1' and a range '(1 - 2147483647)'.
- Action:** A dropdown menu with 'Permit' selected.
- Protocol:** A dropdown menu with 'Any' selected.
- Source IP:** A radio button for 'Any' and a text input field.
- Destination IP:** A radio button for 'Any' and a text input field.
- Service:** A dropdown menu with 'Any' selected.
- Source Port:** A dropdown menu with 'Any' selected.
- Destination Port:** A dropdown menu with 'Any' selected.
- ICMP Type:** A dropdown menu with 'Any' selected.
- ICMP code:** A radio button for 'Any' and a text input field containing '0-255'.

At the bottom of the form is a table with columns: No., Name, Sequence, Action, Protocol, Source IP/Mask, Destination L..., DSCP, IPP, Source Port..., Source Port..., Destination P... The table shows a single entry: 'default deny all - Deny Any Any/Any Any/Any Any Any Any Any Any'.

Available settings are explained as follows:

Item	Description
ACL Profile Name	Use the drop down list to selected one of the user defined ACL profiles.
Sequence	Assign a sequence number to this ACE. The sequence is used to identify which one of ACEs in an ACL is firstly used to match ingress packets. The switch port bound with an ACL use the contained ACE rules, start with the one with lower sequence number to match the packet first.
Action	Select the action applied to the packet matched this ACE. Permit or deny the packets into switch core, or shutdown the port for stopping further transmission. <ul style="list-style-type: none"> ● Permit ● Deny ● Shutdown
Protocol	Specify the protocol for filtering. Any - All packets will be filtered. Select - Choose one of the protocol (e.g., ICMP, TCP, EGP...) from the drop down list. Packets passing through the selected protocol will be filtered. Define - Specify a type number (0 - 255) for ICMP code. For example, 0 means "Echo Reply"; 254 means "RFC3692-style Experiment 2".
Source IP / Destination IP	Specify the source and the destination IPv6 address for filtering. Any - All packets will be filtered. Or, enter the IPv6 address to filter the packets coming from

	that address.
Service	<p>Any - All packets will be filtered.</p> <p>DSCP - All IP traffic is mapped to queues based on the DSCP field in the IP header. If traffic is not IP traffic, it is mapped to the lowest priority queue.</p> <p>IP Precedence - All IP traffic is mapped to queues based on the IP Precedence field in the IP header. If traffic is not IP traffic, it is mapped to the lowest priority queue.</p>
Source Port / Destination Port	<p>Specify the source and destination port number for filtering the packets.</p> <p>Any - All packets will be filtered.</p> <p>Single - Only the packets passing through the number defined here will be filtered.</p> <p>Range - Only the packets passing through the port range defined here will be filtered.</p>
ICMP Type	<p>Any - All packets will be filtered.</p> <p>Select - Choose one of the type (e.g., Destination Unreachable Echo Reply, MLD Query....) from the drop down list.</p> <p>Define - Specify a type number (0 - 255) for ICMP code. For example, 0 means "Echo Reply"; 254 means "RFC3692-style Experiment 2".</p>
ICMP code	<p>Each ICMP type can be defined with different codes. For example, if you define ICMP Type as "3", then the available codes for Type 3 will be 0-15.</p> <p>Any - All packets will be filtered.</p> <p>Or, enter 0 to 255 based on the ICMP type specified.</p>
Add	Click it to create a new binding profile.
Modify	<p> - Click it to modify the settings for the selected profile.</p> <p> - Click it to remove the selected entry.</p>

V-3 ACL Binding

This section allows you to bind Access Control Lists created in previous section to an interface (physical port or aggregation).

A physical port can only be bound with one of the IPv4 and IPv6 ACL, not both.

Port	MAC ACL	IPv4 ACL	IPv6 ACL
GE1			
GE2			
GE3			
GE4			
GE5			
GE6			
GE7			
GE8			
GE9			
GE10			
GE11			
GE12			

Available settings are explained as follows:

Item	Description
Ports	Use the drop down list to select the port profiles (GE1 to GE12) for binding ACL.
MAC ACL / IPv4 ACL / IPv6 ACL	Select ACLs (MAC, IPv4, and/or IPv6) to be bound on this interface (port), so Switch may filter packets by using it.
Apply	Apply the settings to the switch.

This page is left blank.

Part VI QoS Configuration

VI-1 General

QoS (Quality of Service) functions to provide different quality of service for various network applications and requirements and optimize the bandwidth resource distribution so as to provide a network service experience of a better quality.

VI-1-1 Properties

VI-1-1-1 QoS General Setting

This page allows the network administrator to specify Ingress Trust Mode for basic QoS mode.

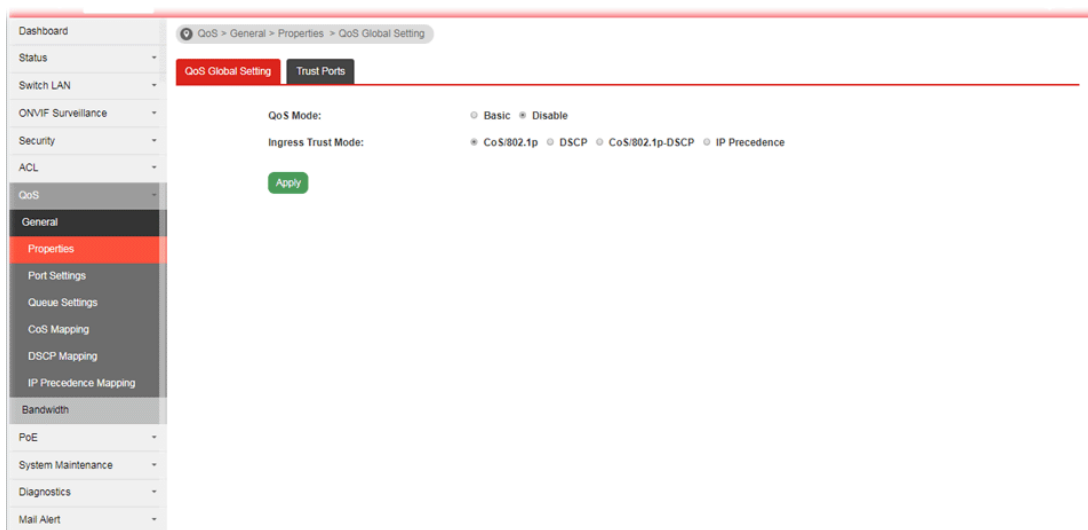

Available settings are explained as follows:

Item	Description
QoS Mode	Disable -Disable the function of QoS mode. Basic - Enable the function of QoS mode.
Ingress Trust Mode	Select the QoS operation mode. CoS/802.1p -Traffic is mapped to queues based on the CoS field in the VLAN tag, or based on the per-port default CoS value if there is no VLAN tag on the incoming packet. DSCP - All IP traffic is mapped to queues based on the DSCP field in the IP header. If traffic is not IP traffic, it is mapped to the lowest priority queue. CoS/802.1p-DSCP - All IP traffic is mapped to queues based on the DSCP field in the IP header. If traffic is not IP but has VLAN tag, mapped to queues based on the CoS value in the VLAN tag. IP Precedence - All IP traffic is mapped to queues based on the DSCP field in the IP header. If traffic is not IP but has VLAN tag, mapped to queues based on the CoS value in the VLAN tag.
Apply	Apply the settings to the switch.

VI-1-1-2 Trust Ports

This page allows the network administrator to enable the trust mode of basic QoS on each port. Port that is trust disabled will be sent with lowest priority queue. The configuration result for each port will be displayed on the table listed on the lower side of this web page.

Port	Trust
GE1	Enabled
GE2	Enabled
GE3	Enabled
GE4	Enabled
GE5	Enabled
GE6	Enabled
GE7	Enabled
GE8	Enabled
GE9	Enabled

Available settings are explained as follows:

Item	Description
Ports	Use the drop down list to select the port profile (GE1 to GE12) or profiles.
Trust	Click Enable to make traffic follow the trust mode in general setting. Enable - Traffic will follow trust mode in general setting. Disable - No QoS service for this port.
Apply	Apply the settings to the switch.

VI-1-2 Port Settings

This page allows the network administrator to configure port settings for QoS. The configuration result for each port will be displayed on the table listed on the lower side of this web page.

Available settings are explained as follows:

Item	Description
Ports	Use the drop down list to select the port profile (GE1 to GE12) or profiles.
Ingress Default CoS	Specify the default CoS priority value for those ingress frames without given trust QoS tag (802.1q/DSCP/IP Precedence, depending on configuration).
Egress Remarking	
Remark CoS	Disable - Disable CoS remarking function for outgoing packets. Enable - Egress traffic will be marked with CoS value according to the Queue to CoS mapping table.
Remark DSCP/IP Precedence	Disable - Disable DSCP/IP Precedence remarking function for outgoing packets. DSCP - Egress traffic will be marked with DSCP value according to the Queue to DSCP mapping table. IP Precedence - Egress traffic will be marked with IP Precedence value according to the Queue to IP Precedence mapping table.
Apply	Apply the settings to the switch.
Modify	 - Click it to modify the settings for the selected port profile.

VI-1-3 Queue Settings

VigorSwitch supports multiple queues for each interface. The higher numbered queue represents the higher priority. The following lists the types of supported priority queue:

- Strict Priority (SP) - Egress traffic from the higher priority queue will be transmitted first, lower priority queue shall wait until all traffic in SP queue is transmitted.
- Weighted Round Robin (WRR) - The number of packets sent from the queue is proportional to the weight of the queue.

Queue	Schedule	Weight	% of WRR Bandwidth
1	<input checked="" type="radio"/> Strict Priority <input type="radio"/> WRR	<input type="text" value="0"/>	
2	<input checked="" type="radio"/> Strict Priority <input type="radio"/> WRR	<input type="text" value="0"/>	
3	<input checked="" type="radio"/> Strict Priority <input type="radio"/> WRR	<input type="text" value="0"/>	
4	<input checked="" type="radio"/> Strict Priority <input type="radio"/> WRR	<input type="text" value="0"/>	
5	<input checked="" type="radio"/> Strict Priority <input type="radio"/> WRR	<input type="text" value="0"/>	
6	<input checked="" type="radio"/> Strict Priority <input type="radio"/> WRR	<input type="text" value="0"/>	
7	<input checked="" type="radio"/> Strict Priority <input type="radio"/> WRR	<input type="text" value="0"/>	
8	<input checked="" type="radio"/> Strict Priority <input type="radio"/> WRR	<input type="text" value="0"/>	

Strict Priority Queue Number 8

Available settings are explained as follows:

Item	Description
Queue	There are eight queue ID numbers allowed to be configured.
Schedule	Strict Priority - Click it to set queue to strict priority type. WRR - Click it to set queue to Weight round robin type.
Weight	If the queue type is WRR, set the queue weight for the queue.
% of WRR Bandwidth	Display the percentage of traffic which can be sent by current queue compared to total WRR queues.
Apply	Apply the settings to the switch.
Strict Priority Queue Number	Display the number of queues using Strict Priority method.

VI-1-4 CoS Mapping

This section allows user to configure how ingress frames with CoS/802.1p tag map to QoS queues, and QoS queues to CoS/802.1p on egress frames.

Actual effectiveness is based on how QoS is configured in previous QoS section. This page provides settings for user to configure mapping only.

Available settings are explained as follows:

Item	Description
CoS to Queue Mapping (for Ingress) - Settings for incoming packets.	
Class of Service	Display the class of service value (0 to 7).
Queue	Define the queue ID (level 1 to 8) for different class of service values.
Queue to CoS Mapping (for Egress Remarking) - Settings for outgoing packets.	
Queue	Display the queue ID (level 1 to 8) for different class of service values.
Class of Service	Define the class of service value (0 to 7).
Apply	Apply the settings to the switch.

VI-1-5 DSCP Mapping

This section allows user to configure how ingress packets with DSCP tag map to QoS queues, and QoS queues to DSCP on egress packets.

Actual effectiveness is based on how QoS is configured in previous QoS section. This page provides settings for user to configure mapping only.

Available settings are explained as follows:

Item	Description
DSCP to Queue Mapping (for Ingress) - Settings for the incoming packets.	
DSCP	Display the DSCP value (0 to 7).
Queue	Define the queue ID (level 1 to 8) for different DSCP values.
Queue to DSCP Mapping (for Egress Remarking) - Settings for outgoing packets.	
Queue	Display the queue ID (level 1 to 8) for different DSCP values.
DSCP	Define the DSCP value (0 to 7).
Apply	Apply the settings to the switch.

VI-1-6 IP Precedence Mapping

This section allows user to configure how ingress packets with IP Precedence tag map to QoS queues, and QoS queues to IP Precedence on egress packets.

Actual effectiveness is based on how QoS is configured in previous QoS section. This page provides settings for user to configure mapping only.

Available settings are explained as follows:

Item	Description
IP Precedence to Queue Mapping (for Ingress) - Settings for the incoming packets.	
IP Precedence	Display the IP Precedence value (0 to 7).
Queue	Define the queue ID (level 1 to 8) for different IP Precedence values.
Queue to IP Precedence Mapping (for Egress Remarking) - Settings for outgoing packets.	
Queue	Display the queue ID (level 1 to 8) for different IP Precedence values.
IP Precedence	Define the IP Precedence value (0 to 7).
Apply	Apply the settings to the switch.

VI-2 Bandwidth

Use the bandwidth setting pages to define values that determine how much traffic the switch can receive and send on specific port or queue.

VI-2-1 Ingress Rate Limit

This page allows a user to configure ingress port rate limit. The ingress rate limit is the number of bits per second that can be received from the ingress interface. Excess bandwidth above this limit is discarded. The configuration result for each port will be displayed on the table listed on the lower side of this web page.

Available settings are explained as follows:

Item	Description
Ingress Rate Limit	
Ports	Use the drop down list to select the port profile (GE1 to GE12) or profiles.
State	Disable - Disable ingress bandwidth control. Enable - Enable ingress bandwidth control.
Rate (Kbps)	Enter the rate value,<16-1000000>,unit:16 Kbps.
Apply	Apply the settings to the switch.
Modify	 - Click it to modify the settings for the selected port profile.

VI-2-2 Egress Shaping Rate

This page allows a user to configure egress port rate limit. The egress rate limit is the number of bits per second that can be received from the egress interface. Excess bandwidth above this limit is discarded.

Available settings are explained as follows:

Item	Description
Egress Shapping Rate	
Ports	Use the drop down list to select the port profile (GE1 to GE12) or profiles.
State	Disable - Disable egress bandwidth control. Enable - Enable egress bandwidth control.
CIR (Kbps)	Enter the rate value, <16-1000000>, unit: 16 Kbps.
Apply	Apply the settings to the switch.
Modify	 - Click it to modify the settings for the selected port profile.

VI-2-3 Egress Shaping Per Queue

This page allows user to configure the maximum egress bandwidth not only by port but also by specific QoS queues. The configuration result for each port will be displayed on the table listed on the lower side of this web page.

Available settings are explained as follows:

Item	Description
Egress Shapping Per Queue	
Port	Use the drop down list to select the port profile (GE1 to GE12) or profiles.
Queue	Use the drop down list to select queue number (1 to 8) for the selected GE port.
State	Disable - Disable egress bandwidth control. Enable - Enable egress bandwidth control.
CIR (Kbps)	Enter the rate value, <16-1000000>, unit: 16 Kbps.
Apply	Apply the settings to the switch.

This page is left blank.

Part VII PoE Configuration

VII-1 Properties

This page allows a user to configure general settings for PoE and configure priority of each port for supplying PoE power. While maximum power budget is reached, power will be served starting with critical priority.

If the priority setting for all GE ports is configured as the same value (e.g., High); then, GE1 will have the highest priority to obtain PoE power in actual operation.

Available settings are explained as follows:

Item	Description
PoE Mode	<p>Disable - Disable the PoE function.</p> <p>Auto - Provides plug and play PoE function. PoE schedule and Power Limit are disabled in this mode.</p> <p>Manual - Before using PoE>>Schedule, set Manual as PoE mode.</p>
Ports	Use the drop down list to select the port (GE1 to GE8) or ports for applying PoE configuration.
Enable	<p>Enable - Make the selected ports be applied with PoE mode.</p> <p>Disable - Make the selected ports be not applied with PoE mode.</p>
Priority	<p>Select Priority for PoE device.</p> <p>Low -Set PoE device to low priority connection.</p> <p>High -Set PoE device to high priority connection.</p> <p>Critical - Set PoE device to highest priority connection.</p>
Power Limit	This setting is available when Manual is selected as PoE Mode. Enter the value as the maximum limit of power given to each physical port.
Apply	Apply the settings to the switch.

VII-2 Status

This page displays the current PoE status (configured in Properties, Device Check and Schedule) for each PoE port.

Port	Enable	Status	PD Class	Priority	Power Used (W)	Power Limit (W)	Power Cycle
GE1	Enabled	No PD	---	Low	0	AT (30)	<input type="button" value="Apply"/>
GE2	Enabled	ON	0 (15.4W)	Low	4.1	AT (30)	<input type="button" value="Apply"/>
GE3	Enabled	No PD	---	Low	0	AT (30)	<input type="button" value="Apply"/>
GE4	Enabled	No PD	---	Low	0	AT (30)	<input type="button" value="Apply"/>
GE5	Enabled	No PD	---	Low	0	AT (30)	<input type="button" value="Apply"/>

Available settings are explained as follows:

Item	Description
Refresh	Click it to refresh the status page.
PoE Mode	Display the PoE Mode (Manual, Auto or Disable) selected for the LAN port.
Power Budget(W)	Display the maximum power this switch can supply over PoE.
Consuming Power(W)	Display current power being consumed by all devices over PoE.
Remaining Power(W)	Display remaining power that can be supplied to additional devices over PoE.
Power Cycle	Apply - If PoE device connects to VigorSwitch, such button will be available for you to manually perform the cold boot for the PoE device by cycling the power supply.

VII-3 Schedule

VII-3-1 Schedule Profile

This page allows the network administrator to configure maximum 15 PoE schedule rules.

Available settings are explained as follows:

Item	Description
Schedule Index	Use the drop down list (1 to 15) to choose one schedule profile.
Enable	Disable - The selected schedule profile will not take action but be saved for future use. Enable - The selected schedule profile will take action as configured.
Description	Enter a brief comment for such schedule.
Start Date	Specify the starting date of the schedule by choosing from a drop down calendar.
Start Time	Specify the starting time of the schedule by using the drop down list to specify the starting time (hours and minutes).
Duration Time	Define the time duration (hours and minutes).
Action	Specify which action should perform during the period of the schedule. Power On - PoE connection is always on. Power Off - PoE connection is always down.
How Often	Specify how often the schedule will be applied. Once - The schedule will be applied just once. Weekdays - Specify which days in one week should perform the schedule. Monthly, on date - Specify the day in a month as the starting point. Cycle duration (days) - The period of cycle duration is

	between 1 day and 31 days. For example, 7 means the whole cycle is 7 days; 20 means the whole cycle is 20 days. When the time is up, the PoE device will be turned on or off automatically.
Apply	Apply the settings to the switch.

VII-3-2 Port Scheduling

This page allows the network administrator to specify the PoE port for applying the schedule. The configuration result for each port will be displayed on the table listed on the lower side of this web page.

Port	Schedule
GE1	None
GE2	None
GE3	None
GE4	None
GE5	None
GE6	None
GE7	None
GE8	None

Available settings are explained as follows:

Item	Description
Ports	Select the port or ports for applying the schedule.
Schedule Index	Use the drop down list to choose the schedule profile (from 1 to 15). After clicking Apply , the selected port(s) will be applied with the specified schedule.
Apply	Apply the settings to the switch.

This page is left blank.

Part VIII System Maintenance

VIII-1 TR-069

This device supports TR-069 standard. It is very convenient for an administrator to manage a TR-069 device (e.g., such switch) through an Auto Configuration Server, e.g., VigorACS.

The screenshot displays the 'TR-069 Setting' page in the VigorSwitch web interface. The left sidebar shows a navigation menu with 'System Maintenance' expanded and 'TR-069' selected. The main content area is divided into three sections: 'ACS Settings', 'CPE Settings', and 'TLS Version Settings'.
ACS Settings: Includes a radio button to toggle 'TR-069' between 'Enable' and 'Disable'. Below are input fields for 'URL', 'Username', and 'Password', each with a 'Wizard' button. A 'Last Inform' field shows '(NA)' and a 'Test Inform' button labeled 'Test With Inform'.
CPE Settings: Includes a radio button to toggle 'CPE Client' between 'HTTP' and 'HTTPS'. Below are input fields for 'URL' (pre-filled with 'https://192.168.1.212:8069/cwm/CRN.html'), 'Port' (pre-filled with '8069' and a range '0 - 65535'), 'Username' (pre-filled with 'vigor'), and 'Password' (masked with dots).
TLS Version Settings: This section is partially visible at the bottom of the page.

Available settings are explained as follows:

Item	Description
ACS Settings	<p>TR-069 - Click Enable to activate the settings on this page.</p> <p>URL/Username/Password - Such data must be typed according to the ACS (Auto Configuration Server) you want to link. Please refer to Auto Configuration Server user's manual for detailed information.</p> <p>Wizard - Click it to enter the IP address of VigorACS server, port number and the handler.</p> <p>Last Inform - Display the time that VigorACS server made a response while receiving Inform message from switch last time.</p> <p>Test Inform - Click Test With Inform to send a message based on the event code selection to test if such switch is able to communicate with VigorACS SI server.</p>
CPE Settings	<p>The field lists the authentication information coming from VigorACS server.</p> <p>CPE Client - Specify a protocol (HTTP/HTTPS) for authentication.</p> <p>Port - Sometimes, port conflict might be occurred. To solve such problem, you might change port number for switch. The default number is 8069.</p> <p>Username / Password - Type the username and password that VigorACS can use to access into such switch.</p>
TLS Version Settings	<p>TLS Minimum Protocol Version - Due to security consideration, the built-in HTTPS VPN server of the router had upgraded to TLS1.x protocol. Select one of the versions.</p>
Periodic Inform Settings	<p>Periodic Inform Settings - The default setting is Disable. If enabled, please set interval time or schedule time for the Vigor switch to send notification to CPE. Or click Disable to</p>

	close the mechanism of notification. Interval Time - Enter a value.
STUN Settings	<p>STUN Settings -The default is Disable. If you click Enable, please type the relational settings listed below.</p> <p>Server Address - Enter the IP address of the STUN server.</p> <p>Server Port - Enter the port number of the STUN server.</p> <p>Minimum Keep Alive Period - If STUN is enabled, Vigor switch must send binding request to the server for the purpose of maintaining the binding in the Gateway. Please type a number as the minimum period. The default setting is "60 seconds".</p> <p>Maximum Keep Alive Period - If STUN is enabled, Vigor switch must send binding request to the server for the purpose of maintaining the binding in the Gateway. Please type a number as the maximum period. A value of "-1" indicates that no maximum period is specified. The default setting is "0 second".</p>
Health Check	<p>Vigor system will check the health status of LAN ports including link up /down, speed change or PoE power disconnection.</p> <p>Port Link Up/Down - Select LAN port(s) to do the health check of port link.</p> <p>Link Speed Change - Select LAN port(s) to do the health check of speed change.</p> <p>PoE Port Warning - Select LAN port(s) to do the health check of PoE power.</p>
Apply	Apply the settings to the switch.
Clear	Remove current configuration.

VIII-2 OpenVPN

Devices connecting to VigorSwitch can transmit data to remote end via OpenVPN to ensure the information security.

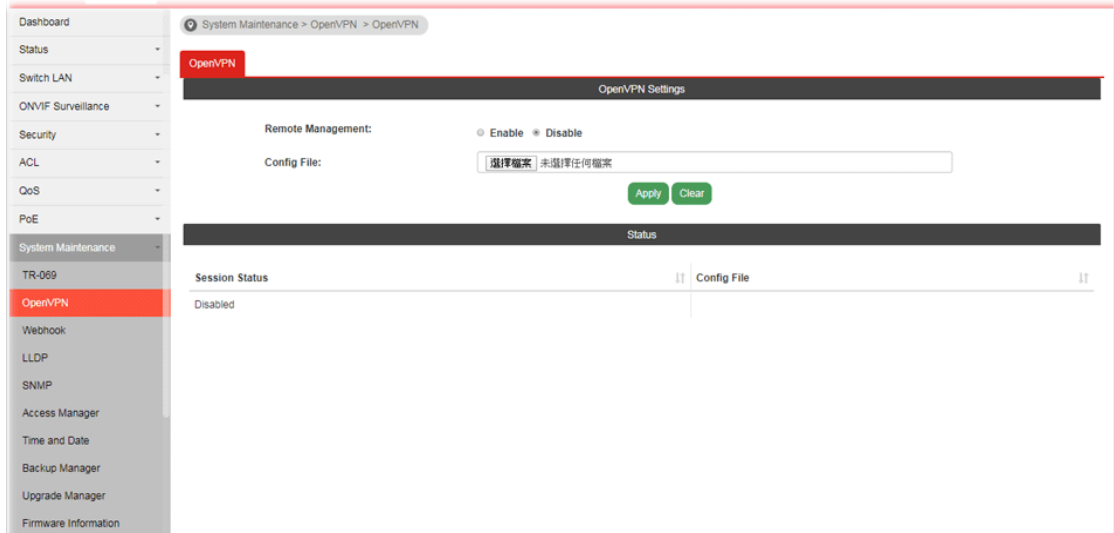

Available settings are explained as follows:

Item	Description
Remote Management	Enable - Click it to enable OpenVPN tunnel between VigorSwitch with the remote end. Disable - Click it to disable OpenVPN tunnel.
Config File	As a VPN client, please import the OpenVPN config file coming from OpenVPN server.
Apply	Save and apply the settings to the switch.
Status	Display current OpenVPN status (Disabled, Connecting or Success) and configuration file used.

VIII-4 LLDP

LLDP is a one-way protocol; there are no request/response sequences. Information is advertised by stations implementing the transmit function, and is received and processed by stations implementing the receive function. The LLDP category contains LLDP and LLDP-MED pages.

VIII-4-1 Properties

This page allows a user to set general settings for LLDP.

The screenshot shows the 'LLDP Global Setting' configuration page. The left sidebar contains a navigation menu with 'LLDP' and 'Properties' highlighted. The main content area has a breadcrumb trail: 'System Maintenance > LLDP > Properties > LLDP Global Setting'. Below this, there's a red header 'LLDP Global Setting'. The settings are as follows:

- LLDP State: Enable Disable
- Transmission Interval: (5-32767)
- Holdtime Multiplier: (2-10)
- Reinitialization Delay: (1-10)
- Transmit Delay: (1-8191)
- LLDP-MED Fast Start Repeat Count: (1-10)
- LLDP MED Network Policy for Voice Application: Auto

An 'Apply' button is located at the bottom left of the settings area.

Available settings are explained as follows:

Item	Description
LLDP State	Enable - Enable LLDP protocol on this switch. Disable - Disable LLDP protocol on this switch.
Transmission Interval	Select the interval at which frames are transmitted. The default is 30 seconds, and the valid range is 5-32768seconds.
Holdtime Multiplier	Select the multiplier on the transmit interval to assign to TTL (range 2-10, default = 4).
Reinitialization Delay	Select the delay before a re-initialization (range 1-10 seconds, default = 2).
Transmit Delay	Select the delay after an LLDP frame is sent (range 1-8192 seconds, default = 3).
LLDP-MED Fast Start Repeat Count	Select the number of LLDP packets that will be sent during LLDP-MED Fast Start period. The default is 3. Available range is from 1 to 10.
LLDP MED Network Policy for Voice Application	Auto - After checking the box, Vigor switch will create an LLDP MED network policy for voice application (e.g, voice signaling, guest voice, softphone voice and etc..) based on the voice VLAN, automatically.
Apply	Apply the settings to the switch.

VIII-4-2 LLDP Port Setting

This page allows a user to select specified port or all ports to configure LLDP state.

Port	State	Selected Optional TLVs	Selected VLAN	Modify
GE1	TX&RX	System Name, Port Description, 802.3 MAC-PHY		✔
GE2	TX&RX	System Name, Port Description, 802.3 MAC-PHY		✔
GE3	TX&RX	System Name, Port Description, 802.3 MAC-PHY		✔
GE4	TX&RX	System Name, Port Description, 802.3 MAC-PHY		✔
GE5	TX&RX	System Name, Port Description, 802.3 MAC-PHY		✔
GE6	TX&RX	System Name, Port Description, 802.3 MAC-PHY		✔
GE7	TX&RX	System Name, Port Description, 802.3 MAC-PHY		✔
GE8	TX&RX	System Name, Port Description, 802.3 MAC-PHY		✔
GE9	TX&RX	System Name, Port Description, 802.3 MAC-PHY		✔

Available settings are explained as follows:

Item	Description
Ports	Use the drop down list to select the port (GE1 to GE12) or ports for device check.
State	<p>Disable - Disable the transmission of LLDP PDUs.</p> <p>TX&RX - Transmit and receive LLDP PDUs both.</p> <p>TX Only - Transmit LLDP PDUs only.</p> <p>RX Only - Receive LLDP PDUs only.</p>
Optional TLVs	<p>Within data communication protocols, optional information may be encoded as a type-length-value or TLV element inside a protocol. TLV is also known as tag-length value.</p> <p>The type and length are fixed in size (typically 1-4 bytes), and the value field is of variable size.</p> <p>Select the LLDP optional TLVs to be carried (multiple selection is allowed).</p> <p>Available items include System Name, Port Description, System Description, System Capability, 802.3 MAC-PHY, 802.3 Link Aggregation, 802.3 Maximum Frame Size, Management Address and 802.1 PVID.</p>
VLAN	Select the VLAN ID number to be performed (multiple selections are allowed).
Apply	Apply the settings to the switch.
Modify	 - Click it to modify the settings for the selected port profile.

VIII-4-3 LLDP Local Device

This page displays information for LLDP Local Device.

Device Summary	
Name	Value
Chassis ID Subtype	MAC Address
Chassis ID	00:1D:AA:00:2B:0A
System Name	P2121
System Description	DrayTek Corp. 8-Port 10/100/1000BaseT PoE + 4-Port 100M/1000M Combo SFP L2 Switch
Capabilities Supported	Bridge
Capabilities Enabled	Bridge
Port ID Subtype	Interface name

Port Details			
Port	LLDP State		Detail
GE1	TX&RX		
GE2	TX&RX		
GE3	TX&RX		
GE4	TX&RX		
GE5	TX&RX		

Available settings are explained as follows:

Item	Description
Device Summary	<p>Display a summary of the LLDP information for this switch.</p> <p>Chassis ID Subtype - Display the type of chassis ID, such as the MAC address.</p> <p>Chassis ID - Display Identifier of chassis. Where the chassis ID subtype is a MAC address, the MAC address of the switch is displayed.</p> <p>System Name - Display model name of switch.</p> <p>System Description - Display description of switch.</p> <p>Capabilities Supported - Display the primary functions of the device, such as Bridge, WLAN AP, or Router.</p> <p>Capabilities Enabled - Primary enabled functions of the device.</p> <p>Port ID Subtype - Display the type of the port identifier that is shown.</p>
Port Details	<p>Display detailed information of the selected GE port.</p> <p> Detail - Click the button under it to review the detailed information contained in TLVs sent out from each interface, containing MAC/PHY, 802.3, 802.3 Link Aggregation, 802.1 VLAN and Protocol for each LAN port (GE1 to GE12).</p>

VIII-4-4 MED Network Policy

This page allows the network administrator to set MED (Media Endpoint Discovery) network policy.

Policy ID	Policy Enabled	Application	VLAN ID	Tagged/Untagged	Priority	DSCP
1	Disabled	Unknown	0	Untagged	0	0
2	Disabled	Unknown	0	Untagged	0	0
3	Disabled	Unknown	0	Untagged	0	0

Available settings are explained as follows:

Item	Description
Policy ID	Choose a number for configuring the policy profile. Available selections include 1 to 32.
Enable Policy	Enable - Click it to enable such function.
Application	There are several applications which can be used for MED network. Selections include Voice Signaling, Guest Voice, Guest Voice Signaling, Softphone Voice, Video Conferencing, Stream Video and Video Signaling.
VLAN	Set a VLAN ID (ranging from 1 to 4095) for such profile.
VLAN Tag	Specify if the outgoing packets will be tagged or not. Untag - Packets will be sent out without any tag. Tag - Packets will be sent out with a number tagged.
Priority	Set Layer2 priority (range from 0 to 7).
DSCP	Set DSCP value (range form 0 to 63).
Apply	Apply the settings to the switch.

VIII-4-5 LLDP MED Port Settings

This page allows the network administrator to configure TLV (Type / Length / Value) settings for each port.

Port	State	TLVs Selected	Policies Selected in Network Policy TLV	Location TLV Settings
GE1	Enabled	Network Policy		
GE2	Enabled	Network Policy		

Available settings are explained as follows:

Item	Description
Ports	Choose the port(s) for configuring TLV settings.
State	Enable - Click it to enable LLDP MED on the selected port.
Available Optional TLV	Available TLV items will be shown in this field. Choose the one(s) you want and click the >> arrow to transfer the selection(s) to the field of "Selected Optional TLV".
Selected Optional TLV	Display the selected TLV items.
Selected Network Policies	Select network policy profiles (created in LLDP>>LLDP MED Network Policy) for applying onto the selected port.
Location TLV Settings	Define the location, civic address and ECS ELIN for LLDP protocol. Coordinate -Enter the coordinate location in 16 pairs of hexadecimal characters. Civic - Enter the civic address in 6 ~ 160 pairs of hexadecimal characters. ECS ELIN - Enter the ECS (Emergency Call Service) ELIN (Emergency Location Identification Number) in 10 ~ 25 pairs of hexadecimal characters.
Apply	Apply the settings to the switch.

VIII-4-6 LLDP Remote Device

This page allows the network administrator to view the information sent from neighboring devices by LLDP protocol.

Local Port	Chassis ID Subtype	Chassis ID	Port ID Subtype	Port ID	System Name	Time to Live	Details	Delete
GE4	MAC address	00:1D:AA:00:0A:63	Locally assigned	gi10	G2280x	94		
GE8	MAC address	00:E0:4C:00:0B:12	Locally assigned	gi6		116		

Available settings are explained as follows:

Item	Description
Local Port	Display the number of the local port to which the neighbor is connected.
Chassis ID Subtype	Display the type of chassis ID (for example, MAC address).
Chassis ID	Display the identifier of the 802 LAN neighboring device's chassis.
Port ID Subtype	Display the type of port identifier.
Port ID	Display the number of port identifier.
System Name	Display the name of the switch.
Time to Live	Display the time interval in seconds after which the information for remote device will be deleted.
Details	Display detailed information contained in TLVs sent out from neighboring devices.
Delete	Click it to remove information of the selected port.

VIII-4-7 LLDP Overloading

This page allows user to review current size, overall size of LLDP packet and whether it is to exceed maximum allowed size of single LLDP packet.

Port	Total(Bytes)	Left to Send(Bytes)	Status	Mandatory TLVs	802.3 TLVs	Optional TLVs	802.1 TLVs
GE1	68	1420	Not Overloading	21(Transmitted)	11(Transmitted)	9(Transmitted)	8(Transmitted)
GE2	68	1420	Not Overloading	21(Transmitted)	11(Transmitted)	9(Transmitted)	8(Transmitted)
GE3	68	1420	Not Overloading	21(Transmitted)	11(Transmitted)	9(Transmitted)	8(Transmitted)
GE4	68	1420	Not Overloading	21(Transmitted)	11(Transmitted)	9(Transmitted)	8(Transmitted)
GE5	68	1420	Not Overloading	21(Transmitted)	11(Transmitted)	9(Transmitted)	8(Transmitted)
GE6	68	1420	Not Overloading	21(Transmitted)	11(Transmitted)	9(Transmitted)	8(Transmitted)
GE7	68	1420	Not Overloading	21(Transmitted)	11(Transmitted)	9(Transmitted)	8(Transmitted)
GE8	68	1420	Not Overloading	21(Transmitted)	11(Transmitted)	9(Transmitted)	8(Transmitted)
GE9	68	1420	Not Overloading	21(Transmitted)	11(Transmitted)	9(Transmitted)	8(Transmitted)
GE10	69	1419	Not Overloading	22(Transmitted)	11(Transmitted)	9(Transmitted)	8(Transmitted)
GE11	69	1419	Not Overloading	22(Transmitted)	11(Transmitted)	9(Transmitted)	8(Transmitted)
GE12	69	1419	Not Overloading	22(Transmitted)	11(Transmitted)	9(Transmitted)	8(Transmitted)

Available settings are explained as follows:

Item	Description
Port	Display the name of the port.
Total(Bytes)	Display the total number of bytes of LLDP information in each packet.
Left to Send(Bytes)	Display the total number of available bytes left for additional LLDP information in each packet.
Status	Display if LLDP TLVs has overloaded the PDU maximum size or not.
Mandatory TLVs	Display how many bytes used by mandatory TLVs.
802.3 TLVs	Display how many bytes used by 802.3 TLVs.
Optional TLVs	Displays how many bytes used by optional TLVs.
802.1 TLVs	Displays how many bytes used by 802.1 TLVs.

VIII-5 SNMP

Simple Network Management Protocol (SNMP) is an "Internet-standard protocol for managing devices on IP networks". Devices that typically support SNMP include routers, switches, servers, workstations, printers, modem racks and more.

SNMP is used mostly in network management systems to monitor network-attached devices for conditions that warrant administrative attention.

SNMP is a component of the Internet Protocol Suite as defined by the Internet Engineering Task Force (IETF). It consists of a set of standards for network management, including an application layer protocol, a database schema, and a set of data objects.

An SNMP-managed network consists of three key components:

- Managed device
- Agent - software which runs on managed devices
- Network management station (NMS) - software which runs on the manager

A managed device is a network node that implements an SNMP interface that allows unidirectional (read-only) or bidirectional (read and write) access to node-specific information. Managed devices exchange node-specific information with the NMSs. Sometimes called network elements, the managed devices can be any type of device, including, but not limited to, routers, access servers, switches, bridges, hubs, IP telephones, IP video cameras, computer hosts, and printers.

An agent is a network-management software module that resides on a managed device. An agent has local knowledge of management information and translates that information to or from an SNMP-specific form.

A network management station (NMS) executes applications that monitor and control managed devices. NMSs provide the bulk of the processing and memory resources required for network management. One or more NMSs may exist on any managed network.

VIII-5-1 View

This page allows the network administrator to create MIB views (Management information base) and then include or exclude OID (Object Identifier) in a view.

The screenshot shows the 'SNMP View' configuration page. On the left is a navigation menu with categories like Dashboard, Status, Switch LAN, ONVIF Surveillance, Security, ACL, QoS, PoE, System Maintenance, and SNMP. The 'SNMP' menu is expanded, showing 'View' as the selected option. The main content area has a breadcrumb 'System Maintenance > SNMP > View > View' and a red 'View' button. Below this is a form with three fields: 'View Name' (text input), 'OID Subtree' (text input), and 'Type' (radio buttons for 'Included' and 'Excluded'). A green 'Add' button is positioned below the form. At the bottom, a table lists existing views.

View	OID Subtree	Type	Delete
all	.1	Included	



Available settings are explained as follows:

Item	Description
View Name	Enter a name of the MIB view.
OID Subtree	Enter an OID string to be included or excluded from the MIB view.
Type	Determine to include or exclude the selected MIBs.
Apply	Apply the settings to the switch.

VIII-5-2 Group

This page allows the network administrator to group SNMP users and assign different authorization and access privileges.

Available settings are explained as follows:

Item	Description
Group Name	Enter a name for the group.
Version	Specify SNMP version.
Security Level	Specify SNMP security level for the group. It is available when SNMPv3 is selected. No Security - No authentication and no encryption. Authentication - Requires authentication but no encryption. Authentication and Privacy -Requires authentication and encryption.
Read View	Enabled - Users of this group have the right to read the selected MIB view. Use the drop down list to select one of the views. The default is "all", which means the group user can read all MIB views.
Write View	Enabled - Users of this group have the right to write the selected MIB view. Use the drop down list to select one of the views. The default is "all", which means the group user can write all MIB views.
Notify View	Enabled - Users of this group have the right to send notification for the selected MIB view. Use the drop down list to select one of the views. The default is "all", which means the group user have the right to send notification for all MIB views.
Add	Click it to create a new group profile.
Edit	 - Click it to modify the settings for the selected group.  - click it to remove the selected group.

VIII-5-3 Community

This page allows a user to add/remove multiple communities of SNMP.



Available settings are explained as follows:

Item	Description
Community Name	Enter a name as community name. The maximum length of the text is limited to 23 characters.
Type	Basic - View and access right can be specified for such SNMP community profile. Advanced - Specify one of the SNMP groups for such SNMP community profile.
View	Simply specify one of the view profiles (created in SNMP>>View) from the drop down list.
Access Right	Read Only - It allows unidirectional access to node-specific information. Read & Write - It allows bidirectional access to node-specific information.
Group	Specify the SNMP group configured by user (SNMP>>Group) to define the object available to the community.
Add	Click it to add a new community.
Edit	Click the icon under Edit to remove the selected community strings.

VIII-5-4 User

This page allows a user to configure SNMPv3 user profile.

Available settings are explained as follows:

Item	Description
User Name	Enter a name for creating new SNMP user.
Group	Choose one of the SNMPv3 group from the drop down list. Then, this user profile will be grouped under the selected SNMP group.
Security Level	Display the security level configured for the selected SNMP group.
Authentication Method	<p>Method - You can change the methods (None, MD5, SHA) for the selected SNMPv3 group. If no method is available for you to select, that means the selected SNMPv3 group is set with No Security.</p> <p>Password - Enter a string as the password for authentication.</p>
Privacy	<p>Method - You can change the methods (None, DES) for the selected SNMPv3 group. If no method is available for you to select, that means the selected SNMPv3 group is set with No Security.</p> <p>Password - Enter a string as the password for authentication.</p>
Add	Click it to add a new user profile.
Edit	<p> - click it to modify the settings for the selected profile.</p> <p> - click it to remove the selected entry.</p>

Edit SNMP User=v3_1_user1

Group:

Security Level: No Auth Auth Auth & Privacy

Authentication Method:

Method None MD5 SHA

Password:

Privacy:

Method: None DES

Password:

However, if there is no SNMPv3 group ready for use, the following pages will appear instead. Refer to VIII-5-2 Group to create a SNMPv3 group first.

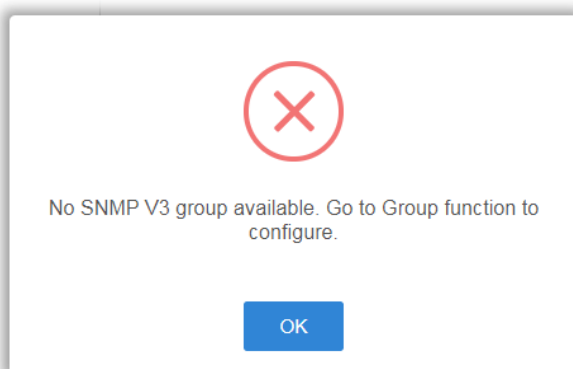

System Maintenance > SNMP > User > Group

SNMP Group

Group Name:

Version: SNMPv1 SNMPv2 SNMPv3

Security Level: No Security Authentication Authentication and Privacy

Read View: Enabled

Write View: Enable

Notify View: Enable

Group Name	Version	Security Level	View (Read)	View (Write)	View (Notify)	Edit
No data available in table						

VIII-5-5 Engine ID

VIII-5-5-1 Local Engine ID

This page allows a user to configure and display SNMP local engine ID.

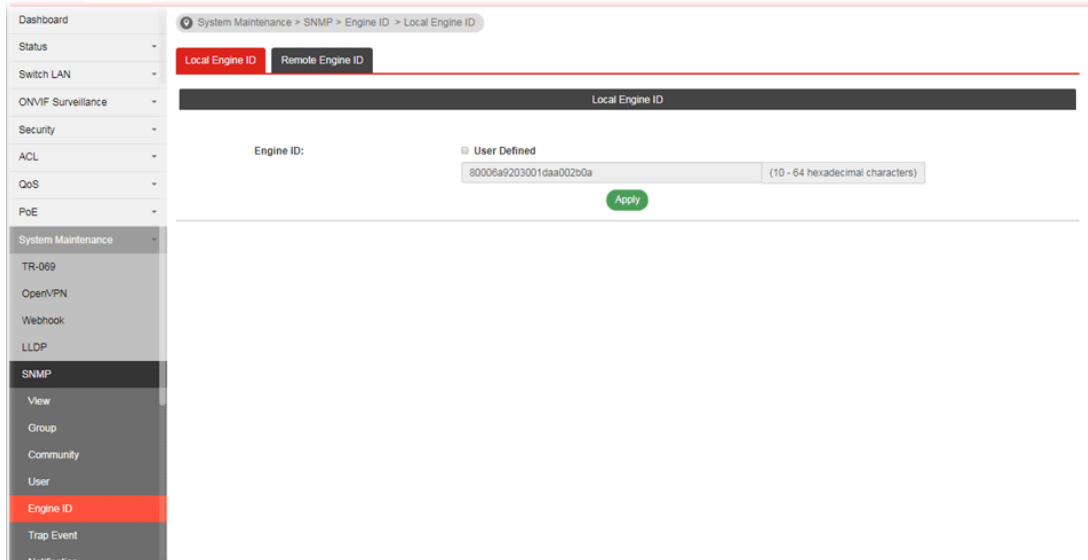



Available settings are explained as follows:

Item	Description
Engine ID	The user defined engine ID is range 10 to 64 hexadecimal characters, and the hexadecimal number must be divided by "2". User Defined - If it is checked, the local engine ID will be configured manually. If not, the default Engine ID which is made up of MAC and Enterprise ID will be used instead.
Apply	Apply the settings to the switch.

VIII-5-5-2 Remote Engine ID

This page allows a user to configure and display SNMP remote engine ID.

Available settings are explained as follows:

Item	Description
Address Type	Specify the address type for entering hostname or IPv4/IPv6 address.
Server Address	Enter the IP address or the host name of the SNMP server.
Engine ID	Specify the engine ID for remote SNMP server. The engine ID is range 10 to 64 hexadecimal characters, and the hexadecimal number must be divided by 2.
Add	Click it to create a new profile.
Edit	 - click it to modify the settings for the selected server profile.  - click it to remove the selected entry.

Edit SNMP Engine ID for

IP=172.16.8.2

Engine ID: (10-64 pairs of hex char)

VIII-5-6 Trap Event

This page allows a user to add or delete SNMP trap receiver IP address and community name.

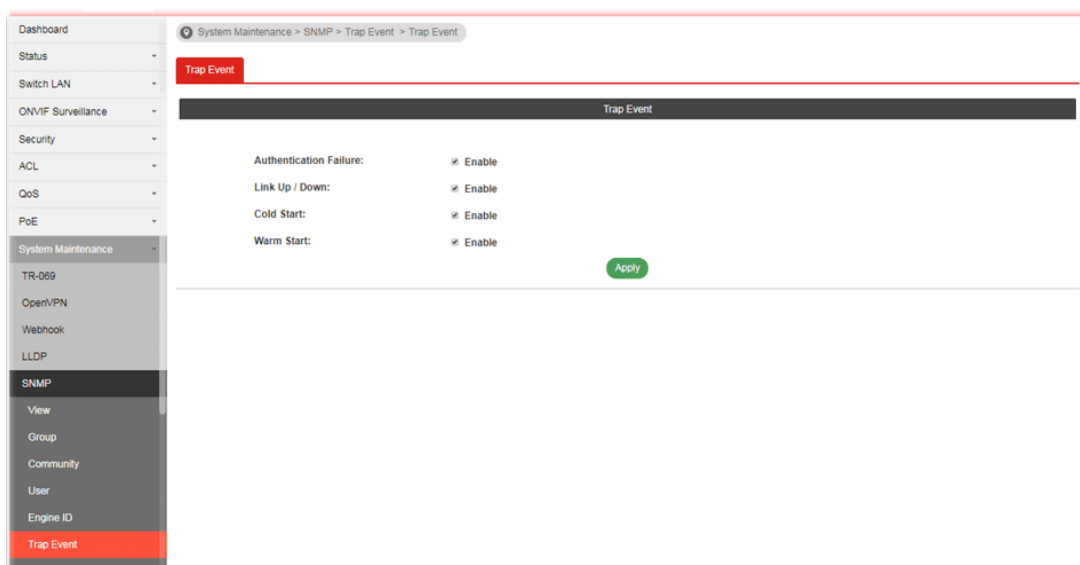

Available settings are explained as follows:

Item	Description
Authentication Failure	Enable - VigorSwitch will reboot when encountering authentication failure (including community not match or user password not match).
Link Up / Down	Enable - VigorSwitch will reboot while encountering port link up or down trap.
Cold Start	Enable - VigorSwitch will reboot while encountering user trap.
Warm Start	Enable - VigorSwitch will reboot while encountering power down trap.
Apply	Apply the settings to the switch.

VIII-5-7 Notification

This page allows a user to configure a host to receive SNMPv1/v2/v3 notification.



The screenshot shows the 'Notification' configuration page. The left sidebar contains a menu with 'SNMP' selected. The main content area has the following fields and options:

- Address Type:** Radio buttons for Hostname, IPv4, and IPv6.
- Server Address:** A text input field.
- Version:** Radio buttons for SNMPv1, SNMPv2, and SNMPv3.
- Type:** Radio buttons for Trap and Inform.
- Community/user:** A dropdown menu with 'public' selected.
- Security Level:** Radio buttons for No Security, Authentication, and Authentication and Privacy.
- Server Port:** A checkbox for 'Use Default' (checked) and a text input field with '162' and '(1 - 65535, default 162)'. A green 'Add' button is below.
- Timeout:** A checkbox for 'Use Default' (checked) and a text input field with '15' and 'sec (1 - 300, default 15)'. A green 'Add' button is below.
- Retry:** A checkbox for 'Use Default' (checked) and a text input field with '3' and '(1 - 255, default 3)'. A green 'Add' button is below.

At the bottom, there is a table with the following columns: Index, Server Address, Server Port, Timeout, Retry, Version, Type, Communication/User, Security Level, and Edit. The table is currently empty with the message 'No data available in table'.

Available settings are explained as follows:

Item	Description
Address Type	Choose IPv4/IPv6/Hostname to specify IP address or the hostname of the SNMP trap recipients.
Server Address	Enter the IP address of SNMP server based on the address type selected above.
Version	Specify SNMP notification version (SNMPv1/v2/v3).
Type	Specify Notification Type. Trap - Send SNMP traps to the host. Inform - Send SNMP informs to the host. If it is used, Timeout and Retry also shall be defined.
Community/user	Use the drop down list to choose one of the community profiles.
Security Level	Specify SNMP security level for SNMP notification packet. It is available when SNMPv3 is selected. No Security - No authentication. Authentication - Authentication without encryption will be performed for packets. Authentication and Privacy - Authentication with encryption will be performed for packets.
Server Port	Specify the UDP port number for the recipient's server. Use Default - If it is checked, the default number (162) will be used automatically.
Timeout	Specify the SNMP informs timeout. It is available when Inform is selected as Type. Use Default - If it is checked, the default number (15) will be used automatically.
Retry	Specify the SNMP informs retry count. It is available when

	<p>Inform is selected as Type. Use Default - If it is checked, the default number (3) will be used automatically.</p>
<p>Add</p>	<p>Click it to create a new notification profile.</p>
<p>Edit</p>	<p> - Click it to modify the settings for the selected server profile.</p> <p> - Click it to remove the selected entry.</p> <div data-bbox="694 539 1417 1361" style="border: 1px solid #ccc; padding: 10px; margin: 10px 0;"> <div style="text-align: right; margin-bottom: 10px;">✕</div> <h3 style="text-align: center; margin: 0;">Edit Notification Entry for Server IP=192.168.1.1</h3> <p>Version: <input type="radio"/> SNMPv1 <input checked="" type="radio"/> SNMPv2 <input type="radio"/> SNMPv3</p> <p>Type: <input checked="" type="radio"/> Trap <input type="radio"/> Inform</p> <p>Community/user <input style="width: 100px; border: 1px solid #ccc;" type="text" value="public"/></p> <p>Security Level: <input checked="" type="radio"/> No Security <input type="radio"/> Auth <input type="radio"/> Privacy</p> <p>Server Port: <input checked="" type="checkbox"/> Use Default <input style="width: 50px; border: 1px solid #ccc;" type="text" value="162"/> (1-65535)</p> <p>Timeout: <input checked="" type="checkbox"/> Use Default <input style="width: 50px; border: 1px solid #ccc;" type="text"/> sec (1-300)</p> <p>Retry: <input checked="" type="checkbox"/> Use Default <input style="width: 50px; border: 1px solid #ccc;" type="text"/> (1-255)</p> <div style="text-align: center; margin-top: 10px;"> <input style="background-color: #007bff; color: white; padding: 5px 15px;" type="button" value="OK"/> <input style="background-color: #6c757d; color: white; padding: 5px 15px;" type="button" value="Cancel"/> </div> </div>

VIII-6 Access Manager

This page allows the network administrator to control availability of management services such as HTTP, HTTPS, Telnet and SSH.

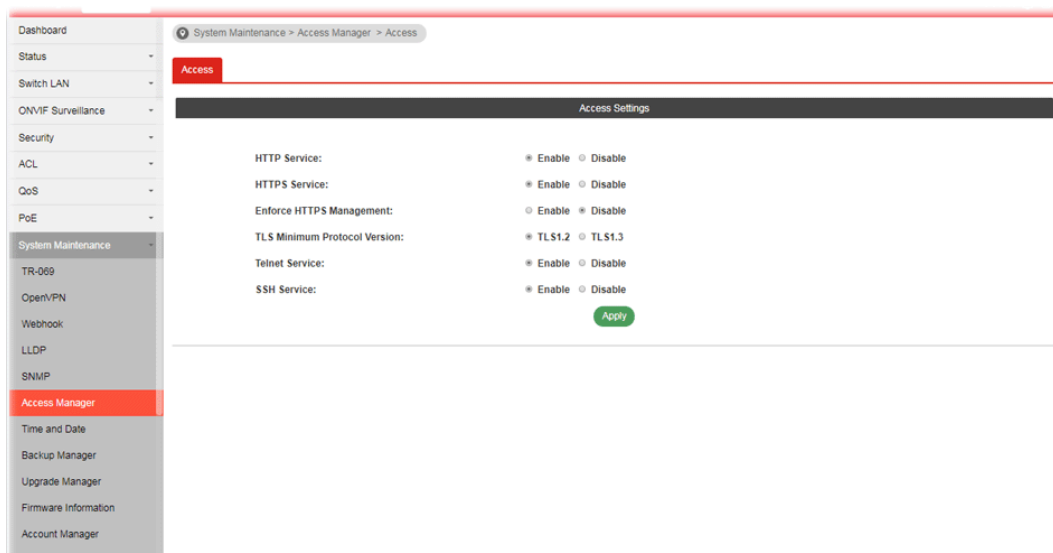

Available settings are explained as follows:

Item	Description
HTTP Service	HTTP is the acronym of HyperText Transfer Protocol. Enabled -Click it to enable HTTP service.
HTTPS Service	HTTPS is the acronym of Hypertext Transfer Protocol over Secure Socket Layer. Enabled - Click it to enable HTTPS service.
Enforce HTTPS Management	Enabled - Users will be forced to access into the web user interface of VigorSwitch by HTTPS protocol.
TLS Minimum Protocol Version	TLS1.2 /TLS 1.3 - VigorSwitch supports TLS1.2 and TLS 1.3 protocols for web browsing. Select one of the versions as a protocol for having higher connection security.
Telnet Service	Telnet is the TCP/IP standard protocol for remote terminal service. TELNET allows a user at one site to interact with a remote timesharing system at another site as if the user's keyboard and display connected directly to the remote machine. Disabled - Click it for not accessing telnet service. Enabled - Click it to access telnet service.
SSH Service	Enabled - Enable SSH service.
Apply	Apply the settings to the switch.

VIII-7 Time and Date

VIII-7-1 System Time Zone

This page allows a user to specify where the time of VigorSwitch should be inquired from.

Available settings are explained as follows:

Item	Description
System Time Zone Setting	
Time Zone	Use the drop down menu to select a time zone that VigorSwitch is located.
Daylight Saving Time	Select the mode of daylight saving time. Disable -Disable daylight saving time. Recurring - Using recurring mode of daylight saving time. Non-Recurring - Using non-recurring mode of daylight saving time. USA -Using daylight saving time in the United States that starts on the second Sunday of March and ends on the first Sunday of November. European - Using daylight saving time in the Europe that starts on the last Sunday.
Daylight Saving Time Offset	It is available when Recurring is selected as Daylight Saving Time. Specify the adjust offset of daylight saving time.
Recurring From / To	It is available when Recurring is selected as Daylight Saving Time. From - Specify the starting time of recurring daylight saving time. To - Specify the ending time of recurring daylight saving time.
Non-recurring From / To	It is available when Non-Recurring is selected as Daylight Saving Time.

	<p>From - Specify the starting time of non-recurring daylight saving time.</p> <p>To - Specify the ending time of recurring daylight saving time.</p>
Apply	Apply the settings to the switch.
System Time Zone Informations	Display the status of system time zone.

VIII-7-2 Time

This page allows a user to specify time and activate SNTP server manually.

The screenshot shows the 'Time' configuration page under 'System Maintenance > Time and Date > Time'. The interface includes a sidebar with navigation options like Dashboard, Status, Switch LAN, ONVIF Surveillance, Security, ACL, QoS, PoE, System Maintenance, and Time and Date. The main content area has the following settings:

- Manual Time:** Year (2000), Month (Jan), Day (2), Hours (15), Minutes (11), Seconds (40).
- Enable SNTP:** * Enable (selected), Disable.
- SNTP/NTP Server Address:** pool.ntp.org (X.X.X.X or Hostname).
- Server Port:** 123 (1 - 65535 | Default : 123).

An 'Apply' button is located below the Server Port field.

Available settings are explained as follows:

Item	Description
Manual Time	Specify static time (year, month, day, hours, minutes and seconds) manually.
Enable SNTP	<p>Enable - Click it to enable SNTP time server.</p> <p>Disable - Click to disable the time server.</p>
SNTP/NTP Server Address	Enter the web site of the time server or the IP address of the server.
Server Port	Enter the port number use by the time server.
Apply	Apply the settings to the switch.

VIII-8 Backup Manager

Backup Manager allows a user to backup the firmware image or configuration file on the switch to remote TFTP server or host file system through HTTP protocol.

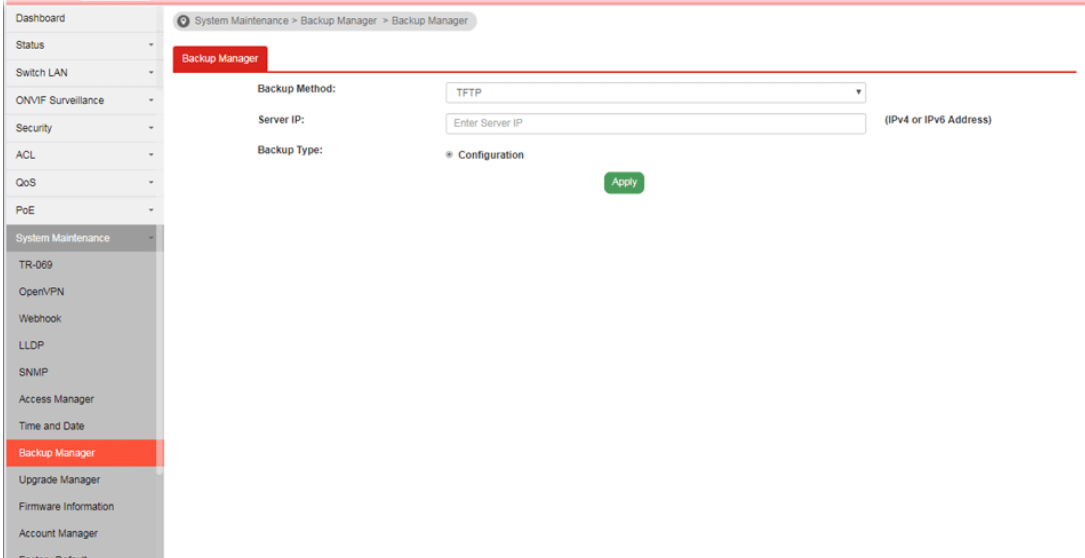

Available settings are explained as follows:

Item	Description
Backup Method	Select Backup method. TFTP - Using TFTP to backup firmware. HTTP - Using WEB browser to ubackup firmware.
Server IP	It is available when TFTP is selected as Backup Method. Enter the IPv4/IPv6 address for the TFTP server.
Backup Type	Configuration - Make a backup copy for the configurations for VigorSwitch.
Apply	Apply the settings to the switch.

VIII-9 Upgrade Manager

Backup Manager allows a user to upgrade the firmware image or configuration file on the switch to remote TFTP server or host file system through HTTP protocol.

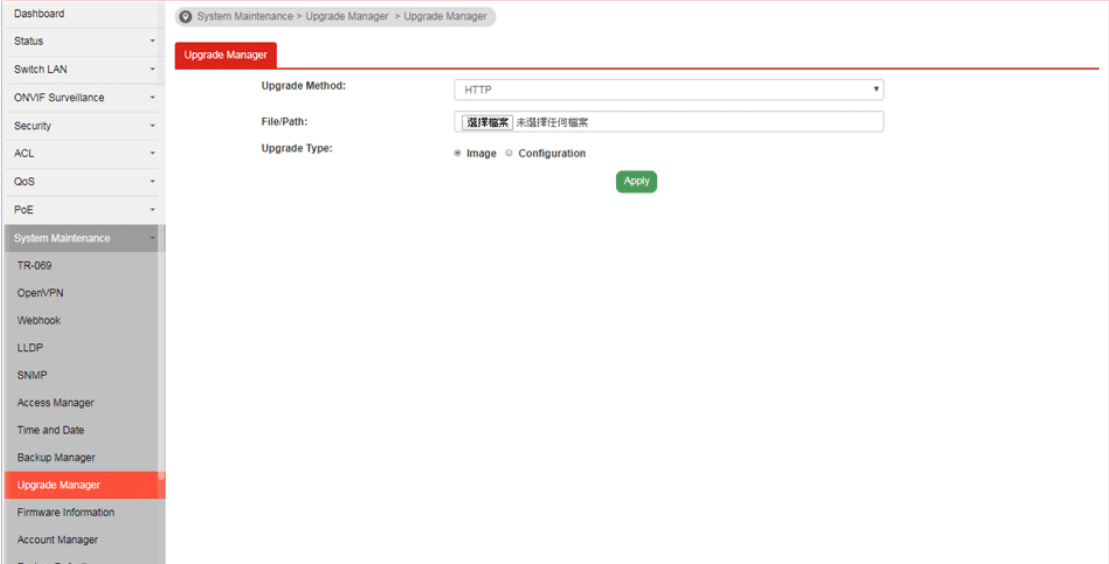

Available settings are explained as follows:

Item	Description
Upgrade Method	Select Upgrade method: TFTP - Using TFTP to upgrade firmware. HTTP - Using WEB browser to upgrade firmware.
Server IP	It is available when TFTP is selected as Upgrade Method. Enter the IPv4/IPv6 address for the TFTP server.
File Name	It is available when TFTP is selected as Upgrade Method. Enter the firmware image or configuration file name on the TFTP server.
File/Path	It is available when HTTP is selected as Upgrade Method. Choose the firmware file located in your computer.
Upgrade Type	It is available when TFTP is selected as Upgrade Method. Image - Click it to upgrade the firmware image. Configuration - Click it to upgrade the configurations for VigorSwitch.
Apply	Apply the settings to the switch.

VIII-10 Firmware Information

This page allows a user to choose the active firmware and backup firmware.

The screenshot shows the 'Firmware Information' page. At the top, there is a breadcrumb trail: 'System Maintenance > Firmware Information > Firmware Information'. Below this is a red header with the text 'Firmware Information'. Underneath the header is a dropdown menu labeled 'Active Image' with 'Firmware 1' selected, and a green 'Apply' button to its right. Below the dropdown are two tables. The first table is titled 'Firmware 1 Information' and has a dark header. It contains one row with the following data: Mode: Backup, Active: --, Version: 2.5.1_RC1, Build Time: 2019-10-01 07:45:02, Size (Byte): 8755828. The second table is titled 'Firmware 2 Information' and also has a dark header. It contains one row with the following data: Mode: Active, Active: v, Version: 2.5.1_RC5, Build Time: 2019-11-28 17:06:13, Size (Byte): 12317690. On the left side of the page is a navigation menu with various options, and 'Firmware Information' is highlighted in red.



Available settings are explained as follows:

Item	Description
Active Image	There are two versions of firmware. Simply choose the one you want as primary firmware.
Apply	Apply the settings to the switch.
Firmware 1 Information Firmware 2 Information	<p>Mode - Display the mode (Active or Backup) of the firmware.</p> <p>Active -Display the status (in use or not) of the firmware.</p> <p>Version - Display the switch version.</p> <p>Build Time - Display the built time of the firmware.</p> <p>Size (MB) - Display the size of the firmware.</p>

VIII-11 Account Manager

This page allows a user to add or delete local user on switch database for authentication. The configuration result for each port will be displayed on the table listed on the lower side of this web page.

Available settings are explained as follows:

Item	Description
User Name	Enter a username for new account. If you want to modify an existed user account, simply enter the same string in this field. Then, modify the password and choose privilege level. After clicking Apply , the existed user name will be modified with different values.
Password	Enter a password for new account.
Password Strength	Display the strength (weak, medium, or strong) of the password entered above.
Retype Password	Retype password to make sure the password is exactly you typed before in "Password" field.
Privilege Level	Use the drop down list to select privilege level (Admin/User) for new account. Admin - Allow to change switch settings. User - See switch settings only. Not allow to change it.
Apply	Apply the settings to the switch.
Delete	Remove the selected account.
Edit	 - Click it to modify the settings for the selected user profile.  - Click it to remove the selected entry.

VIII-12 Factory Default

Click **Apply** to return to factory default settings for VigorSwitch.

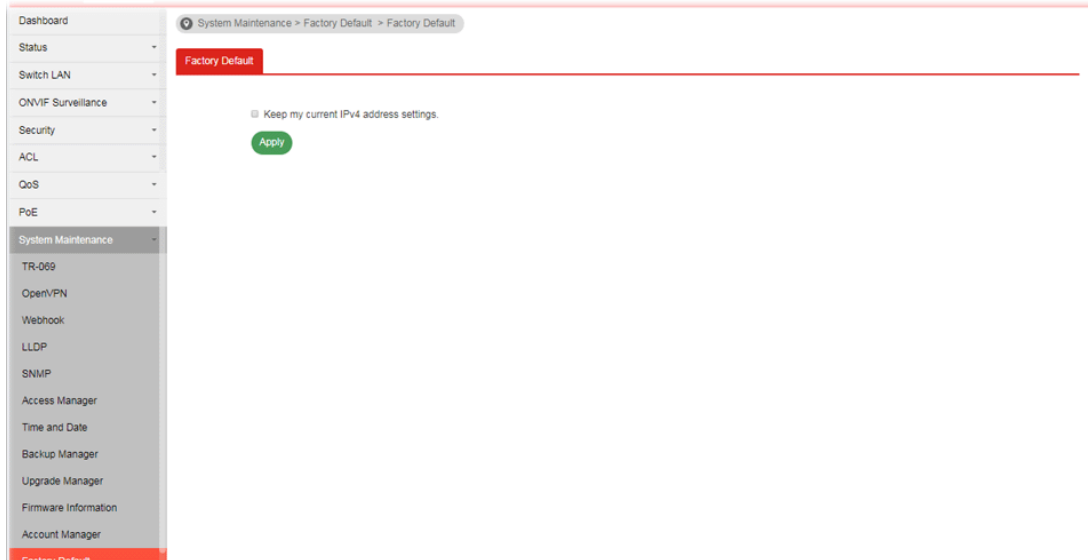

If **Keep my current IPv4 address settings** is checked, after clicking **Apply**, the original configuration for IP address will be kept.

VIII-13 Reboot Switch

Click **Apply** to reboot VigorSwitch with current settings.

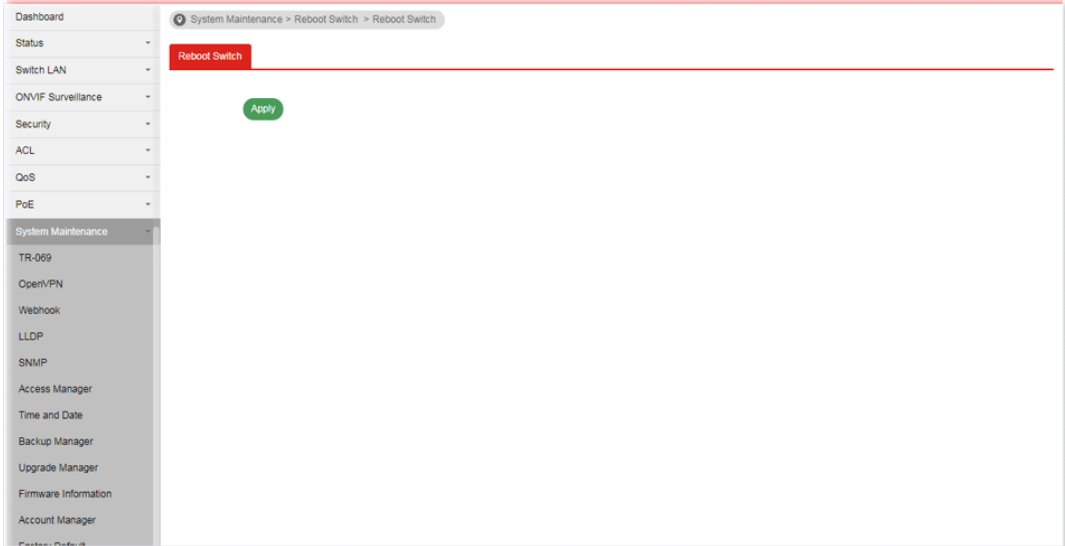

Part IX Diagnostics

IX-1 Device Check

After finished copper test, the results will be shown on the lower side of this web page.

This page is used to configure device check of PoE PD devices. It can be applied to PoE PD devices connected directly, check ping echo status, and forcibly reboot the device when meeting the preset health condition.

The configuration result for each port will be displayed on the table listed on the lower side of this web page.

Port	Enable	Ping IP Addr	Interval Times (s)	Retry Time	Failure Action	Mail Alert
GE1	Disabled	0.0.0.0	15	1	Nothing	Disabled
GE2	Disabled	0.0.0.0	15	1	Nothing	Disabled
GE3	Disabled	0.0.0.0	15	1	Nothing	Disabled
GE4	Disabled	0.0.0.0	15	1	Nothing	Disabled

Available settings are explained as follows:

Item	Description
Port	Use the drop down list to select the port (GE1 to GE12) or ports for device check.
Enable	Disable - No PoE function for the selected GE port. Enable - PoE function will be enabled for the selected GE port.
Ping IP Address	Enter the IP address of the PoE device for check.
Interval Time (sec.)	The ping check will be performed every 10, 30, 60 or 120 seconds for the selected port (PoE device).
Retry Time	The system will perform the ping check the selected port (PoE device) for 1, 3 or 5 times.
Failure Action	Specify the action performed for PoE device when there is no number of retry time of echo from given IP address. Power Cycle - Forcely reboot the device by cycling the power given to PoE device. Power Off - The PoE device will be powered off. Nothing - Log this event only, no action is taken on PoE device.
Mail Alert	Enable - Click it to enable the mail alert function. Disable - Click it to disable the mail alert function.
Apply	Save the settings or changes to the switch.

IX-2 Cable Diagnostics

After finished copper test, the results will be shown on the lower side of this web page.

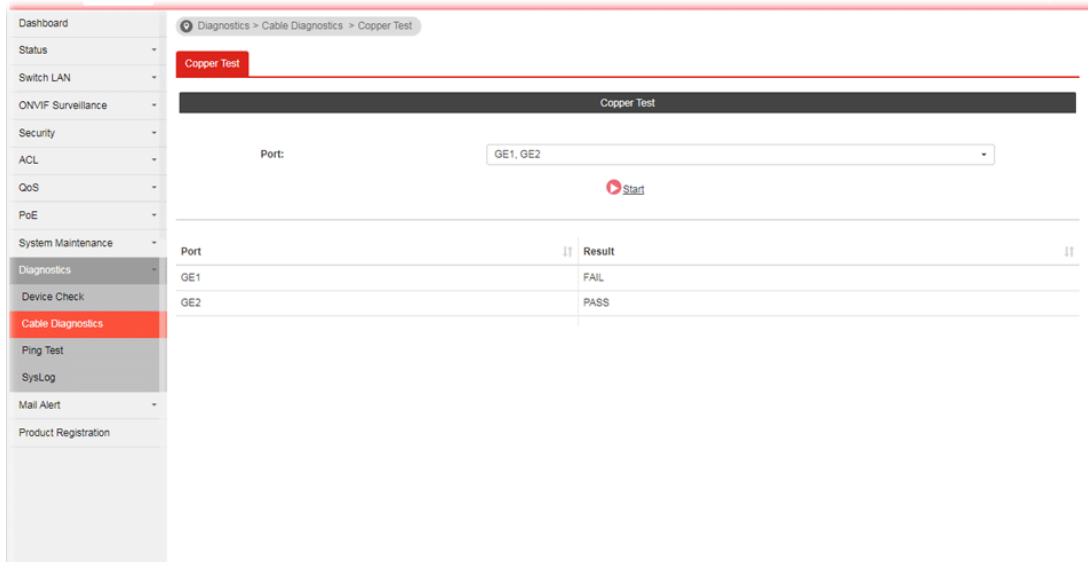

Available settings are explained as follows:

Item	Description
Port	Use the drop down list to select the port (GE1 to GE12) or ports for performing cable diagnostics.
Start	Perform the copper test action.

IX-3 Ping Test

After finished the ping test, the results will be shown on the lower side of this web page.

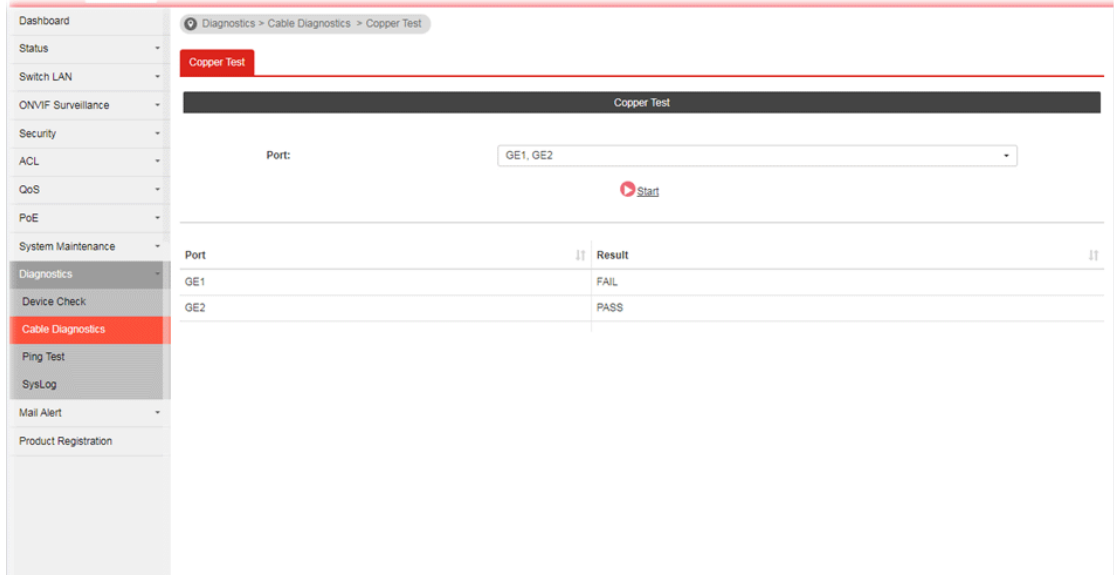

Available settings are explained as follows:

Item	Description
Protocol	Choose IPv4/IPv6 to specify IP address for sending ping to check if network path is ok.
Host	Enter the IP address of SNMP server based on the protocol selected above.
Count	It means how many times to send ping request packet. Enter a number between 1 and 5 as the count and the default configuration is 4.
Interval(sec)	Define the interval to perform ping action. For example, "1" means the ping action will be performed per second.
Start	Perform ping action.
Stop	Terminate ping action.

IX-4 SysLog

IX-4-1 SysLog Explorer

After clicking View, the results will be shown on the lower side of this web page.

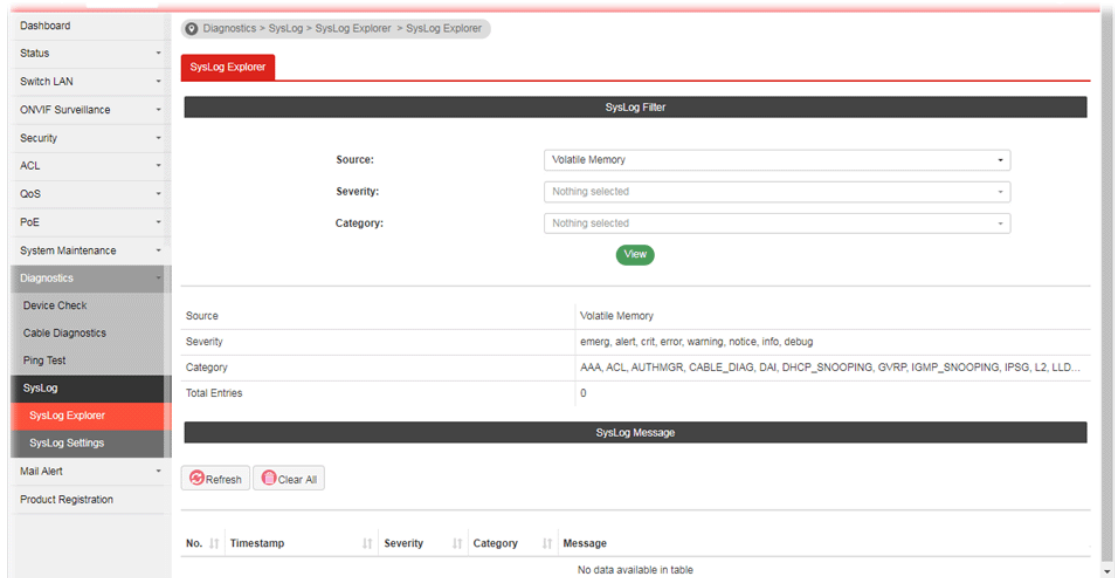

Available settings are explained as follows:

Item	Description
Source	Volatile Memory - Explore the logs contained in volatile memory (also known as RAM). Non-Volatile Memory - Explore the logs contained in non-volatile memory (also known as Flash).
Severity	Select severity (emerg, alert, crit, error, warning, notice, info and debug) of log messages which you wish to filter out for review.
Category	Select the categories (related features) of logs you wish to review. Category contains AAA, ACL, AUTHMGR, CABLE_DIAG, DAI, DHCP_SNOOPING, GVRP, IGMP_SNOOPING, IPSG, L2, LLDP, Mac-based VLAN, Mirror, MLD_SNOOPING, Platform, PM, Port, PORT_SECURITY, QoS, Rate, SNMP, STP, Security suite, System, Surveillance VLAN, Trunk, UDLD and VLAN.
View	Click it to display logs based on the settings configured above.
Refresh	Click it to refresh the log.
Clear All	Clear it to remove all logs displayed in this page.

IX-4-2 SysLog Settings

IX-4-2-1 SysLog Service

This page allows user to enable system logging into local syslog and specific remote syslog server for storage.

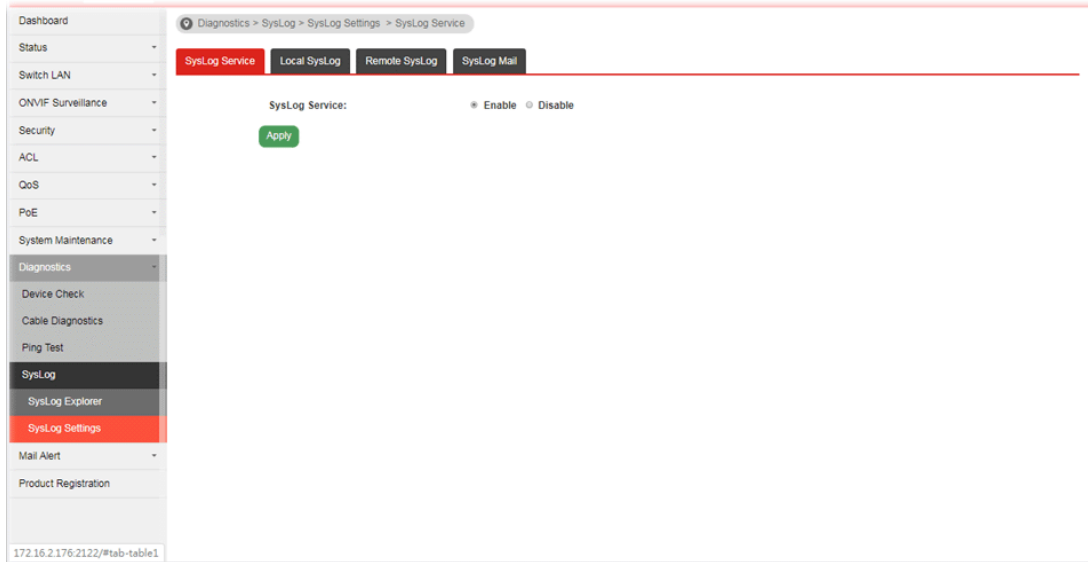

Available settings are explained as follows:

Item	Description
SysLog Service	Enable - Click it to activate function of syslog. Disable - Click it to inactivate the function.
Apply	Apply the settings to the switch.

IX-4-2-2 Local SysLog

This page allows user to enable logging into volatile memory or non-volatile memory.

Available settings are explained as follows:

Item	Description
Source	<p>Volatile Memory - Select the volatile memory for saving local log. Volatile memory does not hold the log after reboot or power off.</p> <p>Non-Volatile Memory - Select the non-volatile memory for saving.</p> <p>If you want to modify Volatile Memory / Non-Volatile Memory, select Volatile Memory / Non-Volatile Memory in this field. Then, use the drop down list of severity to specify type of log message. After clicking Apply, the Volatile Memory / Non-Volatile Memory will be modified with new configured severity level.</p>
Severity	Select severity (emerg, alert, crit, error, warning, notice, info and debug) of log messages which will be stored.
Apply	Apply the settings to the switch.
Delete	Remove all logs displayed in this page.

IX-4-2-3 Remote SysLog

This page allows user to enable system logging into specific remote syslog server for storage. After clicking **Apply**, the results will be shown on the lower side of this web page.

Available settings are explained as follows:

Item	Description
Server Address	Enter the IP address of Syslog server.
Server Port	Specify the port that syslog should be sent to.
Severity	Select severity (emerg, alert, crit, error, warning, notice, info and debug) of log messages which will be stored.
Facility	One device supports multiple facilities (represented with facility ID, local0 to local7) of remote Syslog server. For each facility ID contains different syslog server configuration, please choose a facility ID for such Syslog server.
Apply	Apply the settings to the switch.
Delete	Remove specific remote syslog entry.

IX-4-2-4 SysLog Mail

This page allows user to enable system logging into specific remote syslog server for storage. After clicking **Apply**, the results will be shown on the lower side of this web page.

The screenshot shows the 'SysLog Mail' configuration page. The left sidebar contains a navigation menu with 'SysLog Settings' highlighted. The main content area has tabs for 'SysLog Service', 'Local SysLog', 'Remote SysLog', and 'SysLog Mail'. The configuration fields are as follows:

- State:** Radio buttons for 'Enable' and 'Disable'.
- Category:** A dropdown menu currently showing 'Nothing selected'.
- SMTP Server:** A text input field containing '1.2.3.4 or smtp.example.com'.
- SMTP Port:** A text input field containing '25'.
- Authentication:** Radio buttons for 'Enable' and 'Disable'.
- Encryption:** A dropdown menu currently showing 'Disable'.
- Sender:** A text input field containing 'sender@example.com (Setting may not be applied on some servers)'.
- Email Address:** A text input field containing 'receiver1@example.com,receiver2@example.com,...'.

At the bottom of the configuration area, there are two green buttons: 'Apply' and 'Send test mail'.

Available settings are explained as follows:

Item	Description
State	<p>Enable - Enable the function of Syslog Mail.</p> <p>Disable - Disable the function of Syslog Mail.</p>
Category	<p>Vigor sytem will send the e-mail related to the selected feature(s) to the recipient.</p>
SMTP Server	Enter IP address or URL of the SMTP server.
SMTP Port	Enter the port number for the SMTP server.
Authentication	<p>Enable - Click it to enable authentication mechanism.</p> <ul style="list-style-type: none"> ● Username - Enter a user name for authentication. ● Password - Enter a password for authentication.
Encryption	After enabling Authentication, choose one of the encryption servers for data encryption.

	<ul style="list-style-type: none"> ● StartTLS - The mail will be encrypted with StartTLS. ● SSL/TLS - The mail will be encrypted with SSL/TLS. ● Disable - The mail sent out will not be encrypted.
Sender	Enter the email address which will send the syslog mail out.
Email Address	Enter the email address which will receive the syslog mail.
Apply	Apply the settings to the switch.
Send test mail	After clicking this button, VigorSwitch system will send a test mail to the recipient.

Part X Mail Alert

X-1 Alert Setting

This page allows a user to configure settings for VigorSwitch to send alert mail when encountering certain situation.

Available settings are explained as follows:

Item	Description
State	<ul style="list-style-type: none"> ● Enable - Click it to enable the mail alert function. ● Disable - Click it to disable the mail alert function.
SMTP Server	Enter IP address or URL of the SMTP server.
SMTP Port	Enter the port number for the SMTP server.
Authentication	Enable - Click it to enable authentication mechanism. <ul style="list-style-type: none"> ● User Name - Enter a user name for authentication. ● Password - Enter a password for authentication.
Encryption	After enabling Authentication, choose one of the encryption servers for data encryption. <ul style="list-style-type: none"> ● StartTLS - The mail will be encrypted with StartTLS. ● SSL/TLS - The mail will be encrypted with SSL/TLS. ● Disable - The mail sent out will not be encrypted.
Sender	Enter the email address which will send the alert mail out.
Receiver	Enter the email address which will receive the alert mail.
Min. Transmit Interval	Set a time interval for VigorSwitch system to send an alert out from the specified sender.
Alert Type	Specify the condition(s) for VigorSwitch system to send an alert out. <ul style="list-style-type: none"> ● Port Link Status ● Port Link Speed ● System Restarted ● PoE Warning Status ● IP Conflict

	<ul style="list-style-type: none">● Device Check● ONVIF Throughput Threshold
Apply	Apply the settings to the switch.
Send test mail	After clicking this button, VigorSwitch system will send a test mail to the recipient.

This page is left blank,

Part XI Telnet Commands

XI-1 Accessing Telnet of VigorSwitch

This chapter also gives you a general description for accessing telnet and describes the firmware versions for the routers explained in this manual.



Info

For Windows 7 user, please make sure the Windows Features of Telnet Client has been turned on under Control Panel>>Programs.

Type cmd and press Enter. The Telnet terminal will be open later.

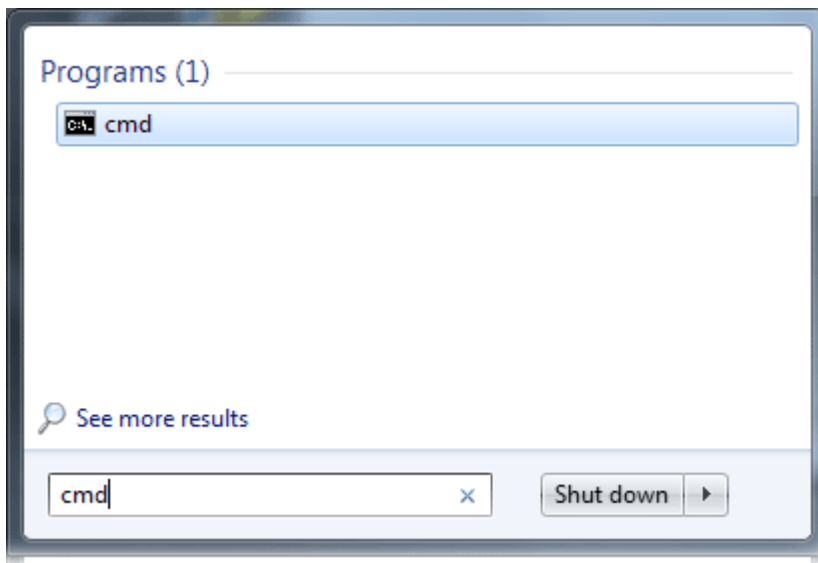

In the following window, type Telnet 192.168.1.224 as below and press Enter. Note that the IP address in the example is the default address of the router. If you have changed the default, enter the current IP address of the router.

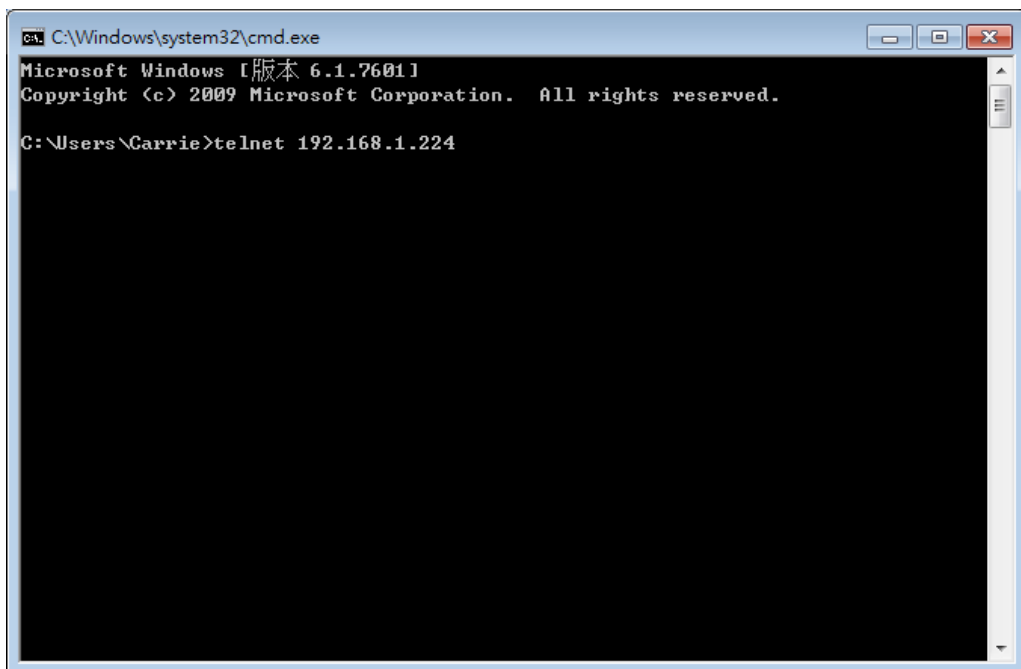

Next, enter admin/admin for Account/Password.

For users using previous Windows system (e.g., XP), simply click **Start >> Run** and type **Telnet 192.168.1.224** in the Open box.

Next, enter **admin/admin** for **Account/Password**.

XI-2 Available Commands

Enter ? to get a list of available commands.

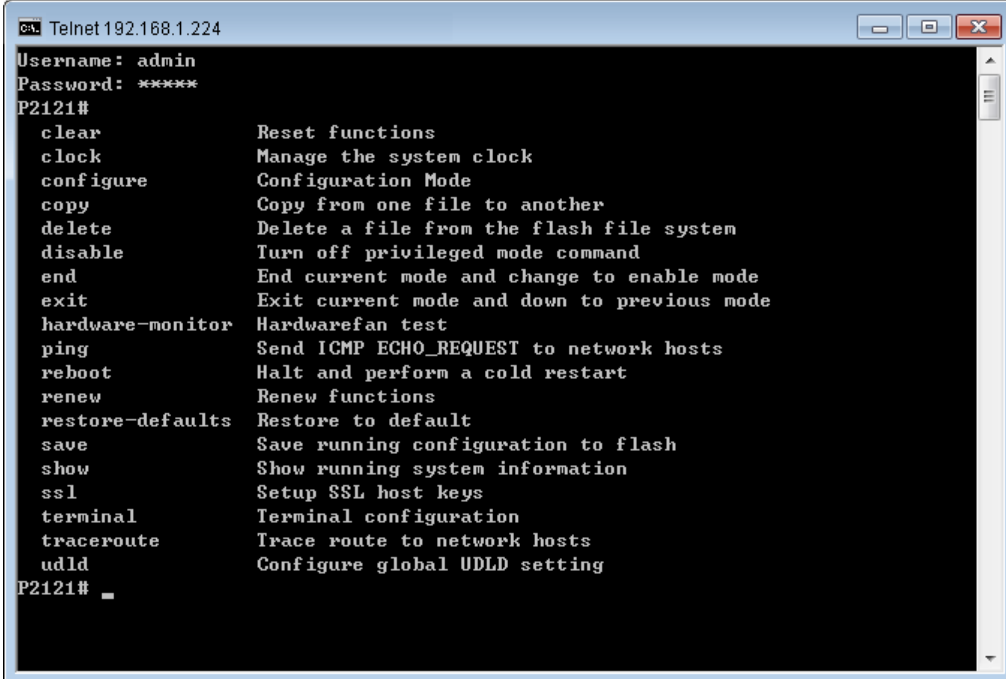

```
ca: Telnet 192.168.1.224
Username: admin
Password: *****
P2121#
clear          Reset functions
clock         Manage the system clock
configure     Configuration Mode
copy         Copy from one file to another
delete       Delete a file from the flash file system
disable      Turn off privileged mode command
end          End current mode and change to enable mode
exit        Exit current mode and down to previous mode
hardware-monitor Hardwarefan test
ping        Send ICMP ECHO_REQUEST to network hosts
reboot      Halt and perform a cold restart
renew       Renew functions
restore-defaults Restore to default
save        Save running configuration to flash
show        Show running system information
ssl         Setup SSL host keys
terminal    Terminal configuration
traceroute  Trace route to network hosts
udld        Configure global UDLD setting
P2121# _
```

The available commands contain – clear, clock, configure, copy, delete, disable, end, exit, hardware-monitor, ping, reboot, renew, restore-defaults, save, show, ssl, terminal, traceroute and udld. Each command will be explained as follows.

Note: You can also enter ? to check if there are subcommands under current command.

XI-2-1 Clear Configuration

This command allows resetting the functions of ARP, authentication, gvrp, interfaces, IP, IPv6, LACP, Line, LLDP, Logging, MAC, mvr, and Spanning Tree.

Telnet Command: clear arp

Use this command to clear entries in the ARP cache.

Syntax Items

clear arp

Description

Syntax Items	Description
<i>clear arp</i>	<A.B.C.D> - Enter the IP address of the device (e.g., 192.168.1.224). Related Syntax: <ul style="list-style-type: none">● # clear arp● # clear arp <A.B.C.D>

Example

```
P2121# clear arp 192.168.1.224
P2121#
```

Telnet Command: clear authentication

Use this command to clear authentication sessions based on LAN port, MAC address, or authentication type for 802.1x/MAC authentication.

Syntax Items

clear authentication sessions

clear authentication sessions interfaces gigabitethernet

clear authentication sessions mac

clear authentication sessions session-id

clear authentication sessions type

Description

Syntax Items	Description
<i>clear authentication sessions</i>	Clear all of the sessions related to authentication. Related Syntax: <ul style="list-style-type: none">● # clear authentication sessions
<i>clear authentication sessions interfaces gigabitethernet</i>	Clear the sessions of a specific interface. <1-12> - Enter the number of LAN port. Related Syntax: <ul style="list-style-type: none">● # clear authentication sessions interfaces gigabitethernet <1-12>
<i>clear authentication sessions mac</i>	Clear the sessions with the MAC address set here. <A:B:C:D:E:F> - Enter the MAC address of the device that you want to clear the authentication information. Related Syntax: <ul style="list-style-type: none">● # clear authentication sessions mac <A:B:C:D:E:F>
<i>clear authentication sessions session-id</i>	Clear the sessions with the string set here. <WORD> - Enter a string of a session that you want to clear. Related Syntax: <ul style="list-style-type: none">● # clear authentication sessions session-id <WORD>
<i>clear authentication sessions type</i>	Clear the sessions with authentication type selected here. <dot1x> - Use 802.1x authentication. <mac> - Use mac-based authentication. <web> - Use web-based authentication. Related Syntax: <ul style="list-style-type: none">● # clear authentication sessions type <dot1x><mac><web>

Example

```
P2121# clear authentication sessions
No Auth Manager sessions currently exist
P2121# clear authentication sessions mac 48:5B:39:2F:A8:66
```

```
P2121# clear authentication sessions interfaces GigabitEthernet 2
P2121# clear authentication sessions session-id 0000000B002AFBE8
```

Telnet Command: clear gvrp

Use this command to clear statistics or port error statistics for all interfaces or a specific interface (LAN or LAG).

Syntax Items

clear gvrp error-statistics

clear gvrp statistics

Description

Syntax Items	Description
<i>clear gvrp error-statistics</i>	<p>Specify a LAN/LAG interface for clearing error statistics for GVRP.</p> <p><1-12> - Enter the number (1 to 12) of LAN port.</p> <p><1-8> - Enter the number (1 to 8) of LAG interface (IEEE 802.3 Link Aggregation Interface) that you want to clear the GVRP setting.</p> <p>Related Syntax:</p> <ul style="list-style-type: none"> ● # clear gvrp error-statistics interfaces GigabitEthernet <1-12> ● # clear gvrp error-statistics interfaces LAG <1-8>
<i>clear gvrp statistics</i>	<p>Specify a LAN/LAG interface for clearing statistics for GVRP.</p> <p><1-12> - Specify an interface for clearing statistics for GVRP.</p> <p><1-8> - Specify LAG interface for clearing statistics for GVRP.</p> <p>Related Syntax:</p> <ul style="list-style-type: none"> ● # clear statistics interfaces GigabitEthernet <1-12> ● # clear statistics interfaces LAG <1- 8>

Example

```
P2121# clear gvrp error-statistics interfaces GigabitEthernet 2
P2121#
P2121# clear gvrp error-statistics interfaces LAG 2
P2121#
```

Telnet Command: clear interfaces

Use this command to clear statistics counters for all interfaces or a specific interface (LAN or LAG).

Syntax Items

clear interfaces GigabitEthernet

clear interfaces LAG

Description

Syntax Items	Description
<i>clear interfaces GigabitEthernet</i>	Specify a LAN interface for clearing statistics counters on that port. <1-12> - Enter the number (1 to 12) of LAN port. Related Syntax: <ul style="list-style-type: none">● # clear interfaces gigabitEthernet <1-12> counters
<i>clear interfaces LAG</i>	Specify a LAG interface for clearing statistics counters on that port. <1-8> - Enter the number (1 to 8) of LAG interface (IEEE 802.3 Link Aggregation Interface). Related Syntax: <ul style="list-style-type: none">● # clear interfaces LAG <1-8> counters

Example

```
P2121# clear interfaces gigabitEthernet 3 counters
P2121# clear interfaces
P2121# clear interfaces lag 2 counters
P2121#
```

Telnet Command: clear ip

Use this command to clear ARP inspection information, DHCP snooping database agent, and IGMP snooping groups (dynamic or static) information for all interfaces or a specific interface (LAN or LAG) with IP address.

Syntax Items

clear ip arp

clear ip dhcp

clear ip igmp

Description

Syntax Items	Description
<i>clear ip igmp</i>	snooping groups dynamic - Clear dynamic snooping groups of IGMP server. snooping groups static - Clear static snooping groups of IGMP server. snooping statistics - Clear snooping statistics for IGMP server. Related Syntax: <ul style="list-style-type: none">● # clear ip igmp snooping groups dynamic● # clear ip igmp snooping groups static● # clear ip igmp snooping statistics
<i>clear ip dhcp</i>	snooping database statistics - Clear snooping database statistics for

	<p>DHCP server.</p> <p>snooping interfaces GigabitEthernet / LAG- Specify a LAN / LAG interface for clearing DHCP snooping information.</p> <p><1-12> - Enter the number (1 to 12) of LAN port.</p> <p><1-8> - Specify a LAG interface for clearing DHCP snooping information.</p> <p>Related Syntax:</p> <ul style="list-style-type: none"> ● # clear ip dhcp snooping database statistics ● # clear ip dhcp snooping interfaces GigabitEthernet <1-12> statistics ● # clear ip dhcp snooping interfaces LAG <1-8> statistics
<i>clear ip igmp</i>	<p>snooping groups dynamic - Clear dynamic snooping groups of IGMP server.</p> <p>snooping groups static - Clear static snooping groups of IGMP server.</p> <p>snooping statistics - Clear snooping statistics for IGMP server.</p> <p>Related Syntax:</p> <ul style="list-style-type: none"> ● # clear ip igmp snooping groups dynamic ● # clear ip igmp snooping groups static ● # clear ip igmp snooping statistics

Example

```
P2121# clear ip igmp snooping groups dynamic
P2121#
```

Telnet Command: clear ipv6

Use this command to clear MLD snooping configuration for dynamic / static group(s) with IPv6 address.

Syntax Items

clear ipv6 mld

Description

Syntax Items	Description
<i>clear ipv6 mld</i>	<p>snooping groups dynamic - Clear dynamic snooping groups of MLD.</p> <p>snooping groups static - Clear static snooping groups of MLD.</p> <p>Related Syntax:</p> <ul style="list-style-type: none"> ● # clear ipv6 mld snooping groups dynamic ● # clear ipv6 mld snooping groups static ● # clear ipv6 mld snooping statistics

Example

```
P2121# clear ipv6
P2121# clear ipv6 mld snooping groups dynamic
P2121# clear ipv6 mld snooping groups dynamic?
<cr>
P2121# clear ipv6 mld snooping groups static
```

Telnet Command: clear lacp

Use this command to clear LACP configuration for specified LAG interface or all LAG interfaces.

Syntax Items

`clear lacp <1-8> counters`

`clear lacp counters`

Description

Syntax Items	Description
<code>clear lacp <1-8></code>	<1-8> - Enter the number (1 to 8) of LAG interface (IEEE 802.3 Link Aggregation Interface). Related Syntax: <ul style="list-style-type: none">● # clear lacp <1-8> counters
<code>clear lacp counters</code>	Clear LACP configuration for all LAG interfaces. Related Syntax: <ul style="list-style-type: none">● # clear lacp counters

Example

```
P2121# clear lacp 1 counters
No interfaces configured in the channel group
P2121#
```

Telnet Command: clear line

Use this command to clear line settings including SSH (Secure Shell) configuration and telnet daemon configuration.

Syntax Items

`clear line ssh`

`clear line telnet`

Description

Syntax Items	Description
<code>clear line ssh</code>	Clear SSH configuration for line connection. Related Syntax: <ul style="list-style-type: none">● # clear line ssh
<code>clear line telnet</code>	Clear SSH Telnet configuration for line connection. Related Syntax: <ul style="list-style-type: none">● # clear line telnet

Example

```
P2121# clear line ssh
```

```
P2121# clear line telnet
```

Telnet Command: clear lldp

Use this command to clear LLDP statistics or reset LLDP information.

Syntax Items

clear lldp global

clear lldp interfaces

Description

Syntax Items	Description
<i>clear lldp global</i>	Clear all of the statistics related to LLDP. Related Syntax: <ul style="list-style-type: none">● # clear lldp global statistics
<i>clear lldp interfaces</i>	Specify a LAN / LAG interface for clearing LLDP information. <1-12> - Enter the number (1 to 12) of LAN port. <1-8> - Enter the number (1 to 8) of LAG interface (IEEE 802.3 Link Aggregation Interface). Related Syntax: <ul style="list-style-type: none">● # clear lldp interfaces GigabitEthernet <1-12> statistics● # clear lldp interfaces LAG <1-8> statistics

Example

```
P2121# clear lldp global statistics
P2121#
P2121# clear lldp interfaces LAG 1 statistics
P2121# clear lldp interfaces gigabitethernet 1 statistics
P2121#
```

Telnet Command: clear logging

Use this command to clear log messages from the internal logging buffer and flash.

Syntax Items

clear logging buffered

clear logging file

Description

Syntax Items	Description
<i>clear logging buffered</i>	Clear the log stored in RAM. Related Syntax: <ul style="list-style-type: none">● # clear logging buffered
<i>clear logging file</i>	Clear the log stored in flash. Related Syntax: <ul style="list-style-type: none">● # clear logging file

Example

```
P2121# clear logging buffered
P2121# clear logging file
P2121#
```

Telnet Command: clear mac

Use this command to clear MAC configuration related to VLAN, LAG, and LAN port.

Syntax Items

clear mac

Description

Syntax Items	Description
<i>clear mac address-table</i>	<1-12> - Enter the number (1 to 12) of LAN port. <1-8>- Enter the number (1 to 8) of LAG interface (IEEE 802.3 Link Aggregation Interface). <1-4094> - Specify a VLAN ID by entering its number. Related Syntax: <ul style="list-style-type: none">● # clear mac address-table dynamic interfaces GigabitEthernet <1-12>● # clear mac address-table dynamic interfaces LAG <1-8>● # clear mac address-table dynamic vlan <1-4094>

Example

```
P2121# clear mac address-table dynamic vlan 2038
P2121# clear mac address-table dynamic interfaces gigabitethernet 3
P2121#
```

Telnet Command: clear mvr

Use this command to clear information for all members (including dynamic, static) of MVR.

Syntax Items

clear mvr members

Description

Syntax Items	Description
<i>clear mvr members</i>	Clear information for dynamic / static members. Related Syntax: <ul style="list-style-type: none">● # clear mvr members dynamic● # clear mvr members static

Example

```
P2121# clear mvr members dynamic
P2121# clear mvr members static
P2121#
```

Telnet Command: clear spanning-tree

Use this command to clear running system information.

Syntax Items

clear spanning-tree

Description

Syntax Items	Description
<i>clear spanning-tree interfaces</i>	<p>Specify a LAN interface for clearing its running information.</p> <p><1-12>- Enter the number (1 to 12) of LAN port.</p> <p><1-8>- Enter the number (1 to 8) of LAG interface (IEEE 802.3 Link Aggregation Interface).</p> <p>Related Syntax:</p> <ul style="list-style-type: none">● # clear spanning-tree interfaces GigabitEthernet <1-12> statistics● # clear spanning-tree interfaces LAG <1-8> statistics

Example

```
P2121# clear spanning-tree interfaces GigabitEthernet
<1-12> GigabitEthernet device number
P2121# clear spanning-tree interfaces gigabitethernet 3 statistics
P2121# clear spanning-tree interfaces LAG 1 statistics
P2121#
```

XI-2-2 Clock Configuration

This command allows managing the system clock.

Telnet Command: clock set

Use this command to configure the system clock manually.

Syntax Items

clock set

Description

Syntax Items	Description
<i>clock set</i>	<p>Set current by entering hours, minutes, seconds, month, date and year with the format listed below:</p> <p><HH:MM:SS> - Hour, minute, second (e.g., 08:10:30).</p> <p><Jan> - January.</p> <p><feb> - February</p> <p><mar> - March</p> <p><apr> - April</p> <p><may> - May</p> <p><jun> - June</p> <p><jul> - July</p> <p><aug> - August</p> <p><sep> - September</p> <p><oct> - October</p> <p><nov> - November</p> <p><dec> - December</p> <p><1-31> - Date 1 to 31.</p> <p><2000-2035> - Year of 2000 to 2035.</p> <p>Related Syntax:</p> <ul style="list-style-type: none">● # clock set HH:MM:SS jan/feb/mar/apr/may/jun/jul/aug/sep/oct/nov/dec <1-31> <2000-2035>

Example

```
P2121# clock set 12:10:30 jan 1 2019
2019-01-01 12:10:30 UTC+8
```

XI-2-3 Configure Configuration

This command allows configuring the settings related to VigorSwitch.

Available sub-commands under Configure include:

aaa, authentication, boot, clock, custom, dos, dot1x, do, dray_surveillance, enable, end, errdisable, exit, gvrp, hostname, interface, ip, ipv6, jumbo-frame, lacp, lag, line, lldp, logging, logmail, loop-protection, mac, mailalert, management, management-vlan, mirror, mvr, no, openvpn, poe, port-security, qos, radius, schedule, snmp, sntp, spanning-tree, start-up, storm-control, surveillance-vlan, system, tacacs, tr069, udd, username, vlan, voice-vlan, webhook

Before configuration, you have to enter "configure" to access into next phase.

To return to previous phase, enter "exit"

Example

```
P2121# configure
P2121(config)#
P2121(config)# exit
P2121#
```

Telnet Command: aaa

Use this command to add a login authentication list to authenticate with local, tacacs+, radius, and none service.

Syntax Items

aaa authentication enable

aaa authentication login

Description

Syntax Items	Description
<i>aaa authentication enable</i>	<p>Enable authentication is used only on CLI for a user trying to switch from User EXEC (>) mode to Privileged EXEC (#) mode.</p> <p>enable - Enable the authentication list.</p> <p><LISTNAME> - Enter a string as the list name for authentication type. Default value is "default".</p> <p><none, enable, tacacs+, radius> - Specify the authentication method by entering none, enable, tacacs+ or radius.</p> <ul style="list-style-type: none">● None: Do nothing and just make user be authenticated.● Enable: Use local password to authenticate.● Tacacs+: Use remote Tacas+ server to authenticate.● Radius: Use remote Radius server to authenticate. <p>default - It is used to configure default enable authentication.</p> <p>Related Syntax:</p> <ul style="list-style-type: none">● <config>#aaa authentication enable <LISTNAME> <none, enable, tacacs+, radius>● <config>#aaa authentication enable default <none, enable, tacacs+, radius>
<i>aaa authentication login</i>	<p>Login authentication is used when a user tries to login into the switch.</p> <p><LISTNAME> - Enter a string as the list name for authentication type. Default value is "default".</p>

	<p><none, enable, tacacs+, radius> -Specify the authentication method by entering none, enable, tacacs+ or radius.</p> <p>default - It is used to configure default login authentication.</p> <p>Related Syntax:</p> <ul style="list-style-type: none"> ● <config>#aaa authentication login <LISTNAME> <none, enable, tacacs+, radius> ● <config>#aaa authentication login default <none, enable, tacacs+, radius>
--	---

Example

```

P2121# configure
P2121(config)#
P2121(config)# aaa authentication enable LISTNAME enable
P2121(config)#
P2121(config)# exit
P2121# show aaa authentication enable lists
  Enable List Name   Authentication Method List
-----
                default           enable
                LISTNAME          enable
P2121#

```

Telnet Command: authentication

Use this command to enable the global setting of 802.1x/MAC/WEB authentication network access control (default is disabled for all).

Syntax Items

authentication dot1x

authentication guest-vlan

authentication mac

authentication web

Description

Syntax Items	Description
<i>authentication dot1x</i>	<p>Enable 802.1x authentication by entering the word, dot1x after authentication.</p> <p>Related Syntax:</p> <ul style="list-style-type: none"> ● <config># authentication dot1x
<i>authentication guest-vlan</i>	<p>Configure the guest VLAN.</p> <p><1-4094> - Specify a guest VLAN ID by entering its number.</p> <p>Related Syntax:</p> <ul style="list-style-type: none"> ● <config># authentication guest-vlan <1-4094>
<i>authentication mac</i>	<p>Enable MAC authentication by entering the word, mac after authentication.</p> <p>mac local - Local database for MAC-Based authentication. It can add local MAC authentication hosts in database.</p> <p><A:B:C:D:E:F> - Enter the MAC address to be added for authentication.</p> <p>control auth - Set a local entry control mode, auth (the host will be set to authorized) or unauth (the host will be set to unauthorized).</p> <p>vlan <1-4094> - Specify a VLAN ID by entering its number</p>

	<p>reauth-period <300-4294967294> - Set a time to initiate automatic re-authentication.</p> <p>inactive-timeout <60-65535>- Set the inactive timeout for MAC authentication host. After the time interval, if there is no activity from the client, then it will be unauthorized by Vigor system.</p> <p>control unauth - Set a local entry control mode as "unauth" to let the host set as unauthorized.</p> <p>radius mac-case <lower / upper> - Set RADIUS user ID with lower case or upper case.</p> <p>radius mac-delimiter <colon/dot/hyphen/none> - Select RADIUS user ID delimiter. In which,</p> <p style="padding-left: 40px;">colon: XX:XX:XX:XX:XX:XX</p> <p style="padding-left: 40px;">dot: XX.XX.XX.XX.XX.XX</p> <p style="padding-left: 40px;">hyphen: XX-XX-XX-XX-XX-XX</p> <p style="padding-left: 40px;">none: XXXXXXXXXXXX</p> <p>gap <2/4/6> - Select delimiter gap.</p> <p>Related Syntax:</p> <ul style="list-style-type: none"> ● <config>#authentication mac ● <config>#authentication mac local <A:B:C:D:E:F> control auth inactive-timeout <60-65535> ● <config>#authentication mac local <A:B:C:D:E:F> control auth reauth-period <300-4294967294> ● <config>#authentication mac local <A:B:C:D:E:F> control auth vlan <1-4094> ● <config>#authentication mac local <A:B:C:D:E:F> control auth vlan<1-4094> reauth-period <300-4294967294> ● <config>#authentication mac local <A:B:C:D:E:F> control auth vlan<1-4094> reauth-period <300-4294967294> inactive-timeout <60-65535> ● <config>#authentication mac local <A:B:C:D:E:F> control unauth ● <config>#authentication mac radius mac-case <lower / upper> ● <config>#authentication mac radius mac-delimiter <colon/dot/hyphen/none> ● <config>#authentication mac radius mac-delimiter <colon/dot/hyphen/none> gap <2/4/6>
<p><i>authentication web</i></p>	<p>Web - Enable web authentication by entering the word "web" after "authentication".</p> <p>username <WORD> - Specify a username.</p> <p>password <string> - Set a password.</p> <p>vlan <1-4094> - Specify a VLAN ID by entering its number.</p> <p>reauth-period <30-4294967294> - Set a time to initiate automatic re-authentication.</p> <p>inactive-timeout <60-65535>- Set the inactive timeout for MAC authentication host. After the time interval, if there is no activity from the client, then it will be unauthorized by Vigor system.</p> <p>Related Syntax:</p> <ul style="list-style-type: none"> ● <config>#authentication web ● <config>#authentication web local username <WORD> password <string> inactive-timeout <60-65535> ● <config>#authentication web local username <WORD> password <string> reauth-period <300-4294967294> ● <config>#authentication web local username <WORD> password <string> reauth-period <300-4294967294> inactive-timeout <60-65535>

- <config>#authentication web local username <WORD> password <string> vlan<1-4094>
- <config>#authentication web local username <WORD> password <string> vlan<1-4094> reauth-period <30~4294967294> inactive-timeout <60~65535>

Example

```

P2121# configure
P2121(config)# authentication dot1x
P2121(config)# vlan 3
P2121(config-vlan)# exit
P2121(config)# authentication guest-vlan 3
P2121(config)#
P2121(config)# exit
P2121# show authentication
Authentication dot1x state      : enabled
Authentication mac state      : disabled
Authentication web state      : disabled
Guest VLAN                     : enabled (3)
Mac-auth Radius User ID Format : XXXXXXXXXXXXXXX
Mac-auth Local Entry          :
Web-auth Local Entry          :
Interface Configurations
Interface GigabitEthernet1
  Admin Control                : disable
  Host Mode                    : multi-auth
  Type dot1x State             : disabled
  Type mac State               : disabled
  Type web State               : disabled
  Type Order                   : dot1x
  MAC/WEB Method Order         : radius
  Guest VLAN                   : disabled
  Reauthentication             : disabled
  Max Hosts                    : 256
  VLAN Assign Mode             : static
--More--
.....
P2121# configure
P2121(config)# authentication mac local 00:11:22:33:00:01 control auth vlan
3 reauth-period 500 inactive-timeout 300
P2121(config)#
P2121(config)# authentication mac local 00:11:22:33:00:01 control unauth
P2121(config)#
P2121(config)# authentication web local username user_1 password 1234tw vlan
3 reauth-period 600 inactive-timeout 700
P2121(config)#

```

Telnet Command: boot

Use this command to have a backup image in the flash partition. Select the active firmware image, and another firmware image will become a backup one.

Syntax Items

boot system

Description

Syntax Items	Description
<i>boot system</i>	Boot the system from flash image partition 0 / 1. Related Syntax: <ul style="list-style-type: none">● <config># boot system image0● <config># boot system image1

Example

```
P2121# configure
P2121(config)#
P2121(config)# boot system image0
Select "image0" Success
P2121(config)# exit
P2121#
P2121# show boot
Image Version      Date                Status      File Name
-----
0          1.0.2             2017-08-29 09:44:57  Not active* 2280_r442_220RC1.all
1          2.3.2             2018-05-16 09:14:31  Active       p2280_r734_230RC4.all

"*" designates that the image was selected for the next boot

P2121#
```

Telnet Command: clock

Use this command to configure time zone, summer-time and external time source for the system clock.

Syntax Items

clock auto timezone
clock source local
clock source sntp
clock summer-time
clock timezone

Description

Syntax Items	Description
<i>clock auto timezone</i>	VigorSwitch sets the time zone automatically.
<i>clock source local</i>	Configure an external time source for the system clock. "local" means to use static time. It is the default setting. Related Syntax: <ul style="list-style-type: none">● <config># clock source local
<i>clock source sntp</i>	Configure an external time source for the system clock. "sntp" means to use SNTP time. Related Syntax: <ul style="list-style-type: none">● <config># clock source sntp
<i>clock summer-time</i>	Configure the system to automatically switch to summer time (daylight saving time). ACRONYM - Specify the acronym name of time zone. The acronym of the time zone will be displayed when summer time is in effect. If unspecified, the time zone acronym will be used in default. (1-4 chars) <jan/feb/mar/apr/may/jun/jul/aug/sep/oct/nov/dec> - Indicate January, February, March, April, May, June, July, August, September, October, November, December. <1-31> means date 1 to 31. <2000-2037> - means year of 2000 to 2035. <HH:MM> - means hours and minutes. recurring - Summer time should start and end on the corresponding specified days every year. <1-1440>- Set the number of minutes to add during the summer time. The default number is 60. eu - The summer time is based on the European Union rules. (Start point - last Sunday in March, End point - last Sunday in October) usa - The summer time is based on the United States rules. (Start point - second Sunday in March, End point - first Sunday in November) first - The first week of the month. last - The last week of the month. <sun/mon/tue/wed/thu/fri/sat> - Indicate Sunday, Monday, Tuesday, Wednesday, Thursday, Friday, Saturday. <jan/feb/mar/apr/may/jun/jul/aug/sep/oct/nov/dec> - Indicate January, February, March, April, May, June, July, August, September, October, November, December. <first/last>- Specify the first week or the last week of the month. <1-5> - Specify the number of the week in the month. Note that the first group of month, date, hour and minute is used for configuring starting time, and the second group is used for

	<p>configuring ending time.</p> <p>Related Syntax:</p> <ul style="list-style-type: none"> ● <config># clock summer-time ACRONYM date <jan/feb/mar/apr/may/jun/jul/aug/sep/oct/nov/dec> <1-31> <2000-2037> <HH:MM> <jan/feb/mar/apr/may/jun/jul/aug/sep/oct/nov/dec><1-31> ><2000-2037> <HH:MM> ● <config># clock summer-time ACRONYM recurring eu <1-1440> ● <config># clock summer-time ACRONYM recurring usa <1-1440> ● <config># clock summer-time ACRONYM recurring first <sun/mon/tue/wed/thu/fri/sat>< jan / feb / mar / apr / may / jun/jul/aug/sep/oct/nov/dec> <HH:MM> <first/last> <sun/mon/tue/wed/thu/fri/sat>< jan /feb /mar /apr/may/ jun/jul/aug/sep/oct/nov/dec> <HH:MM> <1-14400> ● <config># clock summer-time ACRONYM recurring last <sun/mon/tue/wed/thu/fri/sat>< jan /feb /mar /apr /may /jun/jul/aug/sep/oct/nov/dec> <HH:MM> <first/last><sun/mon/tue/wed/thu/fri/sat>< jan /feb /mar /apr/may/ jun/jul/aug/sep/oct/nov/dec> <HH:MM> <1-14400> ● <config># clock summer-time ACRONYM recurring <1-5> <sun/mon/tue/wed/thu/fri/sat>< jan /feb /mar /apr /may /jun/jul/aug/sep/oct/nov/dec> <HH:MM> <1-5> <sun/mon/tue/wed/thu/fri/sat>< jan /feb /mar /apr /may/jun/jul/aug/sep/oct/nov/dec> <HH:MM> <1-14400>
<p><i>clock timezone ACRONYM <-12-13> minutes <0-59></i></p>	<p>Set the time zone for display purposes.</p> <p>ACRONYM - Specify the acronym name of time zone. The acronym of the time zone will be displayed when summer time is in effect. If unspecified, the time zone acronym will be used in default. (1-4 chars)</p> <p><-12-13> - Specify the hour offset (from -12 to +13) of time zone.</p> <p>minutes <0-59> - Specify the minute difference from UTC.</p> <p>Related Syntax:</p> <ul style="list-style-type: none"> ● <config># clock timezone ACRONYM <-12-13> minutes <0-59>

Example

```

P2121# configure
P2121(config)# clock source sntp
P2121(config)# exit
P2121# show clock detail
2019-01-05 06:51:23 UTC+8
Time source is sntp
Time zone:
Acronym is
Offset is UTC+8
P2121# configure
P2121(config)# clock summer-time tw date jan 30 2019 23:30 feb 1 2019 20:50
P2121(config)# exit
P2121# show clock detail
2019-01-05 07:13:49 UTC+8
Time source is sntp

Time zone:
Acronym is ACRONYM
Offset is UTC-10:08

Summertime:

```

```

Acronym is tw
Starting and ending on a specific date.
Begins at 1 30 19 23:30
Ends at 2 1 19 20:50
Offset is 60 minutes.
P2121# configure
P2121(config)# clock summer-time ACRONYM recurring eu 1200
P2121(config)# clock summer-time ACRONYM recurring first mon jan 10:10 first
sun feb 10:10 1000
P2121(config)# exit
P2121# show clock detail
2019-01-05 11:37:18 UTC+8
Time source is sntp
Time zone:
Acronym is
Offset is UTC+8
Summertime:
Acronym is ACRONYM
Recurring every year.
Begins at 1 1 1 10:10
Ends at 1 0 2 10:10
Offset is 1000 minutes.

```

Telnet Command: custom

Use this command to enable the module settings.

Syntax Items

custom enable

Description

Syntax Items	Description
<i>custom enable</i>	Enable the module settings. Related Syntax: ● <config># custom enable

Example

```

P2121# configure
P2121(config)# custom enable
P2121(config)#

```

Telnet Command: dos

Use this command to enable specific Denial of Service (DoS) protection.

Syntax Items

```

dos daeqsa-deny
dos icmp-frag-pkts-deny
dos icmp-ping-max-length
dos icmpv4-ping-max-check
dos icmpv6-ping-max-check
dos ipv6-min-frag-size-check
dos ipv6-min-frag-size-length
dos land-deny

```

dos nullscan-deny
 dos pod-deny
 dos smurf-deny
 dos smurf-netmask
 dos syn-sport1024-deny
 dos synfin-deny
 dos synrst-deny
 dos tcp-frag-off-min-check
 dos tcpblat-deny
 dos tcphdr-min-check
 dos tcphdr-min-length
 dos udpblat-deny
 dos xma-deny

Description

Syntax Items	Description
<i>dos daeqsa-deny</i>	Drop the packets if the destination MAC address equals to the source MAC address. Related Syntax: ● <config># dos daeqsa-deny
<i>dos icmp-frag-pkts-deny</i>	Drop the fragmented ICMP packets. Related Syntax: ● <config># dos icmp-frag-pkts-deny
<i>dos icmp-ping-max-length</i>	Set the maximum packet size for ICMPv4/ICMPv6 ping operation. <0-65535> - Specify a packet number. Related Syntax: ● <config># dos icmp-ping-max-length <0-65535>
<i>dos icmpv4-ping-max-check</i>	Check ICMPv4 ping maximum packets size and drop the packets larger than the maximum packet size defined by the command, <i>dos icmp-ping-max-length</i> . Related Syntax: ● <config># dos icmpv4-ping-max-check
<i>dos icmpv6-ping-max-check</i>	Check ICMPv6 ping maximum packets size and drop the packets larger than the maximum packet size defined by the command, <i>icmp-ping-max-length</i> . Related Syntax: ● <config># dos icmpv6-ping-max-check
<i>dos ipv6-min-frag-size-check</i>	Check minimum size of IPv6 fragments. Related Syntax: ● <config># dos ipv6-min-frag-size-check
<i>dos ipv6-min-frag-size-length</i> <0-65535>	Set the minimum packet size of IPv6 fragmented packets. <0-65535> - Specify a packet number. Related Syntax: ● <config># dos ipv6-min-frag-size-length <0-65535>
<i>dos land-deny</i>	Drop the packets if the source IP address equals to destination IP address. Related Syntax: ● <config># dos land-deny
<i>dos nullscan-deny</i>	Drop the packets if attacked by NULL Scan. Related Syntax: ● <config># dos nullscan-deny
<i>dos pod-deny</i>	Drop the packets if attacked by Ping of Death.

	<p>Related Syntax:</p> <ul style="list-style-type: none"> ● <config># dos pod-deny
<i>dos smurf-deny</i>	<p>Drop the packets if encountered Smurf attack.</p> <p>Related Syntax:</p> <ul style="list-style-type: none"> ● <config># dos smurf-deny
<i>dos smurf-netmask</i>	<p>Set the smurf attack size.</p> <p><0-32> - Enter a number as smurf attacks size.</p> <p>Related Syntax:</p> <ul style="list-style-type: none"> ● <config># dos smurf-netmask <0-32>
<i>dos syn-sport11024-deny</i>	<p>Drop SYN packets with sport less than 1024.</p> <p>Related Syntax:</p> <ul style="list-style-type: none"> ● <config># dos syn-sport11024-deny
<i>dos synfin-deny</i>	<p>Drop the packets with SYN and FIN bits set.</p> <p>Related Syntax:</p> <ul style="list-style-type: none"> ● <config># dos synfin-deny
<i>dos synrst-deny</i>	<p>Drop the packets with SYNC and RST bits set.</p> <p>Related Syntax:</p> <ul style="list-style-type: none"> ● <config># dos synrst-deny
<i>dos tcp-frag-off-min-check</i>	<p>Drop the TCP fragmented packet with offset equals to the minimum packet size.</p> <p>Related Syntax:</p> <ul style="list-style-type: none"> ● <config># dos tcp-frag-off-min-check
<i>dos tcpblat-deny</i>	<p>Drop the packets if the source TCP port equals to destination TCP port.</p> <p>Related Syntax:</p> <ul style="list-style-type: none"> ● <config># dos tcpblat-deny
<i>dos tcphdr-min-check</i>	<p>Check the minimum TCP header and drop the TCP packets with the header smaller than the minimum size defined.</p> <p>Related Syntax:</p> <ul style="list-style-type: none"> ● <config># dos tcphdr-min-check
<i>dos tcphdr-min-length</i>	<p>Set the minimum size of TCP header.</p> <p><0-65535> - Specify a packet number.</p> <p>Related Syntax:</p> <ul style="list-style-type: none"> ● <config># dos tcphdr-min-length <0-65535>
<i>dos udpblat-deny</i>	<p>Drop the packets if the source UDP port equals to destination UDP port.</p> <p>Related Syntax:</p> <ul style="list-style-type: none"> ● <config># dos udpblat-deny
<i>dos xma-deny</i>	<p>Drop the packets if the sequence number is zero and the FIN, URG and PSH bits are set already.</p> <p>Related Syntax:</p> <ul style="list-style-type: none"> ● <config># dos xma-deny

Example

```
P2121# configure
P2121(config)#
P2121(config)# dos icmp-ping-max-length 25252
P2121(config)# dos icmpv4-ping-max-check
P2121(config)#
```

Telnet Command: dot1x

Use this command to set 802.1x configuration.

Syntax Items

dot1x

Description

Syntax Items	Description
<i>dot1x guest-vlan</i>	<0-4094> - Enter a number as guest VLAN ID. Related Syntax: <ul style="list-style-type: none">● <config># dot1x guest-vlan <0-4094>

Example

```
P2121(config)# dot1x guest-vlan 33
P2121(config)#
```

Telnet Command: do

Use this command to execute a command immediately.

Syntax Items

do SEQUENCE

Description

Syntax Items	Description
<i>SEQUENCE</i>	Enter the command that you want to execute immediately. Related Syntax: (for example) <ul style="list-style-type: none">● <config># do show info

Example

```
P2121(config)# do show info
System Name       : P2121
System Location   : Default
System Contact    : Default
MAC Address       : 14:49:BC:41:33:F4
IP Address        : 192.168.1.11
Subnet Mask       : 255.255.255.0
Loader Version    : 2.0.0
Loader Date       : Aug 30 2019 - 13:58:32
Firmware Version  : 2.5.1_RC5
Firmware Date     : Nov 28 2019 - 17:06:13
Firmware Revision : 1688
System Object ID  : 1.3.6.1.4.1.7367
System Up Time    : 3 days, 22 hours, 13 mins, 25 secs
P2121(config)#
```

Telnet Command: dray_surveillance

Use this command to enable / disable the ONVIF.

Syntax Items

`dray_surveillance add`

`dray_surveillance direct-add`

`dray_surveillance set`

Description

Syntax Items	Description
<i>dray_surveillance add</i>	Add an IP device for surveillance. WORD <36-36> - Enter the UUID string of the IP camera or IP-based device. Related Syntax: <ul style="list-style-type: none">● <config># dray_surveillance add device uuid WORD <36-36>● <config># dray_surveillance add group uuid WORD <36-36>
<i>dray_surveillance direct-add</i>	WORD <36-36> - Enter the UUID string of the IP camera or IP-based device. Related Syntax: <ul style="list-style-type: none">● <config># dray_surveillance direct-add device uuid WORD <36-36>
<i>dray_surveillance set</i>	WORD <36-36> - Enter the UUID string of the IP camera or IP-based device. Related Syntax: <ul style="list-style-type: none">● <config># dray_surveillance set device uuid WORD <36-36>● <config># dray_surveillance set group uuid WORD <36-36>

Example

```
P2121# configure
P2121(config)#
P2121(config)# dray_surveillance
P2121(config)#
P2121(config)# dray_surveillance add device uuid
```

```
53d7762a-c52b-4bb9-8000-305501e0f35f
P2121(config)#
```

Telnet Command: enable

Use this command to configure local password with encrypted string or not.

Syntax Items

```
enable password
enable privilege
enable secret
```

Description

Syntax Items	Description
<i>enable password</i>	<PASSWORD> - Edit the password for each privilege level for activating authentication. Related Syntax: <ul style="list-style-type: none">● <config># enable password PASSWORD
<i>enable privilege</i>	Edit the privilege level of the password for local user. <1-15> - Enter a number for specifying a privilege level. Default value is 15. <string> - Enter a new string as the password. Related Syntax: <ul style="list-style-type: none">● <config># enable privilege <1-15> password <string> (This password will NOT be encrypted.)● <config># enable privilege <1-15> secret <string> (This password will BE encrypted.)● <config># enable privilege <1-15> secret encrypted <string> (This password is copied from another configuration file. So, enter an existed and encrypted password.)
<i>enable secret</i>	<PASSWORD> - Enter a new string as the encrypted password. Related Syntax: <ul style="list-style-type: none">● <config># enable secret PASSWORD● <config># enable secret encrypted PASSWORD

Example

```
P2121# configure
P2121(config)# enable secret encrypted testttest
P2121(config)# exit
P2121# show running-config
P2121# ...
enable privilege 2 secret "OTE5ZTY4MmNhYzgyNWQ0MzBhNTgwZTg0MmZmMGJiYzQ="
enable secret "testttest"
vlan 2
  name "test0002"
vlan 3
  name "test0003"
vlan 5
  name "test_carrie"
voice-vlan oui-table 00:E0:BB "3COM"
voice-vlan oui-table 00:03:6B "Cisco"
voice-vlan oui-table 00:E0:75 "Veritel"
```

```
.....
```

Telnet Command: end

Use this command to end current mode.

Syntax Items

end

Example

```
P2121# configure
P2121(config)#end
P2121#
```

Telnet Command: errdisable

Use this command to enable the auto recovery timer for port error.

Syntax Items

errdisable recovery cause
errdisable recovery interval

Description

Syntax Items	Description
<i>errdisable recovery cause</i>	Enable the auto recovery timer for port error disabled from ACL, all, ARP rate limit, STP BPDU guard, broadcast flooding, DHCP rate limit, port security, STP self-loop, unicast flooding, or unknown multicast flooding causes. Related Syntax: <ul style="list-style-type: none">● <config># errdisable recovery cause < acl /all /arp-inspection /bpduguard /broadcast-flood /dhcp-rate-limit /psecure-violation /selfloop /unicast-flood /unknown-multicast-flood >
<i>errdisable recovery interval</i>	Set the recovery time of the error disabled port. <30-86400> - The default value is 300 seconds. Related Syntax: <ul style="list-style-type: none">● <config># errdisable recovery interval <30-86400>

Example

```
P2121# configure
P2121(config)#
P2121(config)# errdisable recovery interval 600
P2121(config)#
```

Telnet Command: exit

Use this command to exit current mode and return to previous mode/phase.

Syntax Items

exit

Example

```
P2121# configure
P2121(config)#
P2121(config)# exit
P2121#
```

Telnet Command: gvrp

Use this command to enable the GVRP configuration. In default, the GVRP is disabled.

Syntax Items

gvrp

Example

```
P2121# configure
P2121(config)# gvrp
P2121(config)#
P2121(config)# exit
P2121# show gvrp
          GVRP      Status
          -----
GVRP                : Enabled
Join time            : 200 ms
Leave time            : 600 ms
LeaveAll time         : 10000 ms
P2121#
```

Telnet Command: hostname

Use this command to modify the network name of VigorSwitch.

Syntax Items

hostname

Description

Syntax Items	Description
<i>hostname</i>	<word> - Enter a string as the network name for VigorSwitch. Related Syntax: <ul style="list-style-type: none"> ● <config># hostname <word>

Example

```
P2121# configure
P2121(config)# hostname Switch_3F
Switch_3F(config)#
```

Telnet Command: interface

Use this command to configure interface settings.

Before configuring, you have to access into next phase. See the following example:

```
P2121# configure
P2121(config)#
P2121(config)# interface GigabitEthernet 3
```

```
P2121(config-if)#
```

Or

```
P2121# configure
P2121(config)#
P2121(config)# interface range LAG 3
P2500(config-if-range)#
```

Syntax Items

interface GigabitEthernet
interface LAG
interface range

Description

Syntax Items	Description
<i>interface GigabitEthernet</i>	<1-12> - Specify the number of Ethernet LAN port. Related Syntax: <ul style="list-style-type: none">● <config># interface GigabitEthernet <1-12>
<i>interface LAG</i>	<1-8> - Specify the number of LAG interface. Related Syntax: <ul style="list-style-type: none">● <config># interface LAG <1-8>
<i>Interface range</i>	Specify an interface ranges for configuring detailed settings. Related Syntax: <ul style="list-style-type: none">● <config># interface range GigabitEthernet <1-12>● <config># interface range LAG <1-8>

Example

```
P2121# configure
P2121(config)# interface LAG 1
P2121(config-if)#
```

Under (config-if)#, available sub-commands for LAN or LAG will be different. Below shows the items under Ethernet LAN:

```
<config-if># authentication
<config-if># back-pressure
<config-if># custom
<config-if># description
<config-if># device-check
<config-if># dos
<config-if># dot1x
<config-if># do
<config-if># dray_surveillance
<config-if># duplex
<config-if># eee
<config-if># end
<config-if># exit
<config-if># flowcontrol
<config-if># gvrp
<config-if># ip
<config-if># ipv6
<config-if># lacp
<config-if># lag
```



```

<config-if># lldp
<config-if># mac
<config-if># mvr
<config-if># no
<config-if># poe
<config-if># port-security
<config-if># power
<config-if># protected
<config-if># qos
<config-if># rate-limit
<config-if># shutdown
<config-if># spanning-tree
<config-if># speed
<config-if># storm-control
<config-if># surveillance-vlan
<config-if># switchport
<config-if># udd
<config-if># vlan
<config-if># voice-vlan

```

Description

Syntax Items	Description
<i>authentication</i>	<p>Apply Auth Manager Port Configuration Commands to the specified interface (Ethernet port/LAG port).</p> <p>dot1x - Execute the 802.1x authentication.</p> <p>guest-vlan - Authenticate the guest VLAN configuration.</p> <p>host-mode <multi-auth / multi-host / single-host> - Set the host mode for authentication on this port.</p> <p>max-hosts <1-256> - Set the maximum number of authenticated hosts allowed on this port.</p> <p>method <local/radius> - Set authentication method by using local or RADIUS server.</p> <p>order <dot1x / mac /web> - Add an authentication type to the order list.</p> <p>port-control <auto / force-auth / force-unauth> - Set the port state of this port as AUTO, Authorized or Unauthorized.</p> <p>radius-attributes vlan reject - If the Radius server authorizes the supplicant, but does not provide a supplicant VLAN, the supplicant will be rejected. If the parameter is omitted, the option is applied by default.</p> <p>radius-attributes vlan static - If the Radius server authorizes the supplicant but does not provide a supplicant VLAN, the supplicant will be accepted.</p> <p>reauth - Enable/Disable Reauthentication for this port</p> <p>timer <inactive> <60-65535> - Set the time value for authentication. After the time interval, if there is no activity from the client, it will be unauthorized.</p> <p>timer quiet <0-65535> - Set the time value to wait failed authentication exchange.</p> <p>timer reauth <300-4294967294> - Set the time value. After the time interval, an automatic re-authentication should be initiated.</p> <p>web - Execute the web-based authentication.</p> <p>web max-login-attempts <3-10> - Set a maximum number of login attempts on the port.</p> <p>web max-login-attempts infinite - No limit for login attempts.</p> <p>Related Syntax:</p> <ul style="list-style-type: none"> ● <config-if># authentication dot1x ● <config-if># authentication guest-vlan

	<ul style="list-style-type: none"> ● <config-if># authentication host-mode <multi-auth / multi-host / single-host> ● <config-if># authentication mac ● <config-if># authentication max-hosts <1-256> ● <config-if># authentication method <local/radius> ● <config-if># authentication order <dot1x / mac /web> ● <config-if># authentication port-control <auto / force-auth / force-unauth> ● <config-if># authentication radius-attributes vlan reject ● <config-if># authentication radius-attributes vlan static ● <config-if># authentication reauth ● <config-if># authentication timer inactive <60-65535> ● <config-if># authentication timer quiet <0-65535> ● <config-if># authentication timer reauth <300-4294967294> ● <config-if># authentication web ● <config-if># authentication web max-login-attempts <3-10> ● <config-if># authentication web max-login-attempts infinite
<i>back-pressure</i>	<p>Enable back-pressure for the specified interface (Ethernet port/LAG port).</p> <p>Related Syntax:</p> <ul style="list-style-type: none"> ● <config-if># back-pressure
<i>custom</i>	<p><enable> - Enable the custom module configuration for the specified interface (Ethernet port/LAG port).</p> <p>Related Syntax:</p> <ul style="list-style-type: none"> ● <config-if># custom enable
<i>description</i>	<p>Write a description for the specified interface (Ethernet port/LAG port).</p> <p><WORD> - Enter a description (up to 32 characters).</p> <p>Related Syntax:</p> <ul style="list-style-type: none"> ● <config-if># descripton <WORD>
<i>device-check</i>	<p>Perform a device check the specified interface (Ethernet port/LAG port).</p> <p>ip-address<A.B.C.D> - Enter the IP address of the device.</p> <p>interval <120/15/30/60>- Check the device interval by entering the time value. Unit is second.</p> <p>retry <1/3/5> - Enter the retry time during a checking period.</p> <p>Failure-action <nothing/powercycle/poweroff> - Set the power cycle.</p> <p>Related Syntax:</p> <ul style="list-style-type: none"> ● <config-if># device-check ip-address <A.D.C.D> interval <120/15/30/60> retry <1/3/5> failure-action <nothing/powercycle/poweroff>
<i>dos</i>	<p>Apply DoS to the specified interface (Ethernet port/LAG port).</p>
<i>dot1x</i>	<p>It is available for GigabitEthernet port only.</p> <p>guest-vlan - Set guest VLAN configuration.</p> <p>max-req <1-10>- Set the maximum request retries. Default is 2.</p> <p>Port-control <auto/force-auth/force-unauth>- Set the port control value (auto, authorized or unauthorized)</p> <p>reauth - Enable/disable the reauthenticaiton for this port.</p> <p>timeout <quiet-period / reauth-period / server-timeout /supp-timeout /tx-period>- Set timeout value for this port.</p> <p><0-65535> - Set a value as quiet period (default is 60-second).</p> <p><300-4294967294> - Set a value as re-authentication period. (default</p>

	<p>is 3600-second).</p> <p><1-65535> - Set a value to wait for a packet retransmission to the authentication server.</p> <p>supp-timeout <1-65535> - Set a value as supplicant timeout period.</p> <p>tx-period <1-65535> - Set a value to wait for a response to an EAP-request / identity before resending the request.</p> <p>Related Syntax:</p> <ul style="list-style-type: none"> ● <config-if># dot1x guest-vlan ● <config-if># dot1x max-req <1-10> ● <config-if># dot1x port-control <auto /force-auth /force-unauth > ● <config-if># dot1x reauth ● <config-if># dot1x timeout quiet-period <0-65535> ● <config-if># dot1x timeout reauth-period <300-4294967294> ● <config-if># dot1x timeout server-timeout <1-65535> ● <config-if># dot1x timeout supp-timeout <1-65535> ● <config-if># dot1x timeout tx-period <1-65535>
<i>do</i>	Run execution commands in current mode.
<i>dray_surveillance</i>	<p>Use this command to set the ONVIF throughput alert threshold.</p> <p><16-1000000> - Specify a number as the alert threshold for egress /ingress throughput.</p> <p>Related Syntax:</p> <ul style="list-style-type: none"> ● <config-if>#dray_surveillance set threshold alert egress <16-1000000> ● <config-if>#dray_surveillance set threshold alert ingress <16-1000000>
<i>duplex</i>	<p>Apply the duplex configuration to the specified interface (Ethernet port/LAG port).</p> <p><Auto> - Auto duplex configuration.</p> <p><Full>- Force full duplex operation.</p> <p><Half> - Force half-duplex operation.</p> <p>Related Syntax:</p> <ul style="list-style-type: none"> ● <config-if># duplex <auto/full/half>
<i>eee</i>	Apply the EEE configuration to the specified interface (Ethernet port).
<i>end</i>	End current mode, change to enable mode and return to previous phase.
<i>exit</i>	Exit from current mode.
<i>flowcontrol</i>	<p>Configure flow-control mode to the specified interface (Ethernet port/LAG port).</p> <p><Auto> - Enable AUTO flow-control configuration.</p> <p><Off> - Disable the force flow-control.</p> <p><On> - Enable the force flow-control.</p> <p>Related Syntax:</p> <ul style="list-style-type: none"> ● <config-if># flowcontrol <auto/off/on>
<i>gvrp</i>	<p>Apply the GVRP configuration to the specified interface (Ethernet port/LAG port).</p> <p>registration-mode <fixed / forbidden / normal>- Set registration mode for GVRP. When registration-mode is fixed or forbidden, it will remove the dynamic port from VLAN.</p> <p>vlan-creation-forbid - Do not remove dynamic port from VLAN.</p> <p>Related Syntax:</p> <ul style="list-style-type: none"> ● <config-if># gvrp registration-mode <fixed / forbidden /

	<p>normal></p> <ul style="list-style-type: none"> ● <config-if># gvrp vlan-creation-forbid
<p><i>ip</i></p>	<p>Apply IP configuration to the specified interface (Ethernet port/LAG port).</p> <p>acl <NAME> - Specify an ACL for packets. Enter the name of the ACL.</p> <p>arp inspection rate-limit <1-12> - ARP inspection is to enable Dynamic ARP Inspection function. Set the rate limitation (1 - 50) on the interface. VigorSwitch will drop ARP packets after receives more than configured rate of packets per second.</p> <p>arp inspection trust - Use it to set trusted interface.</p> <p>arp inspection validate dst-mac - It means the switch will drop ARP reply packets if arp-target-mac and ethernet-dst-mac are not matched.</p> <p>arp inspection validate ip allow-zeros - The "allow-zeros" means the switch will not drop all zero IP address.</p> <p>arp inspection validate src-mac - It means the switch will drop ARP requests and reply packets if arp-sender-mac and ethernet-source-mac are not matched.</p> <p>conflict prevention bind-ip <A.B.C.D> -</p> <p>conflict prevention port-type DHCP-Client -</p> <p>conflict prevention port-type DHCP-Client has-server -</p> <p>conflict prevention port-type DHCP-Server -</p> <p>conflict prevention port-type DHCP-Server has-server -</p> <p>conflict prevention port-type Multiple-Hosts -</p> <p>conflict prevention port-type Multiple-Hosts has-server -</p> <p>conflict prevention port-type Static-Binding -</p> <p>conflict prevention port-type Static-Binding has-server -</p> <p>dhcp snooping option - Use it to enable the function of inserting option82 content into the packet.</p> <p>dhcp snooping option action <drop / keep / replace> - Use it to set the action (drop, keep or replace) when receiving packets with option82 content.</p> <p>dhcp snooping option circuit-id <STRING> - Use it to set user-defined circuit-id string (1 to 63 characters).</p> <p>dhcp snooping rate-limit <1-300> - Use it to set rate limitation on the interface.</p> <p>dhcp snooping trust - Use it to set trusted interface.</p> <p>dhcp snooping verify mac-address - Use it to verify MAC address function on the interface.</p> <p>dhcp snooping vlan <1-4094> option circuit-id <STRING> - Set user-defined circuit-id string for specified VLAN ID.</p> <p>igmp filter <1-128> - Use it to bind a profile for a port. Specify a profile ID.</p> <p>igmp max-groups <0-256> - Use it to limit port learning max group number (0-256).</p> <p>igmp max-groups action <deny/replace> - Use it to set the action (deny or replace) when the number of groups reach the limitation.</p> <p>source binding max-entry <1-12> -</p> <p>source binding max-entry no-limit -</p> <p>source verify mac-and-ip - Use it to enable IP source guard function.</p> <p>Related Syntax:</p> <ul style="list-style-type: none"> ● <config-if># ip acl <NAME> ● <config-if># ip arp inspection rate-limit <1-12> ● <config-if># ip arp inspection trust ● <config-if># ip arp inspection validate dst-mac ● <config-if># ip arp inspection validate ip allow-zeros

	<ul style="list-style-type: none"> ● <config-if># ip arp inspection validate src-mac ● <config-if># ip conflict prevention bind-ip <A.B.C.D> ● <config-if># ip conflict prevention port-type DHCP-Client ● <config-if># ip conflict prevention port-type DHCP-Client has-server ● <config-if># ip conflict prevention port-type DHCP-Server ● <config-if># ip conflict prevention port-type DHCP-Server has-server ● <config-if># ip conflict prevention port-type Multiple-Hosts ● <config-if># ip conflict prevention port-type Multiple-Hosts has-server ● <config-if># ip conflict prevention port-type Static-Binding ● <config-if># ip conflict prevention port-type Static-Binding has-server ● <config-if># ip dhcp snooping option ● <config-if># ip dhcp snooping option action <drop / keep / replace> ● <config-if># ip dhcp snooping option circuit-id <STRING> ● <config-if># ip dhcp snooping rate-limit <1-300> ● <config-if># ip dhcp snooping trust ● <config-if># ip dhcp snooping verify mac-address ● <config-if># ip dhcp snooping vlan <1-4094> option circuit-id <STRING> ● <config-if># ip igmp filter <1-128> ● <config-if># ip igmp max-groups <0-256> ● <config-if># ip igmp max-groups action <deny/replace> ● <config-if># ip source binding max-entry <1-12> ● <config-if># ip source binding max-entry no-limit ● <config-if># ip source verify mac-and-ip
<i>ipv6</i>	<p>Apply IPV6 configuration to the specified interface (Ethernet port/LAG port).</p> <p>acl <NAME> - Specify the ACL name for packets</p> <p>mld <filter> - Set IPv6 filter for MLD configuration.</p> <p>mld max-groups - Specify the number for maximum group.</p> <p><0-256> - MLD snooping group number.</p> <p>action <deny /replace> - Define the action to be performed when exceeding the maximum group.</p> <p>Related Syntax:</p> <ul style="list-style-type: none"> ● <config-if># ipv6 acl <NAME> ● <config-if># ipv6 mld filter ● <config-if># ipv6 mld max-groups <0-256> ● <config-if># ipv6 mld max-groups action <deny / replace>
<i>lacp</i>	<p>Apply LACP Configuration to the specified interface (Ethernet port/LAG port).</p> <p><1-65535> - Set a number for IEEE 802.3 link aggregation port priority.</p> <p><long/short> - Set long or short timeout value.</p> <p>Related Syntax:</p> <ul style="list-style-type: none"> ● <config-if># lacp port-priority <1-65535> ● <config-if># lacp timeout <long/short>
<i>lag</i>	<p>Apply Link Aggregation Group Configuration the specified interface (Ethernet port/LAG port).</p> <p><1-8> - Specify LAG number.</p>

	<p>Related Syntax:</p> <ul style="list-style-type: none"> ● <config-if># lag <1-8>
<i>lldp</i>	<p>med location - Configure the LLDP MED location data. The "coordinate", "civic-address", "ecs-elin" locations are independent, so at most three location TLVs could be sent if their data are not empty.</p> <p>med network-policy add / remove - Configure the LLDP MED network policy table. Add /remove a network policy entry that can be bind to ports.</p> <p>med tlv-select - Configure LLDP MED TLVs selection. Available optional TLVs are network-policy, location, inventory and poe-pse.</p> <p>tlv-select - Select LLDP TLVs to send.</p> <p><civic-address> - The location is specified as civic address.</p> <p> <ADDR> - Range from 6 to 160 hexadecimal bytes.</p> <p><Coordinate> - The location is specified as coordinates.</p> <p> <ADDR> - 16 hexadecimal bytes exactly.</p> <p><ecs-elin> - The location is specified as ECS ELIN.</p> <p> <ADDR> - 10 to 25 hexadecimal bytes.</p> <p><IDX_LIST> - Range from 1 to 32.</p> <p><TLV> - LLDP optional TLV, pick from: port-desc, sys-name, sys-desc, sys-cap, mac-phy, lag, max-frame-size, management-addr.</p> <p>pvid <disable/enable> - Enable or disable the TX optional-TLV 802.1 PVID.</p> <p>vlan-name <add/remove> <2-4094> - Add/remove a selected VLAN. Enter the VLAN ID number.</p> <p><rx> - Enable LLDP reception on interface.</p> <p><tx> - Enable LLDP transmission on interface.</p> <p>Related Syntax:</p> <ul style="list-style-type: none"> ● <config-if># lldp med location <civic-address/coordinate/ecs-elin> <ADDR> ● <config-if># lldp med network-policy add <IDX_LIST> ● <config-if># lldp med network-policy remove <IDX_LIST> ● <config-if># lldp med tlv-select <network-policy/location/inventory/poe-pse> <network-policy/location/inventory/poe-pse> <network-policy/location/inventory/poe-pse> ● <config-if># lldp tlv-select <TLV/pvid/vlan-name> ● <config-if># lldp tlv-select pvid <disable/enable> ● <config-if># lldp tlv-select vlan-name <add/remove> <2-4094> ● <config-if># lldp <rx/tx>
<i>mac</i>	<p>Specify an access control list for packets.</p> <p>Before configuring, you have to create an ACL based on MAC address. For example,</p> <pre> <config># mac acl CA_ACL <config-mac-acl># </pre> <p><NAME> - Enter a name for ACL.</p> <p>Related Syntax:</p> <ul style="list-style-type: none"> ● <config-if># mac acl <NAME>
<i>mvr</i>	<p>Make MVR configuration.</p> <p>immediate - Enable MVR function.</p> <p>type <receiver/source> - Specify MVR port type as receiver or source.</p> <p>Related Syntax:</p> <ul style="list-style-type: none"> ● <config-if># mvr immediate ● <config-if># mvr type <receiver/source>

<i>no</i>	<p>Negate command. Such command can disable current setting of command executed and return to the factory setting of that command.</p> <p>Example:</p> <pre><config-if> # no mvr</pre> <p>The operation will make mvr setting is default. Continue? [yes/no]:yes</p> <pre><config-if> #</pre> <p>Related Syntax:</p> <ul style="list-style-type: none"> ● <config-if># no <command>
<i>poe</i>	<p>Enable or disable the PoE port.</p>
<i>port-security</i>	<p>port-security - Enable the port security functionality. Default is disabled.</p> <p>address-limit <1-256>- Enter the number as limitation for MAC address.</p> <p>action <discard / forward / shutdown> - Specify an action to be performed.</p> <p>Related Syntax:</p> <ul style="list-style-type: none"> ● <config-if># port-security ● <config-if># port-security addresss-limit <1-256> action <discard / forward / shutdown>
<i>power</i>	<p>Configure the inline power for the PoE device.</p> <p>inline auto - Turn on the PoE device discovery protocol and apply the power to the devcie.</p> <p>inline never - Turn off the PoE device power.</p> <p>power-limit <15.4w/30w/MW> - Set the power limit for the PoE device.</p> <p>priority <1-3/critical/high/low> - Set the priority of power application for the PoE device.</p> <p>schedule-index - Specify the index number of the schedule profile.</p> <p>Related Syntax:</p> <ul style="list-style-type: none"> ● <config-if># power inline auto ● <config-if># power inline never ● <config-if># power power-limit <15.4w/30w/MW> ● <config-if># power priority <1-3/critical/high/low> ● <config-if># power schedule-index
<i>protected</i>	<p>Configure an interface to be a protected port.</p> <p>Related Syntax:</p> <ul style="list-style-type: none"> ● <config-if>#protected
<i>qos</i>	<p>cos - Configure the default CoS value for an Ethernet port.</p> <p><0-7> - Specify a CoS value for the selected interface. Default value is 0.</p> <p>remark - Configure remarking state of each port.</p> <p>trust - Configure each port to trust state while the system is in "basic" mode. There are four trust types for a device to judge the appropriate queue of the packets.</p> <p><cos> - Enable cos remarking.</p> <p><dscp> - Enable DSCP remarking.</p> <p><cos-dscp> - Enable cos and DSCP remarking.</p> <p><precedence> - Enable IP precedence remarking.</p> <p>Related Syntax:</p> <ul style="list-style-type: none"> ● <config-if>#qos cos <0-7> ● <config-if>#qos remark <cos/dscp/precedence>

	<ul style="list-style-type: none"> ● <config-if>#qos trust <cos/cos-dscp/ dscp/precedence>
<i>rate-limit</i>	<p>It is effective for Ethernet port only.</p> <p>egress - Configure the egress port shaper.</p> <p>ingress - Configure the ingress port shaper.</p> <p>egress queue - Configure queue for egress port shaper.</p> <p><0-1000000> - Enter a number as the average traffic rate in Kbps. It must be a multiple of 16.</p> <p><16-1000000> - Enter a number as the average traffic rate in Kbps. It must be a multiple of 16.</p> <p><1-8> - Specify a nubmer as queue ID.</p> <p>Related Syntax:</p> <ul style="list-style-type: none"> ● <config-if># rate-limit egress <0-1000000> ● <config-if># rate-limit egress queue <1-8> <16-1000000> ● <config-if># rate-limit ingress <16-1000000>
<i>shutdown</i>	<p>Disable the selected interface.</p> <p>Example:</p> <pre>(config)# interface gigabitethernet 3 (config-if)# shutdown (config-if)# exit (config)# exit # show interface Gigabitethernet 3 GigabitEthernet3 is down</pre> <p>Related Syntax:</p> <ul style="list-style-type: none"> ● <config-if># shutdown
<i>spanning-tree</i>	<p>Configure spanning-tree settings.</p> <p>bpdu-filter - Set the BPDU-Filter for specified port.</p> <p>bpdu-guard - Set the BPDU-Guard for specified port.</p> <p>edge - Set the edge-port for specified port.</p> <p>cost - Change an interface's spanning tree path cost.</p> <p>link-type - Specify a link type for spanning tree protocol use.</p> <p>mcheck - Set the mcheck for specified port to migrate.</p> <p>mst - Set spanning-tree parameters of instance.</p> <p>port-priority- Set the priority for specified instance.</p> <p><0-200000000> - Specify a value of internal path cost (0 means Auto).</p> <p><point-to-point> - The selected port will be treated as point-to-point.</p> <p><shared> - The selected port will be treated as shared.</p> <p><0-15> - Specify an instance ID.</p> <p><0-240> - Specify a priority number for the selected port.</p> <p>Related Syntax:</p> <ul style="list-style-type: none"> ● <config-if># spanning-tree <bpdu-filter /bpdu-guard/ edge> ● <config-if># spanning-tree cost <0-200000000> ● <config-if># spanning-tree link-type <point-to-point/shared> ● <config-if>#spanning-tree mcheck ● <config-if>#spanning-tree mst <0-15> cost <0-200000000> ● <config-if># spanning-tree port-priority <0-240>
<i>speed</i>	<p>Configure speed operation.</p> <p><10/100/1000> - Force 10/100/1000 Mbps operation.</p> <p><auto> - Enable Auto speed configuration.</p> <p>Related Syntax:</p> <ul style="list-style-type: none"> ● <config-if># speed<10/100/1000>

	<ul style="list-style-type: none"> ● <config-if># speed auto
<i>storm-control</i>	<p>action - Select an action for storm control after exceeding the threshold.</p> <p>broadcast level - Enable the storm control type of broadcast for the selected port.</p> <p>unknown-multicast level - Enable the storm control type of unknown-multicast for the selected port.</p> <p>unknown-unicast level- Enable the storm control type of unknown-unicast for the selected port.</p> <p><drop> - Drop packets after exceeding storm control threshold.</p> <p><shutdown> - Disable the port after exceeding storm control threshold.</p> <p><1-1000000> - Specify the rate value.</p> <p>Related Syntax:</p> <ul style="list-style-type: none"> ● <config-if># storm-control action <drop/shutdown> ● <config-if># storm-control broadcast level <1-1000000> ● <config-if># storm-control unknown-multicast level <1-1000000> ● <config-if># storm-control unknown-unicast level <1-1000000>
<i>surveillance-vlan</i>	<p>cos - Set surveillance VLAN configuration.</p> <p>mode - Set surveillance member port join mode.</p> <p><all> - QoS attributes are applied to all packets that are classified to the Surveillance VLAN.</p> <p><src> - QoS attributes are applied only on packets from IP phones.</p> <p><auto> - Make surveillance member port join voice VLAN automatically.</p> <p><manual> - The administrator manually makes surveillance member port join voice VLAN.</p> <p>Related Syntax:</p> <ul style="list-style-type: none"> ● <config-if># surveillance-vlan cos <all/src> ● <config-if># surveillance-vlan mode <auto/manual>
<i>switchport</i>	<p>Set switching mode characteristics.</p> <p>access vlan -Use it to set a native VLAN on the interface.</p> <p>default-vlan tagged - Use it to make the selected port interface to become the default VLAN tagged member.</p> <p>forbidden default-vlan - Use it to forbid the default-vlan on the interface.</p> <p>forbidden vlan - Use it to forbid a vlan on the interface.</p> <p>hybrid acceptable-frame-type - Use it to choose which type of frame will be accepted.</p> <p>hybrid allowed - Use it to allow a VLAN set on the interface.</p> <p>hybrid ingress-filtering - Use it to enable VLAN ingress filter.</p> <p>hybrid pvid - Use it to set PVID of the interface.</p> <p>mode access - Use it to configure the selected port as the role of access. Only untagged frames will be accepted.</p> <p>mode hybrid - Use it to configure the selected port as the role of hybrid. Support all functions defined in IEEE 802.1Q specification.</p> <p>mode trunk uplink - Use it to configure the selected port as the role of trunk. It can recognize double tagging on the interface.</p> <p>trunk allowed - Use it to allow a VLAN on the interface.</p> <p>trunk native - Use it to set a native VLAN on the interface.</p> <p>tunnel vlan - Use it to set a Dot1q tunnel VLAN on the interface.</p> <p>vlan tpid - Use it to set TPID on the interface.</p> <p><1-4094> - Specify a VLAN ID.</p> <p><add/remove> - Add or remove the allowed VLAN list.</p>

	<p><all/tagged-only/untagged-only> - Specify an option for accepting all frames, only tagged frames or only untagged frames.</p> <p><1-4094/all> - Specify a VLAN ID or all VLAN IDs.</p> <p>< 0x8100 / 0x88A8 / 0x9100 / 0x9200> - Specify one tag-protocol-id.</p> <p>Related Syntax:</p> <ul style="list-style-type: none"> ● <config-if># switchport access vlan <1-4094> ● <config-if># switchport default-vlan tagged ● <config-if># switchport forbidden default-vlan ● <config-if># switchport forbidden vlan <add/remove> <1-4094> ● <config-if># switchport hybrid acceptable-frame-type <all/tagged-only/untagged-only> ● <config-if># switchport hybrid allowed vlan add <1-4094> ● <config-if># switchport hybrid allowed vlan add <1-4094> <tagged/ untagged> ● <config-if># switchport hybrid allowed vlan remove <1-4094> ● <config-if># switchport hybrid ingress-filtering ● <config-if># switchport hybrid pvid <1-4094> ● <config-if># switchport mode <access/hybrid> ● <config-if># switchport mode trunk uplink ● <config-if># switchport trunk allowed vlan <add /remove> <1-4094/all> ● <config-if># switchport trunk native <1-4094> ● <config-if># switchport tunnel vlan <1-4094> ● <config-if># switchport vlan tpid < 0x8100/0x88A8 / 0x9100 / 0x9200>
<i>udld</i>	<p>Configure UDLD enabled or disabled and ignore global UDLD setting.</p> <p>aggressive - Enable UDLD protocol on such interface.</p> <p>Related Syntax:</p> <ul style="list-style-type: none"> ● <config-if># udld ● <config-if># udld aggressive
<i>vlan</i>	<p>mac-vlan group - Set a MAC-based VLAN configuration.</p> <p>protocol-vlan group - Set a protocol-based VLAN configuration.</p> <p><1-2147483647> - Specify a group ID to map.</p> <p><1-4094> - Specify a VLAN ID.</p> <p>Related Syntax:</p> <ul style="list-style-type: none"> ● <config-if># vlan mac-vlan group <1-2147483647> vlan <1-4094> ● <config-if># vlan protocol-vlan group<1-2147483647> vlan <1-4094>
<i>voice-vlan</i>	<p>cos - Set voice VLAN configuration as COS mode.</p> <p>mode - Set voice member port join mode.</p> <p><all> - QoS attributes are applied on all packets that are classified to the Voice VLAN.</p> <p><src> - QoS attributes are applied only on packets from IP phones.</p> <p><auto> - Make voice member port join voice VLAN automatically.</p> <p><manual> - The administrator manually makes voice member port join voice VLAN.</p> <p>Related Syntax:</p> <ul style="list-style-type: none"> ● <config-if># voice-vlan cos <all/src> ● <config-if># voice-vlan mode <auto/manual>

Example

```

P2121# configure
P2121(config)# interface LAG 1
P2121(config-if)# speed 100
P2121(config-if)# backpressure
P2121(config-if)# lldp med location ecs-elin 112233445566778899AA
P2121(config-if)# vlan mac-vlan group 35 vlan 1000
P2121(config-if)#

```

Telnet Command: ip

Use this command to create an IPv4 access list (ACL) which performs classification on layer 3 fields and enters ip-access configuration mode.

Syntax Items

```

ip acl
ip address
ip arp
ip conflict
ip default-gateway
ip dhcp
ip dns
ip forcedhttps
ip http
ip https
ip igmp
ip source
ip ssh
ip telnet

```

Description

Syntax Items	Description
<i>ip acl</i>	<p>acl <NAME> - Set the name of the access list (ACL) based on IPv4. To configure detailed settings, enter the name of ACL to access into next level.</p> <pre><config>#ip acl <NAME></pre> <p>Then, available sub-command includes:</p> <pre><config-ip-acl>#deny <config-ip-acl>#do <config-ip-acl>#end <config-ip-acl>#exit <config-ip-acl>#permit <config-ip-acl>#sequence <config-ip-acl>#show</pre> <hr/> <p>Use the "deny" command to create deny rules for the IPv4 access list.</p> <pre><0-255/egp/hmp/icmp/igp/ipinip/ipv6 /ipv6:frag /ipv6:icmp /ipv6:rout / ip / l2tp /ospf /pim / rdp / rsvp /tcp /udp ></pre> - Specify the IP protocol number or enter the name of the protocol. <pre><A.B.C.D>/<A.B.C.D> <A.B.C.D>/<A.B.C.D></pre> - Specify the source and destination IPv4 addresses and subnet masks. <pre>dscp <0-63></pre> - Set the DSCP filtering by specifying a value for DSCP. <pre>precedence <0-7></pre> - Set the cos value and the cos mask for a packet. <pre>shutdown</pre> - Disable the Ethernet interface. <pre>any</pre> - Any IP address (as source or destination).

	<p>Related Syntax:</p> <ul style="list-style-type: none"> ● <config-ip-acl >#deny <0-255> <A.B.C.D>/<A.B.C.D> <A.B.C.D>/<A.B.C.D> dscp <0-63> ● <config-ip-acl >#deny <0-255> <A.B.C.D>/<A.B.C.D> <A.B.C.D>/<A.B.C.D> dscp <0-63> shutdown ● <config-ip-acl >#deny <0-255> <A.B.C.D>/<A.B.C.D> <A.B.C.D>/<A.B.C.D> precedence <0-7> ● <config-ip-acl >#deny <0-255> <A.B.C.D>/<A.B.C.D> <A.B.C.D>/<A.B.C.D> precedence <0-7> shutdown ● <config-ip-acl >#deny <0-255> any <A.B.C.D>/<A.B.C.D> dscp <0-63> ● <config-ip-acl >#deny <0-255> any <A.B.C.D>/<A.B.C.D> dscp <0-63> shutdown ● <config-ip-acl >#deny <0-255> any <A.B.C.D>/<A.B.C.D> precedence <0-7> ● <config-ip-acl >#deny <0-255> any <A.B.C.D>/<A.B.C.D> precedence <0-7> shutdown ● <config-ip-acl >#deny <0-255> any any dscp <0-7> ● <config-ip-acl >#deny <0-255> any any dscp <0-7> shutdown ● <config-ip-acl >#deny <0-255> any any precedence <0-7> ● <config-ip-acl >#deny <0-255> any any precedence <0-7> shutdown
	<p>Use the “do” command to run execution command in current mode. <SEQUENCE> -</p> <p>Related Syntax:</p> <ul style="list-style-type: none"> ● <config-ip-acl>#do <SEQUENCE>
	<p>Use the “end” command to finish current mode. Any changes in current mode will be saved.</p> <p>Related Syntax:</p> <ul style="list-style-type: none"> ● <config-ip-acl>#end
	<p>Use the “exit” command to close the current CLI session or return to the previous mode without saving the settings.</p> <p>Related Syntax:</p> <ul style="list-style-type: none"> ● <config-ip-acl>#exit
	<p>Use the “no sequence” command to delete any entry in management ACL. <1-2147483647>- Specify an index number of the ACL.</p> <p>Related Syntax:</p> <ul style="list-style-type: none"> ● <config-ip-acl>#no sequence <1-2147483647>
	<p>Use the “permit” command to create permit rules which bypass the packets meet the rule. <0-255/egp/hmp/icmp/igp/ipinip/ipv6 /ipv6:frag /ipv6:icmp /ipv6:rout / ip / I2tp /ospf /pim / rdp / rsvp /tcp /udp > - Specify the IP protocol number or enter the name of the protocol. <A.B.C.D>/<A.B.C.D> <A.B.C.D>/<A.B.C.D> - Specify the source and destination IPv4 addresses and subnet masks. dscp <0-63> - Set the DSCP filtering by specifying a value for DSCP. precedence <0-7> - Set the cos value and the cos mask for a packet. Shutdown - Disable the Ethernet interface. any - Any IP address (as source or destination).</p> <p>Related Syntax:</p> <ul style="list-style-type: none"> ● <config-ip-acl >#permit <0-255> <A.B.C.D>/<A.B.C.D> <A.B.C.D>/<A.B.C.D> dscp <0-63> ● <config-ip-acl >#permit <0-255> <A.B.C.D>/<A.B.C.D> <A.B.C.D>/<A.B.C.D> dscp <0-63> shutdown

	<ul style="list-style-type: none"> ● <config-ip-acl >#permit <0-255> <A.B.C.D>/<A.B.C.D> <A.B.C.D>/<A.B.C.D> precedence <0-7> ● <config-ip-acl >#permit <0-255> <A.B.C.D>/<A.B.C.D> <A.B.C.D>/<A.B.C.D> precedence <0-7> shutdown ● <config-ip-acl >#permit <0-255> any <A.B.C.D>/<A.B.C.D> dscp <0-63> ● <config-ip-acl >#permit <0-255> any <A.B.C.D>/<A.B.C.D> dscp <0-63> shutdown ● <config-ip-acl >#permit <0-255> any <A.B.C.D>/<A.B.C.D> precedence <0-7> ● <config-ip-acl >#permit <0-255> any <A.B.C.D>/<A.B.C.D> precedence <0-7> shutdown ● <config-ip-acl >#permit <0-255> any any dscp <0-7> ● <config-ip-acl >#permit <0-255> any any dscp <0-7> shutdown ● <config-ip-acl >#permit <0-255> any any precedence <0-7> ● <config-ip-acl >#permit <0-255> any any precedence <0-7> shutdown <p>Use the "sequence" command to deny or permit the ACL. <1-2147483647> - Enter the sequence of ACL entry. The sequence represents the priority of the ACE in the ACL.</p> <p>Related Syntax:</p> <ul style="list-style-type: none"> ● <config-ip-acl >#sequence <1-2147483647> deny ● <config-ip-acl >#sequence <1-2147483647> permit <p>Use the "show acl" command to list current status of the selected ACL.</p>
<i>ip address</i>	<p>Use this command to modify the administration IPv4 address.</p> <p>address <A.B.C.D> - Specify the IPv4 addresses. This IP is required when the administrator wants to access into VigorSwitch through Telnet, SSH, HTTP, HTTPS, SNMP and so on.</p> <p>mask <A.B.C.D> - Specify the netmask of the IP address.</p> <p>Related Syntax:</p> <ul style="list-style-type: none"> ● <config>#ip address <A.B.C.D> ● <config>#ip address <A.B.C.D> mask <A.B.C.D>
<i>ip arp</i>	<p>Use this command to enable the function of dynamic ARP inspection.</p> <p>vlan <1-4094> - Specify the VLAN ID number.</p> <p>Related Syntax:</p> <ul style="list-style-type: none"> ● <config>#ip arp inspection ● <config>#ip arp inspection vlan <1-4094>
<i>ip conflict</i>	<p>Use this command to do IP conflict prevention.</p> <p>lag - Enable/disable the function.</p> <p><A.B.C.D> - Specify the IPv4 addresses.</p> <p><1-12> - Specify a physical port.</p> <p><1-8> - Specify a LAG port.</p> <p>Related Syntax:</p> <ul style="list-style-type: none"> ● <config>#ip conflict lag ● <config>#ip conflict prevention ● <config>#ip conflict prevention clear ● <config>#ip conflict prevention server-ip <A.B.C.D> interface Gigabitethernet <1-12> ● <config>#ip conflict prevention server-ip <A.B.C.D> interface LAG <1-8>
<i>ip default-gateway</i>	<p>Use this command to modify default gateway address.</p> <p>address <A.B.C.D> - Specify the IPv4 addresses.</p> <p>Related Syntax:</p>

	<ul style="list-style-type: none"> ● <config>#ip default-gateway <A.B.C.D>
<i>ip dhcp</i>	<p>Use this command to enable DHCP client to get IP address from remote DHCP server.</p> <p>database <flash/tftp/timeout/write-delay> - Write the database to FLASH or remote TFTP server. Set timeout interval for abortion. Set delay timer for writing to URL.</p> <p><A.B.C.D> - Specify the IPv4 addresses.</p> <p><HOSTNAME> - Enter the name of the host.</p> <p><NAME> - Set a name for the backup file.</p> <p><0-86400> - Enter a value. Unit is second.</p> <p><15-86400> - Enter a value. Unit is second.</p> <p>option - Configure DHCP-Option82 settings by specifying remote ID number.</p> <p><STRING> - Enter a string (from 1 to 63 characters) for the DHCP option.</p> <p>vlan - Configure VLAN settings.</p> <p><1-4094> - Specify the VLAN ID number.</p> <p>Related Syntax:</p> <ul style="list-style-type: none"> ● <config>#ip dhcp snooping ● <config>#ip dhcp snooping database ● <config>#ip dhcp snooping database flash ● <config>#ip dhcp snooping database tftp <A.B.C.D> ● <config>#ip dhcp snooping database tftp <HOSTNAME><NAME> ● <config>#ip dhcp snooping database timeout <0-86400> ● <config>#ip dhcp snooping database write-delay <15-86400> ● <config>#ip dhcp snooping option remote-id <STRING> ● <config>#ip dhcp snooping vlan <1-4094>
<i>ip dns</i>	<p>Use this command to modify DNS server configuration.</p> <p><A.B.C.D> - Specify the IP address as primary DNS server.</p> <p><A.B.C.D> <A.B.C.D> - Sepcify two IP addresses as primary and secondary DNS server.</p> <p><X:X:XX:X:X> - Specify the MAC address as primary DNS server.</p> <p><X:X:XX:X:X><X:X::X:X> - Specify two MAC addresses as primary and secondary DNS server.</p> <p>lookup - Enable the IP domain naming system lookup.</p> <p>Related Syntax:</p> <ul style="list-style-type: none"> ● <config>#ip dns <A.B.C.D> ● <config>#ip dns <A.B.C.D> <A.B.C.D> ● <config>#ip dns <X:X:XX:X:X> ● <config>#ip dns <X:X:XX:X:X><X:X::X:X> ● <config>#ip dns lookup
<i>ip forcedhttps</i>	<p>Use this command to enable the function of forced HTTPS configuration.</p> <p>Related Syntax:</p> <ul style="list-style-type: none"> ● <config>#ip forcedhttps
<i>ip http</i>	<p>Use this command to enable the function of HTTP configuration.</p> <p>Login - Set login authentication.</p> <p><LISTNAME> - Enter the authentication method list name.</p> <p>Session-timeout - Set the session timeout.</p> <p><0-86400> - Set the timeout value. 0 means no timeout.</p> <p>Related Syntax:</p> <ul style="list-style-type: none"> ● <config>#ip http login authentication <LISTNAME>

	<ul style="list-style-type: none"> ● <config>#ip http session-timeout <0-86400>
<i>ip https</i>	<p>Use this command to enable the function of HTTPS configuration. Login - Set login authentication. <LISTNAME> - Enter the authentication method list name. Session-timeout - Set the session timeout. <0-86400> - Set the timeout value. 0 means no timeout.</p> <p>Related Syntax:</p> <ul style="list-style-type: none"> ● <config>#ip https login authentication <LISTNAME> ● <config>#ip https session-timeout <0-86400>
<i>ip igmp</i>	<p>Use this command to set IGMP profile and enable IGMP snooping function. Profile - Set IGMP profile. <1-128> - Enter the index number of IGMP profile to access into next phase for configuring detailed settings. <A.B.C.D><A.B.C.D> - Specify the source and destination IPv4 addresses action <deny/permit> - Speicfy the rule (deny/permit) for the IGMP profile.</p> <p>Related Syntax:</p> <ul style="list-style-type: none"> ● <config>#ip igmp profile <1-128> <config-igmp-profile># do <config-igmp-profile># end <config-igmp-profile># exit <config-igmp-profile># profile range ip <A.B.C.D><A.B.C.D> <config-igmp-profile># profile range ip <A.B.C.D><A.B.C.D> action <deny/permit> <config-igmp-profile># profile range ip <A.B.C.D> action <deny/permit> <config-igmp-profile># show ● <config>#ip igmp snooping
<i>ip source</i>	<p>Use this command to create a static IP source binding entry. <A:B:C:D:E:F> - Enter the MAC address for the binding entry. vlan <1-4094> - Specify the VLAN ID number. <A.B.C.D><A.B.C.D> - Specify the source and destination IPv4 addresses <1-12> - Specify a physical port. <1-8> - Specify a LAG port.</p> <p>Related Syntax:</p> <ul style="list-style-type: none"> ● <config>#ip source binding <A:B:C:D:E:F> vlan <1-4094> <A.B.C.D> <A.B.C.D> interface Gigabitethernet <1-12> ● <config>#ip source binding <A:B:C:D:E:F> vlan <1-4094> <A.B.C.D> <A.B.C.D> interface LAG <1-8> ● <config>#ip source binding vlan <1-4094> <A.B.C.D> <A.B.C.D> interface Gigabitethernet <1-12> ● <config>#ip source binding vlan <1-4094> <A.B.C.D> <A.B.C.D> interface LAG <1-8>
<i>ip ssh</i>	<p>Use this command to generate the key files for SSH connection. <all/v1/v2> - Select the key files for SSH connection.</p> <p>Related Syntax:</p> <ul style="list-style-type: none"> ● <config>#ip ssh <all/v1/v2>
<i>ip telnet</i>	<p>Use this command to enable telent service.</p> <p>Related Syntax:</p> <ul style="list-style-type: none"> ● <config>#ip telnet

Example

```
P2121# configure
P2121(config)# ip acl market_1
P2121(config-ip-acl)#
P2121(config-ip-acl)# deny 20 192.168.2.55/255.255.255.0 192.168.2.85/255
P2121(config)# ip dhcp snooping database tftp draytek carrie_backup
```

Telnet Command: ipv6

Use this command to create an IPv6 access list (ACL).

Syntax Items

ipv6
ipv6 acl
ipv6 address
ipv6 autoconfig
ipv6 default-gateway
ipv6 dhcp
ipv6 mld

Description

Syntax Items	Description
<i>ipv6 acl</i>	<p><NAME> - Set the name of the access list (ACL) based on IPv6. To configure detailed settings, enter the name of ACL to access into next level. <config>#ipv6 acl <NAME> Then, available sub-command includes: <config-ipv6-acl>#deny <config-ipv6-acl>#do <config-ipv6-acl>#end <config-ipv6-acl>#exit <config-ipv6-acl>#no <config-ipv6-acl>#permit <config-ipv6-acl>#sequence <config-ipv6-acl>#show</p> <hr/> <p>Use the "deny" command to create deny rules for the IPv4 access list. <0-255/icmp/ipv6/tcp /udp > - Specify the IP protocol number or enter the name of the protocol. <0-255/any> - Specify ICMPv6 number. <X::X:X>/<0-128> <X::X:X>/<0-128> - Specify the source/destination IPv6 addresses and subnet masks. dscp <0-63> - Set the DSCP filtering by specifying a value for DSCP. precedence <0-7> - Set the cos value and the cos mask for a packet. shutdown - Disable the Ethernet interface. any - Any IP address (as source or destination). <0-65535 / PORT_RANGE / any / daytime / discard / domain / drip / echo / ftp / ftp-data / hostname / klogin / kshell / pop2 / pop3 / smtp / sunrpc / syslog / tacacs-ds / talk / telnet / time / whois / www> <X::X:X>/<0-128> <0-65535 / PORT_RANGE / any / daytime / discard / domain / drip / echo / ftp / ftp-data / hostname / klogin / kshell / pop2 / pop3 / smtp / sunrpc / syslog / tacacs-ds /</p>

talk / telnet / time / whois / www> - Set TCP port.

match-all <TCP_FLAG> - Set TCP flags. List of TCP flags that should occur. If a flag should be set, it is p refixed by "+". If a flag should be unset, it is prefixed by "-". Available options are +urg, +ack, +psh, +rst, +syn, +fin, -urg, -ack, -psh, -rst, -syn and -fin. To define more than 1 flag - enter additional flags one after another without a space (example +syn-ack).

<0-65535/ PORT_RANGE / any / bootpc / bootps / discard / domain / echo / nameserver / netbios-ns / ntp / rip / snmp / snmptrap / sunrpc / syslog / tacacs-ds / talk / tftp / time / who>
 <X::X:X>/<0-128> <0-65535/ PORT_RANGE / any / bootpc / bootps / discard / domain / echo / nameserver / netbios-ns / ntp / rip / snmp / snmptrap / sunrpc / syslog / tacacs-ds / talk / tftp / time / who> - Set UDP port.

Related Syntax:

- <config-ipv6-acl >#deny <0-255> <X::X:X>/<0-128>
 <X::X:X>/<0-128>
- <config-ipv6-acl >#deny <0-255> <X::X:X>/<0-128>
 <X::X:X>/<0-128> dscp <0-63>
- <config-ipv6-acl >#deny <0-255> <X::X:X>/<0-128>
 <X::X:X>/<0-128> dscp <0-63> shutdown
- <config-ipv6-acl >#deny <0-255> <X::X:X>/<0-128>
 <X::X:X>/<0-128> precedence <0-7>
- <config-ipv6-acl >#deny <0-255> <X::X:X>/<0-128>
 <X::X:X>/<0-128> precedence <0-7> shutdown
- <config-ipv6-acl >#deny <0-255> <X::X:X>/<0-128>
 <X::X:X>/<0-128> shutdown
- <config-ipv6-acl >#deny <0-255> <X::X:X>/<0-128> any dscp
 <0-63>
- <config-ipv6-acl >#deny <0-255> <X::X:X>/<0-128> any dscp
 <0-63> shutdown
- <config-ipv6-acl >#deny <0-255> <X::X:X>/<0-128> any
 precedence <0-7>
- <config-ipv6-acl >#deny <0-255> <X::X:X>/<0-128> any
 precedence <0-7>shutdown
- <config-ipv6-acl >#deny <0-255> <X::X:X>/<0-128> any
 shutdown
- <config-ipv6-acl >deny icmp <X::X:X>/<0-128>
 <X::X:X>/<0-128> <0-255 / any / destination-unreachable /
 echo-reply / echo-request / nd-na / nd-ns / packet-too-big/
 parameter-problem/ router-advertisement /
 router-solicitation / time-exceeded> <0-255/any> dscp <0-63>
- <config-ipv6-acl >#deny icmp <X::X:X>/<0-128>
 <X::X:X>/<0-128><0-255 / any / destination-unreachable /
 echo-reply / echo-request / nd-na / nd-ns / packet-too-big/
 parameter-problem/ router-advertisement /
 router-solicitation / time-exceeded> <0-255/any> dscp <0-63>
 shutdown
- <config-ipv6-acl >#deny icmp <X::X:X>/<0-128>
 <X::X:X>/<0-128><0-255 / any / destination-unreachable /
 echo-reply / echo-request / nd-na / nd-ns / packet-too-big/
 parameter-problem/ router-advertisement /
 router-solicitation / time-exceeded> <0-255/any> precedence
 <0-7>
- <config-ipv6-acl >#deny icmp <X::X:X>/<0-128>
 <X::X:X>/<0-128><0-255 / any / destination-unreachable /
 echo-reply / echo-request / nd-na / nd-ns / packet-too-big/
 parameter-problem/ router-advertisement /
 router-solicitation / time-exceeded> <0-255/any> precedence
 <0-7> shutdown
- <config-ipv6-acl >#deny icmp <X::X:X>/<0-128>
 <X::X:X>/<0-128><0-255 / any / destination-unreachable /
 echo-reply / echo-request / nd-na / nd-ns / packet-too-big/
 parameter-problem/ router-advertisement /

-
- router-solicitation / time-exceeded> <0-255/any> shutdown
 - <config-ipv6-acl >#deny icmp <X::X:X>/<0-128> any <0-255 / any / destination-unreachable / echo-reply / echo-request / nd-na / nd-ns / packet-too-big/ parameter-problem/ router-advertisement / router-solicitation / time-exceeded> <0-255 /any> dscp <0-63>
 - <config-ipv6-acl >#deny icmp <X::X:X>/<0-128> any <0-255 / any / destination-unreachable / echo-reply / echo-request / nd-na / nd-ns / packet-too-big/ parameter-problem/ router-advertisement / router-solicitation / time-exceeded> <0-255 /any> dscp <0-63> shutdown
 - <config-ipv6-acl >#deny icmp <X::X:X>/<0-128> any <0-255 / any / destination-unreachable / echo-reply / echo-request / nd-na / nd-ns / packet-too-big/ parameter-problem/ router-advertisement / router-solicitation / time-exceeded> <0-255 /any> precedence <0-7>
 - <config-ipv6-acl >#deny icmp <X::X:X>/<0-128> any <0-255 / any / destination-unreachable / echo-reply / echo-request / nd-na / nd-ns / packet-too-big/ parameter-problem/ router-advertisement / router-solicitation / time-exceeded> <0-255 /any> precedence <0-7> shutdown
 - <config-ipv6-acl >#deny icmp <X::X:X>/<0-128> any <0-255 / any / destination-unreachable / echo-reply / echo-request / nd-na / nd-ns / packet-too-big/ parameter-problem/ router-advertisement / router-solicitation / time-exceeded> <0-255 /any> shutdown
 - <config-ipv6-acl >#deny ipv6 <X::X:X>/<0-128> <X::X:X>/<0-128>
 - <config-ipv6-acl >#deny ipv6 <X::X:X>/<0-128> <X::X:X>/<0-128> dscp <0-63>
 - <config-ipv6-acl >#deny ipv6 <X::X:X>/<0-128> <X::X:X>/<0-128> dscp <0-63> shutdown
 - <config-ipv6-acl >#deny ipv6 <X::X:X>/<0-128> <X::X:X>/<0-128> precedence <0-7>
 - <config-ipv6-acl >#deny ipv6 <X::X:X>/<0-128> <X::X:X>/<0-128> precedence <0-7> shutdown
 - <config-ipv6-acl >#deny ipv6 <X::X:X>/<0-128> <X::X:X>/<0-128> shutdown
 - <config-ipv6-acl >#deny ipv6 <X::X:X>/<0-128> any dscp <0-63>
 - <config-ipv6-acl >#deny ipv6 <X::X:X>/<0-128> any dscp <0-63> shutdown
 - <config-ipv6-acl >#deny ipv6 <X::X:X>/<0-128> any precedence <0-7>
 - <config-ipv6-acl >#deny ipv6 <X::X:X>/<0-128> any precedence <0-7>shutdown
 - <config-ipv6-acl >#deny ipv6 <X::X:X>/<0-128> any shutdown
 - <config-ipv6-acl >#deny ipv6 any <X::X:X>/<0-128>
 - <config-ipv6-acl >#deny ipv6 any <X::X:X>/<0-128> dscp <0-63>
 - <config-ipv6-acl >#deny ipv6 any <X::X:X>/<0-128> dscp <0-63> shutdown
 - <config-ipv6-acl >#deny ipv6 any <X::X:X>/<0-128> precedence <0-7>
 - <config-ipv6-acl >#deny ipv6 any <X::X:X>/<0-128> precedence <0-7> shutdown
 - <config-ipv6-acl >#deny ipv6 any <X::X:X>/<0-128> shutdown
 - <config-ipv6-acl >#deny ipv6 any any
 - <config-ipv6-acl >#deny ipv6 any any dscp <0-63>
 - <config-ipv6-acl >#deny ipv6 any any dscp <0-63> shutdown
 - <config-ipv6-acl >#deny ipv6 any any precedence <0-7>
 - <config-ipv6-acl >#deny ipv6 any any precedence <0-7> shutdown
-

```
smtp / sunrpc / syslog / tacacs-ds / talk / telnet / time / whois / www> <X::X:X>/<0-128> <0-65535 / PORT_RANGE / any / daytime / discard / domain / drip / echo / ftp / ftp-data / hostname / klogin / kshell / pop2 / pop3 / smtp / sunrpc / syslog / tacacs-ds / talk / telnet / time / whois / www> match-all <TCP_FLAG> shutdown
```

- <config-ipv6-acl >#deny tcp <X::X:X>/<0-128> <0-65535 / PORT_RANGE / any / daytime / discard / domain / drip / echo / ftp / ftp-data / hostname / klogin / kshell / pop2 / pop3 / smtp / sunrpc / syslog / tacacs-ds / talk / telnet / time / whois / www> <X::X:X>/<0-128> <0-65535 / PORT_RANGE / any / daytime / discard / domain / drip / echo / ftp / ftp-data / hostname / klogin / kshell / pop2 / pop3 / smtp / sunrpc / syslog / tacacs-ds / talk / telnet / time / whois / www> precedence <0-7>
 - <config-ipv6-acl >#deny tcp <X::X:X>/<0-128> <0-65535 / PORT_RANGE / any / daytime / discard / domain / drip / echo / ftp / ftp-data / hostname / klogin / kshell / pop2 / pop3 / smtp / sunrpc / syslog / tacacs-ds / talk / telnet / time / whois / www> <X::X:X>/<0-128> <0-65535 / PORT_RANGE / any / daytime / discard / domain / drip / echo / ftp / ftp-data / hostname / klogin / kshell / pop2 / pop3 / smtp / sunrpc / syslog / tacacs-ds / talk / telnet / time / whois / www> precedence <0-7> shutdown
 - <config-ipv6-acl >#deny tcp <X::X:X>/<0-128> <0-65535 / PORT_RANGE / any / daytime / discard / domain / drip / echo / ftp / ftp-data / hostname / klogin / kshell / pop2 / pop3 / smtp / sunrpc / syslog / tacacs-ds / talk / telnet / time / whois / www> <X::X:X>/<0-128> <0-65535 / PORT_RANGE / any / daytime / discard / domain / drip / echo / ftp / ftp-data / hostname / klogin / kshell / pop2 / pop3 / smtp / sunrpc / syslog / tacacs-ds / talk / telnet / time / whois / www> shutdown
 - <config-ipv6-acl >#deny udp <X::X:X>/<0-128> <0-65535/ PORT_RANGE / any / bootpc / bootps / discard / domain / echo / nameserver / netbios-ns / ntp / rip / snmp / snmptrap / sunrpc / syslog / tacacs-ds / talk / tftp / time / who> <X::X:X>/<0-128> <0-65535/ PORT_RANGE / any / bootpc / bootps / discard / domain / echo / nameserver / netbios-ns / ntp / rip / snmp / snmptrap / sunrpc / syslog / tacacs-ds / talk / tftp / time / who>
 - <config-ipv6-acl >#deny udp <X::X:X>/<0-128> <0-65535/ PORT_RANGE / any / bootpc / bootps / discard / domain / echo / nameserver / netbios-ns / ntp / rip / snmp / snmptrap / sunrpc / syslog / tacacs-ds / talk / tftp / time / who> dscp <0-63>
 - <config-ipv6-acl >#deny udp <X::X:X>/<0-128> <0-65535/ PORT_RANGE / any / bootpc / bootps / discard / domain / echo / nameserver / netbios-ns / ntp / rip / snmp / snmptrap / sunrpc / syslog / tacacs-ds / talk / tftp / time / who> dscp <0-63> shutdown
 - <config-ipv6-acl >#deny udp <X::X:X>/<0-128> <0-65535/ PORT_RANGE / any / bootpc / bootps / discard / domain / echo / nameserver / netbios-ns / ntp / rip / snmp / snmptrap / sunrpc / syslog / tacacs-ds / talk / tftp / time / who> <X::X:X>/<0-128> <0-65535/ PORT_RANGE / any / bootpc / bootps / discard / domain / echo / nameserver / netbios-ns / ntp / rip / snmp / snmptrap / sunrpc / syslog / tacacs-ds / talk / tftp / time / who> dscp <0-63> precedence <0-7>
 - <config-ipv6-acl >#deny udp <X::X:X>/<0-128> <0-65535/
-

<p>PORT_RANGE / any / bootpc / bootps / discard / domain / echo / nameserver / netbios-ns / ntp / rip / snmp / snmptrap / sunrpc / syslog / tacacs-ds / talk / tftp / time / who> <X::X:X>/<0-128> <0-65535/ PORT_RANGE / any / bootpc / bootps / discard / domain / echo / nameserver / netbios-ns / ntp / rip / snmp / snmptrap / sunrpc / syslog / tacacs-ds / talk / tftp / time / who> dscp <0-63> precedence <0-7> shutdown</p> <ul style="list-style-type: none"> ● <config-ipv6-acl >#deny udp <X::X:X>/<0-128> <0-65535> any
<p>Use the “do” command to run execution command in current mode. <SEQUENCE> -</p> <p>Related Syntax:</p> <ul style="list-style-type: none"> ● <config-ipv6-acl>#do <SEQUENCE>
<p>Use the “end” command to finish current mode. Any changes in current mode will be saved.</p> <p>Related Syntax:</p> <ul style="list-style-type: none"> ● <config-ipv6-acl>#end
<p>Use the “exit” command to close the current CLI session or return to the previous mode without saving the settings.</p> <p>Related Syntax:</p> <ul style="list-style-type: none"> ● <config-ipv6-acl>#exit
<p>Use the “no sequence” command to delete any entry in management ACL. <1-2147483647>- Specify an index number of the ACL.</p> <p>Related Syntax:</p> <ul style="list-style-type: none"> ● <config-ip-acl>#no sequence <1-2147483647>
<p>Use the “permit” command to create permit rules which bypass the packets meet the rule.</p> <p><0-255/icmp/ipv6/tcp /udp > - Specify the IP protocol number or enter the name of the protocol. <0-255/any> - Specify ICMPv6 number. <X::X:X>/<0-128> <X::X:X>/<0-128> - Specify the source/destination IPv6 addresses and subnet masks. dscp <0-63> - Set the DSCP filtering by specifying a value for DSCP. precedence <0-7> - Set the cos value and the cos mask for a packet. shutdown - Disable the Ethernet interface. any - Any IP address (as source or destination). <0-65535 / PORT_RANGE / any / daytime / discard / domain / drip / echo / ftp / ftp-data / hostname / klogin / kshell / pop2 / pop3 / smtp / sunrpc / syslog / tacacs-ds / talk / telnet / time / whois / www> <X::X:X>/<0-128> <0-65535 / PORT_RANGE / any / daytime / discard / domain / drip / echo / ftp / ftp-data / hostname / klogin / kshell / pop2 / pop3 / smtp / sunrpc / syslog / tacacs-ds / talk / telnet / time / whois / www> - Set TCP port. match-all <TCP_FLAG> - Set TCP flags. List of TCP flags that should occur. If a flag should be set, it is p refixed by "+". If a flag should be unset, it is prefixed by "-". Available options are +urg, +ack, +psh, +rst, +syn, +fin, -urg, -ack, -psh, -rst, -syn and -fin. To define more than 1 flag - enter additional flags one after another without a space (example +syn-ack). <0-65535/ PORT_RANGE / any / bootpc / bootps / discard / domain / echo / nameserver / netbios-ns / ntp / rip / snmp / snmptrap / sunrpc / syslog / tacacs-ds / talk / tftp / time / who> <X::X:X>/<0-128> <0-65535/ PORT_RANGE / any / bootpc / bootps / discard / domain / echo / nameserver / netbios-ns / ntp / rip / snmp / snmptrap / sunrpc / syslog / tacacs-ds / talk / tftp / time / who> - Set UDP port.</p> <p>Related Syntax:</p> <ul style="list-style-type: none"> ● <config-ipv6-acl >#permit <0-255> <X::X:X>/<0-128>

<X::X:X>/<0-128>

- <config-ipv6-acl ># permit <0-255> <X::X:X>/<0-128>
<X::X:X>/<0-128> dscp <0-63>
 - <config-ipv6-acl ># permit <0-255> <X::X:X>/<0-128>
<X::X:X>/<0-128> dscp <0-63> shutdown
 - <config-ipv6-acl ># permit <0-255> <X::X:X>/<0-128>
<X::X:X>/<0-128> precedence <0-7>
 - <config-ipv6-acl ># permit <0-255> <X::X:X>/<0-128>
<X::X:X>/<0-128> precedence <0-7> shutdown
 - <config-ipv6-acl ># permit <0-255> <X::X:X>/<0-128>
<X::X:X>/<0-128> shutdown
 - <config-ipv6-acl ># permit <0-255> <X::X:X>/<0-128> any
dscp <0-63>
 - <config-ipv6-acl ># permit <0-255> <X::X:X>/<0-128> any
dscp <0-63> shutdown
 - <config-ipv6-acl ># permit <0-255> <X::X:X>/<0-128> any
precedence <0-7>
 - <config-ipv6-acl ># permit <0-255> <X::X:X>/<0-128> any
precedence <0-7>shutdown
 - <config-ipv6-acl ># permit <0-255> <X::X:X>/<0-128> any
shutdown
 - <config-ipv6-acl > permit icmp <X::X:X>/<0-128>
<X::X:X>/<0-128> <0-255 / any / destination-unreachable /
echo-reply / echo-request / nd-na / nd-ns / packet-too-big/
parameter-problem/ router-advertisement /
router-solicitation / time-exceeded> <0-255/any> dscp <0-63>
 - <config-ipv6-acl ># permit icmp <X::X:X>/<0-128>
<X::X:X>/<0-128><0-255 / any / destination-unreachable /
echo-reply / echo-request / nd-na / nd-ns / packet-too-big/
parameter-problem/ router-advertisement /
router-solicitation / time-exceeded> <0-255/any> dscp <0-63>
shutdown
 - <config-ipv6-acl ># permit icmp <X::X:X>/<0-128>
<X::X:X>/<0-128><0-255 / any / destination-unreachable /
echo-reply / echo-request / nd-na / nd-ns / packet-too-big/
parameter-problem/ router-advertisement /
router-solicitation / time-exceeded> <0-255/any> precedence
<0-7>
 - <config-ipv6-acl ># permit icmp <X::X:X>/<0-128>
<X::X:X>/<0-128><0-255 / any / destination-unreachable /
echo-reply / echo-request / nd-na / nd-ns / packet-too-big/
parameter-problem/ router-advertisement /
router-solicitation / time-exceeded> <0-255/any> precedence
<0-7> shutdown
 - <config-ipv6-acl ># permit icmp <X::X:X>/<0-128>
<X::X:X>/<0-128><0-255 / any / destination-unreachable /
echo-reply / echo-request / nd-na / nd-ns / packet-too-big/
parameter-problem/ router-advertisement /
router-solicitation / time-exceeded> <0-255/any> shutdown
 - <config-ipv6-acl ># permit icmp <X::X:X>/<0-128> any
<0-255 / any / destination-unreachable / echo-reply /
echo-request / nd-na / nd-ns / packet-too-big/
parameter-problem/ router-advertisement /
router-solicitation / time-exceeded> <0-255 /any> dscp <0-63>
 - <config-ipv6-acl ># permit icmp <X::X:X>/<0-128> any
<0-255 / any / destination-unreachable / echo-reply /
echo-request / nd-na / nd-ns / packet-too-big/
parameter-problem/ router-advertisement /
router-solicitation / time-exceeded> <0-255 /any> dscp <0-63>
shutdown
 - <config-ipv6-acl ># permit icmp <X::X:X>/<0-128> any
<0-255 / any / destination-unreachable / echo-reply /
echo-request / nd-na / nd-ns / packet-too-big/
parameter-problem/ router-advertisement /
-

router-solicitation / time-exceeded> <0-255 /any> precedence <0-7>

- <config-ipv6-acl ># permit icmp <X::X:X>/<0-128> any <0-255 / any / destination-unreachable / echo-reply / echo-request / nd-na / nd-ns / packet-too-big/ parameter-problem/ router-advertisement / router-solicitation / time-exceeded> <0-255 /any> precedence <0-7> shutdown
- <config-ipv6-acl ># permit icmp <X::X:X>/<0-128> any <0-255 / any / destination-unreachable / echo-reply / echo-request / nd-na / nd-ns / packet-too-big/ parameter-problem/ router-advertisement / router-solicitation / time-exceeded> <0-255 /any> shutdown
- <config-ipv6-acl ># permit ipv6 <X::X:X>/<0-128> <X::X:X>/<0-128>
- <config-ipv6-acl ># permit ipv6 <X::X:X>/<0-128> <X::X:X>/<0-128> dscp <0-63>
- <config-ipv6-acl ># permit ipv6 <X::X:X>/<0-128> <X::X:X>/<0-128> dscp <0-63> shutdown
- <config-ipv6-acl ># permit ipv6 <X::X:X>/<0-128> <X::X:X>/<0-128> precedence <0-7>
- <config-ipv6-acl ># permit ipv6 <X::X:X>/<0-128> <X::X:X>/<0-128> precedence <0-7> shutdown
- <config-ipv6-acl ># permit ipv6 <X::X:X>/<0-128> <X::X:X>/<0-128> shutdown
- <config-ipv6-acl ># permit ipv6 <X::X:X>/<0-128> any dscp <0-63>
- <config-ipv6-acl ># permit ipv6 <X::X:X>/<0-128> any dscp <0-63> shutdown
- <config-ipv6-acl ># permit ipv6 <X::X:X>/<0-128> any precedence <0-7>
- <config-ipv6-acl ># permit ipv6 <X::X:X>/<0-128> any precedence <0-7>shutdown
- <config-ipv6-acl ># permit ipv6 <X::X:X>/<0-128> any shutdown
- <config-ipv6-acl ># permit ipv6 any <X::X:X>/<0-128>
- <config-ipv6-acl ># permit ipv6 any <X::X:X>/<0-128> dscp <0-63>
- <config-ipv6-acl ># permit ipv6 any <X::X:X>/<0-128> dscp <0-63> shutdown
- <config-ipv6-acl ># permit ipv6 any <X::X:X>/<0-128> precedence <0-7>
- <config-ipv6-acl ># permit ipv6 any <X::X:X>/<0-128> precedence <0-7> shutdown
- <config-ipv6-acl ># permit ipv6 any <X::X:X>/<0-128> shutdown
- <config-ipv6-acl ># permit ipv6 any any
- <config-ipv6-acl ># permit ipv6 any any dscp <0-63>
- <config-ipv6-acl ># permit ipv6 any any dscp <0-63> shutdown
- <config-ipv6-acl ># permit ipv6 any any precedence <0-7>
- <config-ipv6-acl ># permit ipv6 any any precedence <0-7> shutdown
- <config-ipv6-acl ># permit ipv6 any any shutdown
- <config-ipv6-acl ># permit tcp <X::X:X>/<0-128> <0-65535 / PORT_RANGE / any / daytime / discard / domain / drip / echo / ftp / ftp-data / hostname / klogin / kshell / pop2 / pop3 / smtp / sunrpc / syslog / tacacs-ds / talk / telnet / time / whois / www> <X::X:X>/<0-128> <0-65535 / PORT_RANGE / any / daytime / discard / domain / drip / echo / ftp / ftp-data / hostname / klogin / kshell / pop2 / pop3 / smtp / sunrpc / syslog / tacacs-ds / talk / telnet / time / whois / www>
- <config-ipv6-acl ># permit tcp <X::X:X>/<0-128> <0-65535 / PORT_RANGE / any / daytime / discard / domain / drip / echo

daytime / discard / domain / drip / echo / ftp / ftp-data /
hostname / klogin / kshell / pop2 / pop3 / smtp / sunrpc /
syslog / tacacs-ds / talk / telnet / time / whois / www>
precedence <0-7>

- <config-ipv6-acl ># permit tcp <X:X::X:X>/<0-128> <0-65535 /
PORT_RANGE / any / daytime / discard / domain / drip / echo
/ ftp / ftp-data / hostname / klogin / kshell / pop2 / pop3 /
smtp / sunrpc / syslog / tacacs-ds / talk / telnet / time / whois
/ www> <X:X::X:X>/<0-128> <0-65535 / PORT_RANGE / any /
daytime / discard / domain / drip / echo / ftp / ftp-data /
hostname / klogin / kshell / pop2 / pop3 / smtp / sunrpc /
syslog / tacacs-ds / talk / telnet / time / whois / www>
precedence <0-7> shutdown
- <config-ipv6-acl ># permit tcp <X:X::X:X>/<0-128> <0-65535 /
PORT_RANGE / any / daytime / discard / domain / drip / echo
/ ftp / ftp-data / hostname / klogin / kshell / pop2 / pop3 /
smtp / sunrpc / syslog / tacacs-ds / talk / telnet / time / whois
/ www> <X:X::X:X>/<0-128> <0-65535 / PORT_RANGE / any /
daytime / discard / domain / drip / echo / ftp / ftp-data /
hostname / klogin / kshell / pop2 / pop3 / smtp / sunrpc /
syslog / tacacs-ds / talk / telnet / time / whois / www>
shutdown
- <config-ipv6-acl ># permit udp <X:X::X:X>/<0-128> <0-65535/
PORT_RANGE / any / bootpc / bootps / discard / domain / echo
/ nameserver / netbios-ns / ntp / rip / snmp / snmptrap /
sunrpc / syslog / tacacs-ds / talk / tftp / time / who>
<X:X::X:X>/<0-128> <0-65535/ PORT_RANGE / any / bootpc /
bootps / discard / domain / echo / nameserver / netbios-ns /
ntp / rip / snmp / snmptrap / sunrpc / syslog / tacacs-ds / talk
/ tftp / time / who>
- <config-ipv6-acl ># permit udp <X:X::X:X>/<0-128> <0-65535/
PORT_RANGE / any / bootpc / bootps / discard / domain / echo
/ nameserver / netbios-ns / ntp / rip / snmp / snmptrap /
sunrpc / syslog / tacacs-ds / talk / tftp / time / who>
<X:X::X:X>/<0-128> <0-65535/ PORT_RANGE / any / bootpc /
bootps / discard / domain / echo / nameserver / netbios-ns /
ntp / rip / snmp / snmptrap / sunrpc / syslog / tacacs-ds / talk
/ tftp / time / who> dscp <0-63>
- <config-ipv6-acl ># permit udp <X:X::X:X>/<0-128> <0-65535/
PORT_RANGE / any / bootpc / bootps / discard / domain / echo
/ nameserver / netbios-ns / ntp / rip / snmp / snmptrap /
sunrpc / syslog / tacacs-ds / talk / tftp / time / who>
<X:X::X:X>/<0-128> <0-65535/ PORT_RANGE / any / bootpc /
bootps / discard / domain / echo / nameserver / netbios-ns /
ntp / rip / snmp / snmptrap / sunrpc / syslog / tacacs-ds / talk
/ tftp / time / who> dscp <0-63> shutdown
- <config-ipv6-acl ># permit udp <X:X::X:X>/<0-128> <0-65535/
PORT_RANGE / any / bootpc / bootps / discard / domain / echo
/ nameserver / netbios-ns / ntp / rip / snmp / snmptrap /
sunrpc / syslog / tacacs-ds / talk / tftp / time / who>
<X:X::X:X>/<0-128> <0-65535/ PORT_RANGE / any / bootpc /
bootps / discard / domain / echo / nameserver / netbios-ns /
ntp / rip / snmp / snmptrap / sunrpc / syslog / tacacs-ds / talk
/ tftp / time / who> dscp <0-63> precedence <0-7>
- <config-ipv6-acl ># permit udp <X:X::X:X>/<0-128> <0-65535/
PORT_RANGE / any / bootpc / bootps / discard / domain / echo
/ nameserver / netbios-ns / ntp / rip / snmp / snmptrap /
sunrpc / syslog / tacacs-ds / talk / tftp / time / who>
<X:X::X:X>/<0-128> <0-65535/ PORT_RANGE / any / bootpc /
bootps / discard / domain / echo / nameserver / netbios-ns /
ntp / rip / snmp / snmptrap / sunrpc / syslog / tacacs-ds / talk
/ tftp / time / who> dscp <0-63> precedence <0-7> shutdown
- <config-ipv6-acl ># permit udp <X:X::X:X>/<0-128> <0-65535>
any

Use the "sequence" command to deny or permit the ACL.

	<p><1-2147483647> - Enter the sequence of ACL entry. The sequence represents the priority of the ACE in the ACL.</p> <p>Related Syntax:</p> <ul style="list-style-type: none"> ● <config-ipv6-acl >#sequence <1-2147483647> deny ● <config-ipv6-acl >#sequence <1-2147483647> permit <p>Use the "show acl" command to list current status of the selected ACL.</p>
<i>ipv6 address</i>	<p>Use this command to modify the administration IPv6 address.</p> <p>address <X:X::X:X> - Specify the IPv6 addresses. This IP is required when the administrator wants to access into VigorSwitch through Telnet, SSH, HTTP, HTTPS, SNMP and so on.</p> <p>prefix <0-128> - Specify the prefix length of the IPv6 address.</p> <p>Related Syntax:</p> <ul style="list-style-type: none"> ● <config>#ipv6 address <X:X::X:X> prefix <0-128>
<i>ipv6 autoconfig</i>	Use this command to enable IPv6 auto configuration feature.
<i>ipv6 default-gateway</i>	<p>Use this command to modify default gateway address.</p> <p>default-address <X:X::X:X> - Specify the IPv6 addresses of the gateway.</p> <p>Related Syntax:</p> <ul style="list-style-type: none"> ● <config>#ipv6 default-gateway <X:X::X:X>
<i>ipv6 dhcp</i>	Use this command to enable DHCPv6 client to get IP address from remote DHCPv6 server.
<i>ipv6 mld</i>	<p>Use this command to set MLD configuration.</p> <p>profile <1-128> - Use it to enter profile configuration.</p> <p>snooping - Use it to enable MLD snooping function.</p> <p>forward-method <dip/mac> -</p> <p>report-suppression - Use it to enable MLD snooping report-suppression function.</p> <p>unknown-multicast action <drop/flood/router-port> - Use it to set unknown multicast action.</p> <p>version <1/2> - Use it to change MLD support version.</p> <p>vlan <1-4094> - Use it to enable MLD on VLAN. Specify a VLAN ID for configuration.</p> <p>forbidden-port GigabitEthernet <1-12> - Specify a physical port.</p> <p>forbidden-port LAG <1-8> - Specify a LAG port.</p> <p>forbidden-router-port GigabitEthernet <1-12> - Use it to add static forbidden router port. Specify a physical port.</p> <p>forbidden-router-port LAG <1-8> - Use it to add static forbidden router port. Specify a LAG port.</p> <p>immediate-leave - Use it to enable fastleave function.</p> <p>last-member-query-count <1-7> - Use it to change how many query packets will send. Specify the last member query count. Default is 2.</p> <p>last-member-query-interval <1-25> - Use it to set interval between each query packet. Specify the last member query interval. Default is 1.</p> <p>query-interval <30-18000> - Use it to set interval between each query. Specify the query interval. Default is 125.</p> <p>response-time <5-20> - Use it to set response time. Specify a time value. Default is 10.</p> <p>robustness-variable <1-7> - Specify a robustness-variable value. Default is 2.</p> <p>router learn pim-dvmrp - Use it to enable learning router port by routing protocol packets (DVMRP).</p> <p>static-group <X:X::X:X> interfaces gigabitethernet <1-12> - Use it to</p>

add a static group. Specify a physical port.

static-group <X:X:X> interfaces LAG <1-8> - Use it to add a static group. Specify a LAG port.

static-port gigabitethernet <1-12>- Use it to add static forwarding port. Specify a physical port.

static-port LAG <1-8>- Use it to add static forwarding port. Specify a LAG port.

static-router-port Gigabitethernet <1-12> - Use it to add static router port. All query packets wil forward to the specified port. Specify a physical port.

static-router-port LAG <1-8> - Use it to add static router port. All query packets wil forward to the specified port. Specify a LAG port.

Related Syntax:

- <config>#ipv6 mld profile <1-128>
 - <config-mld-profile># do
 - <config-mld-profile># end
 - <config-mld-profile># exit
 - <config-mld-profile># profile range ipv6 <X:X::X:X> action <deny/permit>
 - <config-mld-profile># profile range ipv6 <X:X::X:X> <X:X::X:X>
 - <config-mld-profile># profile range ipv6 <X:X::X:X> <X:X::X:X> action <deny/permit>
 - <config-mld-profile># show
- <config>#ipv6 mld snooping
- <config>#ipv6 mld snooping forward-method <dip/mac>
- <config>#ipv6 mld snooping report-suppression
- <config>#ipv6 mld snooping unknown-multicast action <drop/flood/router-port>
- <config>#ipv6 mld snooping version <1/2>
- <config>#ipv6 mld snooping vlan <1-4094>
- <config>#ipv6 mld snooping vlan <1-4094> forbidden-port Gigabitethernet <1-12>
- <config>#ipv6 mld snooping vlan <1-4094> forbidden-port LAG <1-8>
- <config>#ipv6 mld snooping vlan <1-4094> forbidden-router-port Gigabitethernet <1-12>
- <config>#ipv6 mld snooping vlan <1-4094> forbidden-router-port LAG <1-8>
- <config>#ipv6 mld snooping vlan <1-4094> immediate-leave
- <config>#ipv6 mld snooping vlan <1-4094> last-member-query-count <1-7>
- <config>#ipv6 mld snooping vlan <1-4094> last-member-query-interval <1-25>
- <config>#ipv6 mld snooping vlan <1-4094> query-interval <30-18000>
- <config>#ipv6 mld snooping vlan <1-4094> response-time <5-20>
- <config>#ipv6 mld snooping vlan <1-4094> robustness-variable <1-7>
- <config>#ipv6 mld snooping vlan <1-4094> router learn pim-dvmrp
- <config>#ipv6 mld snooping vlan <1-4094> static-group <X:X::X:X> interfaces gigabitethernet <1-12>
- <config>#ipv6 mld snooping vlan <1-4094> static-group <X:X::X:X> interfaces LAG <1-8>
- <config>#ipv6 mld snooping vlan <1-4094> static-port

	gigabitethernet <1-12> <ul style="list-style-type: none"> ● <config>#ipv6 mld snooping vlan <1-4094> static-port LAG <1-8> ● <config>#ipv6 mld snooping vlan <1-4094> static-router-port Gigabitethernet <1-12> ● <config>#ipv6 mld snooping vlan <1-4094> static-router-port LAG <1-8>
--	--

Example

```
P2121# configure
P2121(config)#
P2121(config)# ipv6 mld snooping vlan 33
P2121(config)# ipv6 acl CA_v6
P2121(config-ipv6-acl)# deny 3 00:50::32:ff/24 00:50::78:aa/32
```

Telnet Command: lacp

Use this command to set the system priority of the switch.

Syntax Items

lacp

lacp system-priority

Description

Syntax Items	Description
<i>lacp</i>	Enable the function.
<i>lacp system-priority</i>	It is used for selecting a master switch between two devices. Lower system priority has higher priority. The device with higher priority value can determine which port is able to join LAG. <1-65535> - Specify the system priority value. Related Syntax: <ul style="list-style-type: none"> ● <config># lacp ● <config># lacp system-priority <1-65535>

Example

```
P2121# configure
P2121(config)#
P2121(config)# lacp system-priority 1000
P2121(config)#
```

Telnet Command: lag

LAG port can transmit packets to all ports for balancing the traffic loading. Use this command to change the load balance algorithm to src-dst-mac or src-dst-mac-ip as the Load Balance policy.

Syntax Items

lag load-balance

Description

Syntax Items	Description
<i>lag load-balance</i>	LAG load balancing is based on source and destination MAC address and/or IP address. Related Syntax: <ul style="list-style-type: none"> ● <config># lag load-balance src-dst-mac ● <config># lag load-balance src-dst-mac-ip

Example

```
P2121# configure
P2121(config)#
```

Telnet Command: Ildp

Use this command to set LLDP function.

Syntax Items

Ildp
 Ildp holdtime-multiplier
 Ildp Ildpdu
 Ildp med
 Ildp reinit-delay
 Ildp tx-delay
 Ildp tx-interval

Description

Syntax Items	Description
<i>Ildp</i>	Enable the function of LLDP.
<i>Ildp holdtime-multiplier</i>	Set the multiplier used for calculating the LLDP discovery packet hold time. <2-10> - Set the LLDP hold time multiplier. Related Syntax: <ul style="list-style-type: none"> ● <config># Ildp holdtime-multiplier <2-10>
<i>Ildp Ildpdu</i>	bridging - The LLDP packets will be bridging when LLDP is disabled. filtering - The LLDP packets will be filtered and deleted when LLDP is disabled. flooding - The LLDP packets will be flooded and forwarded to all interfaces when LLDP is disabled. Related Syntax: <ul style="list-style-type: none"> ● <config># Ildp Ildpdu bridging ● <config># Ildp Ildpdu filtering ● <config># Ildp Ildpdu flooding
<i>Ildp med</i>	med fast-start-repeat-count - Set the LLDP PDU fast start TX repeat count. med network-policy - Set the LLDP MED network policy table. med network-poicy voice auto - Enable the network policy voice auto mode. <1-10> - Set the fast start repeat count. <1-32> - Specify the index number of the policy. app <guest-voice/ gust-voice-signaling / softphone-voice / streaming-video / video-conferencing / video-signaling / voice /

	<p>voice-signaling> - Configure the application type for the policy. vlan <1-4094> - Specify the VLAN ID. vlan-type <tag/untag> - Set the VLAN tag status. priority <0-7> - Specify the L2 priority. dscp <0-63> - Specify the DSCP value.</p> <p>Related Syntax:</p> <ul style="list-style-type: none"> ● <config># lldp med fast-start-repeat-count <1-10> ● <config># lldp med network-policy <1-32> app< guest-voice/ gust-voice-signaling / softphone-voice / streaming-video / video-conferencing / video-signaling / voice / voice-signaling > vlan <1-4094> vlan-type <tag/untag> priority <0-7> dscp <0-63> ● <config># lldp med network-poicy voice auto
<i>lldp rinit-delay</i>	<p>Set the LLDP re-initial delay to avoid LLDP generating too many PDU. <1-10> - Specify a number for LLDP server to initialize.</p> <p>Related Syntax:</p> <ul style="list-style-type: none"> ● <config># lldp rinit-delay <1-10>
<i>lldp tx-delay</i>	<p>Set the delay time between the successful LLDP frame transmissions. <1-8191> - Enter the number of delay time. Note that both tx-interval and tx-delay will affect the LLDP PDU TX time.</p> <p>Related Syntax:</p> <ul style="list-style-type: none"> ● <config># lldp tx-delay <1-8191>
<i>lldp tx-interval</i>	<p>Set the LLDP TX interval. <5-32767> - Enter the interval in unit of second.</p> <p>Related Syntax:</p> <ul style="list-style-type: none"> ● <config># lldp tx-interval <5-32767>

Example

```
P2121# configure
P2121(config)#
P2121(config)# lldp med network-policy 30 app guest-voice vlan 30 vlan-type
untag priority 3 dscp
P2121(config)#
```

Telnet Command: logging

Use this command to set logging service on VigorSwitch.

Syntax Items

logging

logging buffered

logging console

logging file

logging host

Description

Syntax Items	Description
--------------	-------------

<i>logging</i>	Enable the logging service.
<i>logging buffered</i>	Store the log message in the RAM.
<i>logging console</i>	Specify the logging level. <0-7> - Specify the logging level by entering a number (from EMEGR-DEBUG). Related Syntax: <ul style="list-style-type: none"> ● <config># logging console ● <config># logging console severity <0-7>
<i>logging file</i>	Store the log message in the flash. <0-7> - Specify the logging level by entering a number (from EMEGR-DEBUG). Related Syntax: <ul style="list-style-type: none"> ● <config># logging file severity <0-7>
<i>logging host</i>	Define the logging server. host <A.B.C.D> - Enter an IP address of the remote (or local) server. facility <local0-local7> - Specify the facility parameter for the syslog message. port <1-65535> - Enter a number for the remote server. Default is 514. severity <0-7> - Specify the logging level by entering a number (from EMEGR-DEBUG). <HOSTNAME> - Define a name as the host. Related Syntax: <ul style="list-style-type: none"> ● <config>#logging host <A.B.C.D> facility <local0-local7> ● <config>#logging host <A.B.C.D> port <1-65535> ● <config>#logging host <A.B.C.D> port <1-65535> facility <local0-local7> ● <config>#logging host <A.B.C.D> port <1-65535> severity <0-7> facility <local0-local7> ● <config>#logging host <A.B.C.D> severity <0-7> facility <local0-local7> ● <config>#logging host <HOSTNAME> facility <local0-local7> ● <config>#logging host <HOSTNAME> port <1-65535> ● <config>#logging host <HOSTNAME> port <1-65535> facility <local0-local7> ● <config>#logging host <HOSTNAME> port <1-65535> severity <0-7> facility <local0-local7> ● <config>#logging host <HOSTNAME> severity <0-7> facility <local0-local7> ● <config>#logging host <X:X::X:X> facility <local0-local7> ● <config>#logging host <X:X::X:X> port <1-65535> ● <config>#logging host <X:X::X:X> port <1-65535> facility <local0-local7> ● <config>#logging host <X:X::X:X> port <1-65535> severity <0-7> facility <local0-local7>

Example

```
P2121# configure
P2121(config)#
P2121(config)# logging host aa:00::1a:FF facility local1
```

Telnet Command: logmail

Use this command to configure log mail.

Syntax Items

logmail active
logmail auth
logmail category
logmail encry
logmail password
logmail port
logmail receiver
logmail sender
logmail server
logmail username

Description

Syntax Items	Description
<i>logmail active</i>	<disable/enable> - Enable or disable the function of log mail. Related Syntax: <ul style="list-style-type: none"> ● <config># logmail active <disable/enable>
<i>logmail auth</i>	<disable/enable> - Enable or disable the function of SMTP server authentication. Related Syntax: <ul style="list-style-type: none"> ● <config># logmail auth <disable/enable>
<i>logmail category</i>	<AAA, ACL, AUTHMGR, CABLE_DIAG, DAI, DHCP_SNOOPING, GVRP, IGMP_SNOOPING, IPSP, L2, LLDP, Mac-based, Mirror, MLD_SNOOPING, Platform, PM, POE, Port, PORT_SECURITY, QoS, Rate, SNMP, STP, Security, System, Surveillance, Trunk, UDLD, VLAN, CLEAR> - Specify one type for the logmail. Related Syntax: <ul style="list-style-type: none"> ● <config># logmail category <AAA, ACL, AUTHMGR, CABLE_DIAG, DAI, DHCP_SNOOPING, GVRP, IGMP_SNOOPING, IPSP, L2, LLDP, Mac-based, Mirror, MLD_SNOOPING, Platform, PM, POE, Port, PORT_SECURITY, QoS, Rate, SNMP, STP, Security, System, Surveillance, Trunk, UDLD, VLAN, CLEAR>
<i>logmail encry</i>	<disable/sslts/starttls> - Specify the encryption type for mail alert. Related Syntax: <ul style="list-style-type: none"> ● <config># logmail encry <disable/ sslts/starttls>
<i>logmail password</i>	<PASSWORD> - Enter the password for SMTP server authentication. Related Syntax: <ul style="list-style-type: none"> ● <config># logmail password <PASSWORD>
<i>logmail port</i>	<0-65535>- Enter a port number. Related Syntax: <ul style="list-style-type: none"> ● <config># logmail port <0-65535>
<i>logmail receiver</i>	Specify an address for receiving the alert mail. <ADDRESS> - Enter the email address of the receiver. Related Syntax: <ul style="list-style-type: none"> ● <config># logmail receiver <ADDRESS>
<i>logmail sender</i>	Specify an address which sends out the alert mail. <ADDRESS> - Enter the email address of the sender. Related Syntax: <ul style="list-style-type: none"> ● <config># logmail
<i>logmail server</i>	Set the IP address of the server.

	<p><ADDRESS> - Enter the IP address of the SMTP server.</p> <p>Related Syntax:</p> <ul style="list-style-type: none"> ● <config># logmail server <ADDRESS>
<i>logmail username</i>	<p><NAME> - Enter the username authenticated by SMTP server.</p> <p>Related Syntax:</p> <ul style="list-style-type: none"> ● <config># logmail username <NAME>

Example

```
P2121# configure
P2121(config)#
P2121(config)# logmail receiver carrie_ni@draytek.com
P2121(config)#
```

Telnet Command: loop-protection

Use this command to set loop-protection.

Syntax Items

loop-protection action
loop-protection periodicTime
loop-protection state

Description

Syntax Items	Description
<i>loop-protection action</i>	Specify an action to be taken when the loop is happened. <all/log/shutdown> - Specify one action to be executed. Related Syntax: <ul style="list-style-type: none">● <config># loop-protection action <all/log/shutdown>
<i>loop-protection periodicTime</i>	Send the loop protection packets to the network hosts. <1-3> - Enter the number of the packet. Related Syntax: <config># Related Syntax: <ul style="list-style-type: none">● <config># loop-protection periodicTime <1-3>
<i>loop-protection state</i>	<enable/disable> - Enable or disable the function of loop protection. Related Syntax: <ul style="list-style-type: none">● <config># loop-protection state <enable/disable>

Example

```
P2121# configure
P2121(config)#
P2121(config)# loop-protection state enable
P2121(config)#
```

Telnet Command: mac

Use this command to create a MAC access list.

Syntax Items

mac acl
mac address-table

Description

Syntax Items	Description
<i>mac acl</i>	<NAME> - Set the name of the access list (ACL). To configure detailed settings, enter the name of ACL to access into next level. <config>#mac acl <NAME> Then, available sub-commands are: <config-mac-acl>#deny <config-mac-acl>#do <config-mac-acl>#end <config-mac-acl>#exit

<config-mac-acl>#permit
<config-mac-acl>#sequence

Use the "deny" command to add deny rules for the MAC access list:

<A:B:C:D:E:F>/<A:B:C:D:E:F>><A:B:C:D:E:F>/<A:B:C:D:E:F> - Specify the source and destination MAC addresses and subnet masks.

cos <0-7><0-7> - Set the cos value and the cos mask for a packet.

<0x0600-0xFFFF> - Set the EtherType of the packet.

Shutdown - Disable the Ethernet interface.

vlan <1-4094> - Specify the VLAN ID of the packet.

any - Any MAC address.

Related Syntax:

- <config-mac-acl >#deny <A:B:C:D:E:F>/<A:B:C:D:E:F> ><A:B:C:D:E:F>/<A:B:C:D:E:F> cos <0-7><0-7>
- <config-mac-acl >#deny <A:B:C:D:E:F>/<A:B:C:D:E:F> ><A:B:C:D:E:F>/<A:B:C:D:E:F> cos <0-7><0-7> ethtype <0x0600-0xFFFF>
- <config-mac-acl >#deny <A:B:C:D:E:F>/<A:B:C:D:E:F> ><A:B:C:D:E:F>/<A:B:C:D:E:F> cos <0-7><0-7> ethtype <0x0600-0xFFFF> shutdown
- <config-mac-acl >#deny <A:B:C:D:E:F>/<A:B:C:D:E:F> ><A:B:C:D:E:F>/<A:B:C:D:E:F> cos <0-7><0-7> shutdown
- <config-mac-acl >#deny <A:B:C:D:E:F>/<A:B:C:D:E:F> ><A:B:C:D:E:F>/<A:B:C:D:E:F> ethtype <0x0600-0xFFFF>
- <config-mac-acl ># deny <A:B:C:D:E:F>/<A:B:C:D:E:F> ><A:B:C:D:E:F>/<A:B:C:D:E:F> ethtype <0x0600-0xFFFF> shutdown
- <config-mac-acl ># deny <A:B:C:D:E:F>/<A:B:C:D:E:F> ><A:B:C:D:E:F>/<A:B:C:D:E:F> shutdown
- <config-mac-acl >#deny any <A:B:C:D:E:F>/<A:B:C:D:E:F> ><A:B:C:D:E:F>/<A:B:C:D:E:F> cos <0-7><0-7>
- <config-mac-acl >#deny any <A:B:C:D:E:F>/<A:B:C:D:E:F> ><A:B:C:D:E:F>/<A:B:C:D:E:F> cos <0-7><0-7> ethtype <0x0600-0xFFFF>
- <config-mac-acl >#deny any <A:B:C:D:E:F>/<A:B:C:D:E:F> ><A:B:C:D:E:F>/<A:B:C:D:E:F> cos <0-7><0-7> ethtype <0x0600-0xFFFF> shutdown
- <config-mac-acl >#deny any <A:B:C:D:E:F>/<A:B:C:D:E:F> ><A:B:C:D:E:F>/<A:B:C:D:E:F> cos <0-7><0-7> shutdown
- <config-mac-acl >#deny any any cos <0-7><0-7>
- <config-mac-acl >#deny any any cos <0-7><0-7> ethtype <0x0600-0xFFFF>
- <config-mac-acl >#deny any any cos <0-7><0-7> ethtype <0x0600-0xFFFF> shutdown
- <config-mac-acl >#deny any any cos <0-7><0-7> shutdown
- <config-mac-acl >#deny any any ethtype <0x0600-0xFFFF>
- <config-mac-acl >#deny any any ethtype <0x0600-0xFFFF> shutdown
- <config-mac-acl >#deny any any shutdown
- <config-mac-acl >#deny any any vlan <1-4094>
- <config-mac-acl >#deny any any vlan <1-4094> cos <0-7><0-7>
- <config-mac-acl >#deny any any vlan <1-4094> cos <0-7><0-7> ethtype <0x0600-0xFFFF>
- <config-mac-acl >#deny any any vlan <1-4094> cos <0-7><0-7> ethtype <0x0600-0xFFFF> shutdown
- <config-mac-acl >#deny any any vlan <1-4094> ethtype <0x0600-0xFFFF>
- <config-mac-acl >#deny any any vlan <1-4094> ethtype <0x0600-0xFFFF> shutdown
- <config-mac-acl >#deny any any vlan <1-4094> shutdown

	<p>Use the “do” command to run execution command in current mode. <SEQUENCE> -</p> <p>Related Syntax:</p> <ul style="list-style-type: none"> ● <config-mac-acl>#do <SEQUENCE>
	<p>Use the “end” command to finish current mode. Any changes in current mode will be saved.</p> <p>Related Syntax:</p> <ul style="list-style-type: none"> ● <config-mac-acl>#end
	<p>Use the “exit” command to close the current CLI session or return to the previous mode without saving the settings.</p> <p>Related Syntax:</p> <ul style="list-style-type: none"> ● <config-mac-acl>#exit
	<p>Use the “no sequence” command to delete any entry in management ACL.</p> <p><1-65535>- Specify an index number of the ACL.</p> <p>Related Syntax:</p> <ul style="list-style-type: none"> ● <config-mac-acl>#no sequence <1-65535>
	<p>Use the “permit” command to add permit rules which bypass the packets meet the rule.</p> <p><A:B:C:D:E:F>/<A:B:C:D:E:F >- Specify the source and destination MAC addresses and subnet masks.</p> <p>cos <0-7><0-7> - Set the cos value and the cos mask for a packet.</p> <p><0x0600-0xFFFF> - Set the EtherType of the packet.</p> <p>Shutdown - Disable the Ethernet interface.</p> <p>vlan <1-4094> - Specify the VLAN ID of the packet.</p> <p>any - Any MAC address.</p> <p>Related Syntax:</p> <ul style="list-style-type: none"> ● <config-mac-acl >#permit <A:B:C:D:E:F>/<A:B:C:D:E:F> cos <0-7><0-7> ● <config-mac-acl >#permit <A:B:C:D:E:F>/<A:B:C:D:E:F> cos <0-7><0-7> ethtype <0x0600-0xFFFF> ● <config-mac-acl >#permit <A:B:C:D:E:F>/<A:B:C:D:E:F> ethtype <0x0600-0xFFFF> ● <config-mac-acl >#permit <A:B:C:D:E:F>/<A:B:C:D:E:F> vlan <1-4094> ● <config-mac-acl >#permit <A:B:C:D:E:F>/<A:B:C:D:E:F> vlan <1-4094>cos <0-7><0-7> ● <config-mac-acl >#permit <A:B:C:D:E:F>/<A:B:C:D:E:F> vlan <1-4094>cos <0-7><0-7> ethtype <0x0600-0xFFFF> ● <config-mac-acl >#permit <A:B:C:D:E:F>/<A:B:C:D:E:F> vlan <1-4094>ethtype <0x0600-0xFFFF> ● <config-mac-acl >#permit any <A:B:C:D:E:F>/<A:B:C:D:E:F> cos <0-7><0-7> ● <config-mac-acl >#permit any <A:B:C:D:E:F>/<A:B:C:D:E:F> cos <0-7><0-7>ethtype <0x0600-0xFFFF> ● <config-mac-acl >#permit any <A:B:C:D:E:F>/<A:B:C:D:E:F> ethtype <0x0600-0xFFFF> ● <config-mac-acl >#permit any <A:B:C:D:E:F>/<A:B:C:D:E:F> vlan <1-4094> ● <config-mac-acl >#permit any <A:B:C:D:E:F>/<A:B:C:D:E:F> vlan <1-4094> cos <0-7><0-7> ● <config-mac-acl >#permit any <A:B:C:D:E:F>/<A:B:C:D:E:F> vlan <1-4094> cos <0-7><0-7>ethtype <0x0600-0xFFFF> ● <config-mac-acl >#permit any <A:B:C:D:E:F>/<A:B:C:D:E:F> vlan <1-4094> ethtype <0x0600-0xFFFF>
	<p>Use the “sequence” command to deny or permit the ACL.</p>

<1-2147483647> - Enter the sequence index ACE. The sequence represents the priority of the ACE in the ACL.
 <A:B:C:D:E:F>/<A:B:C:D:E:F >- Specify the source and destination MAC addresses and subnet masks.
 cos <0-7><0-7> - Set the cos value and the cos mask for a packet.
 <0x0600-0xFFFF> - Set the EtherType of the packet.
 shutdown - Disable the Ethernet interface.
 vlan <1-4094> - Specify the VLAN ID of the packet.
 any - Any MAC address.

Related Syntax:

- <config-mac-acl >#sequence <1-2147483647>deny <A:B:C:D:E:F>/<A:B:C:D:E:F ><A:B:C:D:E:F>/<A:B:C:D:E:F> cos <0-7><0-7>
- <config-mac-acl >#sequence <1-2147483647>deny <A:B:C:D:E:F>/<A:B:C:D:E:F ><A:B:C:D:E:F>/<A:B:C:D:E:F> cos <0-7><0-7> ethtype <0x0600-0xFFFF>
- <config-mac-acl >#sequence <1-2147483647>deny <A:B:C:D:E:F>/<A:B:C:D:E:F ><A:B:C:D:E:F>/<A:B:C:D:E:F> cos <0-7><0-7> ethtype <0x0600-0xFFFF> shutdown
- <config-mac-acl >#sequence <1-2147483647>deny <A:B:C:D:E:F>/<A:B:C:D:E:F ><A:B:C:D:E:F>/<A:B:C:D:E:F> cos <0-7><0-7> shutdown
- <config-mac-acl >#sequence <1-2147483647>deny <A:B:C:D:E:F>/<A:B:C:D:E:F ><A:B:C:D:E:F>/<A:B:C:D:E:F> ethtype <0x0600-0xFFFF>
- <config-mac-acl >#sequence <1-2147483647>deny <A:B:C:D:E:F>/<A:B:C:D:E:F ><A:B:C:D:E:F>/<A:B:C:D:E:F> ethtype <0x0600-0xFFFF> shutdown
- <config-mac-acl >#sequence <1-2147483647>deny <A:B:C:D:E:F>/<A:B:C:D:E:F ><A:B:C:D:E:F>/<A:B:C:D:E:F> shutdown
- <config-mac-acl >#sequence <1-2147483647>deny any <A:B:C:D:E:F>/<A:B:C:D:E:F ><A:B:C:D:E:F>/<A:B:C:D:E:F> cos <0-7><0-7>
- <config-mac-acl >#sequence <1-2147483647>deny any <A:B:C:D:E:F>/<A:B:C:D:E:F ><A:B:C:D:E:F>/<A:B:C:D:E:F> cos <0-7><0-7> ethtype <0x0600-0xFFFF>
- <config-mac-acl >#sequence <1-2147483647>deny any <A:B:C:D:E:F>/<A:B:C:D:E:F ><A:B:C:D:E:F>/<A:B:C:D:E:F> cos <0-7><0-7> ethtype <0x0600-0xFFFF> shutdown
- <config-mac-acl >#sequence <1-2147483647>deny any <A:B:C:D:E:F>/<A:B:C:D:E:F ><A:B:C:D:E:F>/<A:B:C:D:E:F> cos <0-7><0-7> shutdown
- <config-mac-acl >#sequence <1-2147483647>deny any any cos <0-7><0-7>
- <config-mac-acl >#sequence <1-2147483647>deny any any cos <0-7><0-7> ethtype <0x0600-0xFFFF>
- <config-mac-acl >#sequence <1-2147483647>deny any any cos <0-7><0-7> ethtype <0x0600-0xFFFF> shutdown
- <config-mac-acl >#sequence <1-2147483647>deny any any cos <0-7><0-7> shutdown
- <config-mac-acl >#sequence <1-2147483647>deny any any ethtype <0x0600-0xFFFF>
- <config-mac-acl >#sequence <1-2147483647>deny any any ethtype <0x0600-0xFFFF> shutdown
- <config-mac-acl >#sequence <1-2147483647>deny any any shutdown
- <config-mac-acl >#sequence <1-2147483647>deny any any vlan <1-4094>
- <config-mac-acl >#sequence <1-2147483647>deny any any vlan <1-4094> cos <0-7><0-7>
- <config-mac-acl >#sequence <1-2147483647>deny any any

	<pre> vlan <1-4094> cos <0-7><0-7> ethtype <0x0600-0xFFFF> ● <config-mac-acl >#sequence <1-2147483647>deny any any vlan <1-4094> cos <0-7><0-7> ethtype <0x0600-0xFFFF> shutdown ● <config-mac-acl >#sequence <1-2147483647>deny any any vlan <1-4094> ethtype <0x0600-0xFFFF> ● <config-mac-acl >#sequence <1-2147483647>deny any any vlan <1-4094> ethtype <0x0600-0xFFFF> shutdown ● <config-mac-acl >#sequence <1-2147483647>deny any any vlan <1-4094> shutdown ● <config-mac-acl >#sequence <1-2147483647>permit <A:B:C:D:E:F>/<A:B:C:D:E:F> <A:B:C:D:E:F>/<A:B:C:D:E:F> cos <0-7><0-7> ● <config-mac-acl >#sequence <1-2147483647>permit <A:B:C:D:E:F>/<A:B:C:D:E:F> <A:B:C:D:E:F>/<A:B:C:D:E:F> cos <0-7><0-7> ethtype <0x0600-0xFFFF> ● <config-mac-acl >#sequence <1-2147483647>permit <A:B:C:D:E:F>/<A:B:C:D:E:F> <A:B:C:D:E:F>/<A:B:C:D:E:F> ethtype <0x0600-0xFFFF> ● <config-mac-acl >#sequence <1-2147483647>permit <A:B:C:D:E:F>/<A:B:C:D:E:F> <A:B:C:D:E:F>/<A:B:C:D:E:F> vlan <1-4094> ● <config-mac-acl >#sequence <1-2147483647>permit <A:B:C:D:E:F>/<A:B:C:D:E:F> <A:B:C:D:E:F>/<A:B:C:D:E:F> vlan <1-4094> cos <0-7><0-7> ● <config-mac-acl >#sequence <1-2147483647>permit <A:B:C:D:E:F>/<A:B:C:D:E:F> <A:B:C:D:E:F>/<A:B:C:D:E:F> vlan <1-4094> cos <0-7><0-7> ethtype <0x0600-0xFFFF> ● <config-mac-acl >#sequence <1-2147483647>permit <A:B:C:D:E:F>/<A:B:C:D:E:F> <A:B:C:D:E:F>/<A:B:C:D:E:F> vlan <1-4094> ethtype <0x0600-0xFFFF> ● <config-mac-acl >#sequence <1-2147483647>permit any <A:B:C:D:E:F>/<A:B:C:D:E:F> cos <0-7><0-7> ● <config-mac-acl >#sequence <1-2147483647>permit any <A:B:C:D:E:F>/<A:B:C:D:E:F> cos <0-7><0-7> ethtype <0x0600-0xFFFF> ● <config-mac-acl >#sequence <1-2147483647>permit any <A:B:C:D:E:F>/<A:B:C:D:E:F> vlan <1-4094> ● <config-mac-acl >#sequence <1-2147483647>permit any <A:B:C:D:E:F>/<A:B:C:D:E:F> vlan <1-4094> cos <0-7><0-7> ● <config-mac-acl >#sequence <1-2147483647>permit any <A:B:C:D:E:F>/<A:B:C:D:E:F> vlan <1-4094> cos <0-7><0-7> ethtype <0x0600-0xFFFF> ● <config-mac-acl >#sequence <1-2147483647>permit any <A:B:C:D:E:F>/<A:B:C:D:E:F> vlan <1-4094> ethtype <0x0600-0xFFFF> ● <config-mac-acl >#sequence <1-2147483647>permit any any cos <0-7><0-7> ● <config-mac-acl >#sequence <1-2147483647>permit any any cos <0-7><0-7> ethtype <0x0600-0xFFFF> ● <config-mac-acl >#sequence <1-2147483647>permit any any ethtype <0x0600-0xFFFF> ● <config-mac-acl >#sequence <1-2147483647>permit any any vlan <1-4094> ● <config-mac-acl >#sequence <1-2147483647>permit any any vlan <1-4094> cos <0-7><0-7> ● <config-mac-acl >#sequence <1-2147483647>permit any any vlan <1-4094> cos <0-7><0-7> ethtype <0x0600-0xFFFF> ● <config-mac-acl >#sequence <1-2147483647>permit any any vlan <1-4094> ethtype <0x0600-0xFFFF> </pre>
<i>mac address-table</i>	<pre> Set the aging time for an entry remains in the MAC address table. address-table static - Add a static address to the MAC address table to drop the packets with the specified source or destination MAC </pre>

	<p>address.</p> <p><10-630> - Unit is second. Default is 300.</p> <p>static <A:B:C:D:E:F> - Enter the MAC address.</p> <p>vlan <1-4094> - Specify the VLAN ID of the packet.</p> <p>gigabitEthernet <1-12> - Specify a physical port.</p> <p>LAG <1-8> - Specify a LAG port.</p> <p>Related Syntax:</p> <ul style="list-style-type: none"> ● <config># mac address-table aging-time <10-630> ● <config># mac address-table static <A:B:C:D:E:F> vlan <1-4094> drop ● <config># mac address-table static <A:B:C:D:E:F> vlan <1-4094> interfaces GigabitEthernet <1-12> ● <config># mac address-table static <A:B:C:D:E:F> vlan <1-4094> interfaces LAG <1-8>
--	--

Example

```
P2121# configure
P2121(config)# mac acl test_CA
P2121(config-mac-acl)# deny 00:50:00:7f:12:11/00:00:00:00:10:20
00:50:00:aa:bb:cc/00:00:00:00:12:00 cos 3 2 ethtype 0x0600
P2121(config-mac-acl)# deny any 00:50:00:7f:12:11/00:00:00:00:10:20 cos 5 6
ethtype 0x0600
P2121(config-mac-acl)# deny any
P2121(config)# mac address-table static 00:50:07:12:ff:aa vlan 300 drop
```

Telnet Command: mail alert

Use this command to configure mail alert for various conditions.

Syntax Items

mailalert active
 mailalert auth
 mailalert devicecheck
 mailalert encry
 mailalert hwmon
 mailalert interval
 mailalert ipconfilict
 mailalert password
 mailalert poestatus
 mailalert port
 mailalert portlink
 mailalert portspeed
 mailalert receiver
 mailalert sender
 mailalert server
 mailalert sysrestart
 mailalert throughputcheck
 mailalert username

Description

Syntax Items	Description
<i>mailalert active</i>	<disable/enable> - Enable or disable the function of mail alert. Related Syntax: <ul style="list-style-type: none"> ● <config># mailalert active <disable/enable>
<i>mailalert auth</i>	<disable/enable> - Enable or disable the function of SMTP server

	<p>authentication.</p> <p>Related Syntax:</p> <ul style="list-style-type: none"> ● <config># mailalert auth <disable/enable>
<i>mailalert devicecheck</i>	<p><disable/enable> - Enable or disable the function of sending a mail alert when encountering a device check error.</p> <p>Related Syntax:</p> <ul style="list-style-type: none"> ● <config># mailalert devicecheck <disable/enable>
<i>mailalert encry</i>	<p><disable/sslTls/startTls> - Specify the encryption type for mail alert.</p> <p>Related Syntax:</p> <ul style="list-style-type: none"> ● <config># mailalert encry <disable/ sslTls/startTls>
<i>mailalert hwmon</i>	<p>Send a mail alert when hardware monitor error.</p> <p><disable/enable> - Enable or disable the function.</p> <p>Related Syntax:</p> <ul style="list-style-type: none"> ● <config># mailalert hwmon <disable/enable>
<i>mailalert interval</i>	<p>Set the transmission interval for the mail alert.</p> <p><1-60> - Unit is second.</p> <p>Related Syntax:</p> <ul style="list-style-type: none"> ● <config># mailalert interval <1-60>
<i>mailalert ipconflict</i>	<p><disable/enable> - Enable or disable the function of sending a mail alert if encountering the IP conflict.</p> <p>Related Syntax:</p> <ul style="list-style-type: none"> ● <config># mailalert ipconflict <disable/enable>
<i>mailalert password</i>	<p><PASSWORD> - Enter the password for SMTP server authentication.</p> <p>Related Syntax:</p> <ul style="list-style-type: none"> ● <config># mailalert password <PASSWORD>
<i>mailalert poestatus</i>	<p><disable/enable> - Enable or disable the function of sending a mail alert when PoE status is changed.</p> <p>Related Syntax:</p> <ul style="list-style-type: none"> ● <config># mailalert poestatus <disable/enable>
<i>mailalert port</i>	<p><0-65535>- Enter a port number.</p> <p>Related Syntax:</p> <p><config># mailalert port <0-65535></p>
<i>mailalert portlink</i>	<p><disable/enable> - Enable or disable the function of sending an alert when the port link status changes.</p> <p>Related Syntax:</p> <ul style="list-style-type: none"> ● <config># mailalert portlink <disable/enable>
<i>mailalert portspeed</i>	<p><disable/enable> - Enable or disable the function of sending an alert when the port link speed changes.</p> <p>Related Syntax:</p> <ul style="list-style-type: none"> ● <config># mailalert portspeed <disable/enable>
<i>mailalert receiver</i>	<p>Specify an address for receiving the alert mail.</p> <p><ADDRESS> - Enter the email address of the receiver.</p> <p>Related Syntax:</p> <ul style="list-style-type: none"> ● <config># mailalert receiver <ADDRESS>
<i>mailalert sender</i>	<p>Specify an address which sends out the alert mail.</p> <p><ADDRESS> - Enter the email address of the sender.</p> <p>Related Syntax:</p> <ul style="list-style-type: none"> ● <config># mailalert sender <ADDRESS>
<i>mailalert server</i>	<p>Set the IP address of the server.</p> <p><ADDRESS> - Enter the IP address of the SMTP server.</p>

	Related Syntax: <ul style="list-style-type: none"> ● <config># mailalert server <ADDRESS>
<i>mailalert sysrestart</i>	<disable/enable> -Enable or disable the function of sending a mail alert when the system restarts. Related Syntax: <ul style="list-style-type: none"> ● <config># mailalert sysrestart <disable/enable>
<i>mailalert throughputcheck</i>	<disable/enable> - Enable or disable the function of sending a mail alert when reaching the throughput threshold. Related Syntax: <ul style="list-style-type: none"> ● <config># mailalert throughputcheck <disable/enable>
<i>mailalert username</i>	<NAME> - Enter the username authenticated by STMP server. Related Syntax: <ul style="list-style-type: none"> ● <config># mailalert username <NAME>

Example

```
P2121# configure
P2121(config)#
P2121(config)# mailalert receiver carrie_ni@draytek.com
```

Telnet Command: management

Use this command to create a management access list and set configuration mode.

Syntax Items

management access-list
management access-class

Description

Syntax Items	Description
<i>management access-list</i>	<NAME> - Enter the name of the access list. To configure detailed settings, enter the name of ACL to access into next level. <config>#management access-list <NAME> Then, available sub-commands are: <config-macl>#deny <config-macl>#do <config-macl>#end <config-macl>#exit <config-macl>#permit <config-macl>#sequence
	Use the "deny" command to add deny rules for the management access list: GigabitEthernet <1-12> - Specify a physical port. LAG <1-8> - Specify a LAG port. service <all/http/https/snmp/ssh/telnet> - Specify the servcie type. ip <A.B.C.D>/<A.B.C.D> - Specify the source IP address with mask for the packets. ipv6 <X:X::X:X>/<0-128> - Specify the source IPv6 address and prefix length of the packet. Related Syntax: <ul style="list-style-type: none"> ● <config-macl>#deny interfaces GigabitEthernet <1-12>

<p>service <all/http/https/snmp/ssh/telnet></p> <ul style="list-style-type: none"> ● <config-macl>#deny interfaces LAG <1-8> service <all/http/https/snmp/ssh/telnet> ● <config-macl>#deny ip <A.B.C.D>/<A.B.C.D> interfaces GigabitEthernet <1-12> service <all/http/https/snmp/ssh/telnet> ● <config-macl>#deny ip <A.B.C.D>/<A.B.C.D> interfaces LAG <1-8> service <all/http/https/snmp/ssh/telnet> ● <config-macl>#deny ipv6 <X::X:X>/<0-128> interfaces GigabitEthernet <1-12> service <all/http/https/snmp/ssh/telnet> ● <config-macl>#deny ipv6 <X::X:X>/<0-128> interfaces LAG <1-8> service <all/http/https/snmp/ssh/telnet>
<p>Use the “do” command to run execution command in current mode. <SEQUENCE> -</p> <p>Related Syntax:</p> <ul style="list-style-type: none"> ● <config-macl>#do <SEQUENCE>
<p>Use the “end” command to finish current mode. Any changes in current mode will be saved.</p> <p>Related Syntax:</p> <ul style="list-style-type: none"> ● <config-macl>#end
<p>Use the “exit” command to close the current CLI session or return to the previous mode without saving the settings.</p> <p>Related Syntax:</p> <ul style="list-style-type: none"> ● <config-macl>#exit
<p>Use the “no sequence” command to delete any entry in management ACL.</p> <p><1-65535>- Specify an index number of the ACL.</p> <p>Related Syntax:</p> <ul style="list-style-type: none"> ● <config-macl>#no sequence <1-65535>
<p>Use the “permit” command to add permit rules which bypass the packets meet the rule.</p> <p>GigabitEthernet <1-12> - Specify a physical port. LAG <1-8> - Specify a LAG port. service <all/http/https/snmp/ssh/telnet> - Specify the service type. ip <A.B.C.D>/<A.B.C.D> - Specify the source IP address with mask for the packets. ipv6 <X::X:X>/<0-128> - Specify the source IPv6 address and prefix length of the packet.</p> <p>Related Syntax:</p> <ul style="list-style-type: none"> ● <config-macl>#permit interfaces GigabitEthernet <1-12> service <all/http/https/snmp/ssh/telnet> ● <config-macl>#permit interfaces LAG <1-8> service <all/http/https/snmp/ssh/telnet> ● <config-macl>#permit ip <A.B.C.D>/<A.B.C.D> interfaces GigabitEthernet <1-12> service <all/http/https/snmp/ssh/telnet> ● <config-macl>#permit ip <A.B.C.D>/<A.B.C.D> interfaces LAG <1-8> service <all/http/https/snmp/ssh/telnet> ● <config-macl>#permit ipv6 <X::X:X>/<0-128> interfaces GigabitEthernet <1-12> service <all/http/https/snmp/ssh/telnet> ● <config-macl>#permit ipv6 <X::X:X>/<0-128> interfaces LAG <1-8> service <all/http/https/snmp/ssh/telnet>

	<p>Use the “sequence” command to deny or permit the ACL. <1-65535>- Specify an index number of the ACL. GigabitEthernet <1-12> - Specify a physical port. LAG <1-8> - Specify a LAG port. service <all/http/https/snmp/ssh/telnet> - Specify the service type. ip <A.B.C.D>/<A.B.C.D> - Specify the source IP address with mask for the packets. ipv6 <X:X::X:X>/<0-128> - Specify the source IPv6 address and prefix length of the packet.</p> <p>Related Syntax:</p> <ul style="list-style-type: none"> ● <config-macl>#sequence <1-65535>deny interfaces GigabitEthernet <1-12> service <all/http/https/snmp/ssh/telnet> ● <config-macl>#sequence <1-65535>deny interfaces LAG <1-8> service <all/http/https/snmp/ssh/telnet> ● <config-macl>#sequence <1-65535>deny ip <A.B.C.D>/<A.B.C.D> interfaces GigabitEthernet <1-12> service <all/http/https/snmp/ssh/telnet> ● <config-macl>#sequence <1-65535>deny ip <A.B.C.D>/<A.B.C.D> interfaces LAG <1-8> service <all/http/https/snmp/ssh/telnet> ● <config-macl>#sequence <1-65535>deny ipv6 <X:X::X:X>/<0-128> interfaces GigabitEthernet <1-12> service <all/http/https/snmp/ssh/telnet> ● <config-macl>#sequence <1-65535>deny ipv6 <X:X::X:X>/<0-128> interfaces LAG <1-8> service <all/http/https/snmp/ssh/telnet> ● <config-macl>#sequence <1-65535> permit interfaces GigabitEthernet <1-12> service <all/http/https/snmp/ssh/telnet> ● <config-macl>#sequence <1-65535> permit interfaces LAG <1-8> service <all/http/https/snmp/ssh/telnet> ● <config-macl>#sequence <1-65535> permit ip <A.B.C.D>/<A.B.C.D> interfaces GigabitEthernet <1-12> service <all/http/https/snmp/ssh/telnet> ● <config-macl>#sequence <1-65535> permit ip <A.B.C.D>/<A.B.C.D> interfaces LAG <1-8> service <all/http/https/snmp/ssh/telnet> ● <config-macl>#sequence <1-65535> permit ipv6 <X:X::X:X>/<0-128> interfaces GigabitEthernet <1-12> service <all/http/https/snmp/ssh/telnet> ● <config-macl>#sequence <1-65535> permit <X:X::X:X>/<0-128> interfaces LAG <1-8> service <all/http/https/snmp/ssh/telnet>
<i>management access-class</i>	<p>Specify an ACL as active access-list. <NAME> - Enter the name of the access list.</p> <p>Related Syntax:</p> <ul style="list-style-type: none"> ● <config># management access-class <NAME>

Example

```
P2121# configure
P2121(config)#
P2121(config)# management access-list CA_ACL
P2121(config-macl)# deny ip 192.168.2.56/255.255.255.0 interfaces
gigabitethernet 3 service telnet
P2121(config-macl)#
```

```
P2121(config-macl)# deny ipv6 00:50::7f:3b/24
```

Telnet Command: management-vlan

Use this command to set VLAN ID for management VLAN.

Syntax Items

management-vlan vlan

Description

Syntax Items	Description
<i>management-vlan vlan</i>	Set the management VLAN ID. <1-4094>- Specify the VLAN ID number of management VLAN. Related Syntax: <ul style="list-style-type: none">● <config># management-vlan vlan <1-4094>

Example

```
P2121# configure
P2121(config)#
P2121(config)# management-vlan vlan 200
VLAN 200: VLAN does not exist
P2121(config)#
```

Telnet Command: mirror

Use this command to set the source / destination interface of a port mirror session.

Syntax Items

mirror session

Description

Syntax Items	Description
<i>mirror session</i>	Set the destination interface of a port mirror session. <1-4> - Specify the mirror session ID number. GigabitEthernet <1-12> - Specify a physical port. allow-ingress - Enable the ingress traffic forwarding. <both/rx/tx> - Specify the mirror direction, TX only, RX only or TX and RX. Related Syntax: <ul style="list-style-type: none">● <config># mirror session <1-4> destination interface GigabitEthernet <1-12> allow-ingress● <config># mirror session <1-4> source interfaces GigabitEthernet <1-12> <both/rx/tx>

Example

```
P2121# configure
P2121(config)#
P2121(config)# mirror session 3 destination interface GigabitEthernet 3 allow
P2121(config)#
P2121(config)# mirror session 3 source interfaces LAG 3 both
```

```
P2121(config)#
```

Telnet Command: mvr

Use this command to enable MVR function and configure related settings.

Syntax Items

```
mvr
mvr group
mvr mode
mvr query-time
mvr vlan
```

Description

Syntax Items	Description
<i>mvr</i>	Enable MVR function. Related Syntax: <ul style="list-style-type: none">● <config># mvr
<i>mvr group</i>	Set MVR group address. <A.B.C.D> - Enter an IP address. <1-128> - Specify a number for contiguous series of IPv4 multicast address. Related Syntax: <ul style="list-style-type: none">● <config># mvr group <A.B.C.D><1-128>
<i>mvr mode</i>	Set MVR mode as compatible or dynamic. <compatible> - The switch does not support IGMP dynamic joins on the source ports. <dynamic> - The switch supports MVR membership on the source ports. Related Syntax: <ul style="list-style-type: none">● <config># mvr mode <compatible/dynamic>
<i>mvr query-time</i>	Set query response time for MVR. <1-10> - Specify the response time (second). Related Syntax: <ul style="list-style-type: none">● <config># mvr query-time <1-10>
<i>mvr vlan</i>	Set a VLAN ID for MVR. <1-4094> - Specify the existed static VLAN ID. Related Syntax: <ul style="list-style-type: none">● <config># mvr vlan <1-4094>

Example

```
P2121# configure
P2121(config)#
P2121(config)# mvr group 192.168.2.33
The operation will delete the MVR VLAN groups include static MVR groups.Continue
? [yes/no]:y
Input Parameter Error
P2121(config)#
```

Telnet Command: no

Use this command to disable specific command.

Syntax Items

no <command>

Example

```
P2121# configure
P2121(config)#
P2121(config)# no port-security
P2121(config)#
```

Telnet Command: openvpn

Use this command to enable/disable the OpenVPN tunnel.

Syntax Items

openvpn enable
openvpn disable
openvpn filename

Description

Syntax Items	Description
<i>enable</i>	Enable the OpenVPN tunnel.
<i>disable</i>	Disable the OpenVPN tunnel.
<i>filename</i>	<NAME> - Define a name for OpenVPN configuration. Related Syntax: <ul style="list-style-type: none">● <config># openvpn filename <NAME>

Example

```
P2121# configure
P2121(config)#
P2121(config)#
```

Telnet Command: poe

Use this command configure settings for PoE device.

Syntax Items

poe mode
poe schedule

Description

Syntax Items	Description
<i>poe mode</i>	auto - VigorSwitch determines the power watts for PoE device based on actual demand. manual - VigorSwitch will supply actual power demand for the PoE device and reserved PD class power for the PoE device. none - VigorSwitch does not supply any power for the PoE device. Related Syntax: <ul style="list-style-type: none">● <config># poe mode auto

	<ul style="list-style-type: none"> ● <config># poe mode manual ● <config># poe mode none
<i>poe schedule</i>	<p>Specify a schedule for PoE device.</p> <p>global-enable -</p> <p>index <1-24> - Specify the index number of the schedule profiles.</p> <p>Related Syntax:</p> <ul style="list-style-type: none"> ● <config># poe schedule global-enable ● <config># poe schedule index <1-24>

Example

```
P2121# configure
P2121(config)#
P2121(config)# poe
```

Telnet Command: port-security

Use this command to enable the function of port security.

Syntax Items

port-security

Example

```
P2121# configure
P2121(config)#
P2121(config)# port-security
P2121(config)#
```

Telnet Command: qos

Use this command to configure QoS settings.

Syntax Items

qos
qos map
qos queue
qos trust

Description

Syntax Items	Description
<i>qos</i>	Enable the quality of service based on basic trust type to assign the queue for packets. Related Syntax: <ul style="list-style-type: none">● <config># qos
<i>qos map</i>	map cos-queue - Set the CoS to queue map. map dscp-queue - Set the DSCP to queue map. map precedence-queue - Set the IP Precedence to queue map. map queue-cos - Modify the queue to CoS map. map queue-dscp - Modify the queue to DSCP map. map queue-precedence - Modify the queue to IP precedence map. <1-8> - Specify the queue number for the following CoS values mapped. <1-8> - Specify the queue number to which the DSCP value shall correspond. <1-8> - Specify the queue number to which the IP precedence value shall correspond. <0-7> - Enter the cos value to which the queue ID shall correspond. <0-7> - Enter the DSCP value to which the queue ID shall correspond. <0-7> - Enter the IP precedence value to which the queue ID shall correspond. Related Syntax: <ul style="list-style-type: none">● <config># qos map cos-queue SEQUENCE to <1-8>● <config># qos map dscp-queue SEQUENCE to <1-8>● <config># qos map precedence-queue SEQUENCE to <1-8>● <config># qos map queue-cos SEQUENCE to <0-7>● <config># qos map queue-dscp SEQUENCE to <0-7>● <config># qos map queue-precedence SEQUENCE to <0-7>
<i>qos queue</i>	queue strict-priority-num - Set the number of strict priority queue. queue weight SEQUENCE - Set the number of non-strict priority queue. <0-8> - Specify the queue number. <weight1-weight8> <1-127> - Specify a number (1~127) representing queue weight value. Related Syntax: <ul style="list-style-type: none">● <config># qos queue strict-priority-num <0-8>● <config># qos queue weight SEQUENCE <weight1 - weight8> <1-127>
<i>qos trust</i>	Set the trust type, cos, for the device to judge the appropriate queue of the packets. Related Syntax:

- <config># qos trust <cos/cos-dscp/ dscp/ip-precedence>

Example

```
P2121# configure
P2121(config)#
P2121(config)# qos map cos-queue SEQUENCE to 3
P2121(config)#
```

Telnet Command: radius

Use this command to configure settings for RADIUS server.

Syntax Items

radius default-config

radius host

Description

Syntax Items	Description
<i>radius default-config</i>	<p>Key <RADIUSKEY> - Specify key string for RADIUS server.</p> <p>Retransmit <1-10> - Specify the retransmit times (from 1 to 10) for RADIUS server.</p> <p>Timeout <1-30> - Specify the time out value (from 1 to 30) for RADIUS server.</p> <p>Related Syntax:</p> <ul style="list-style-type: none"> ● <config># radius default-config key <RADIUSKEY> ● <config># radius default-config key <RADIUSKEY> retransmit <1-10> ● <config># radius default-config key <RADIUSKEY> retransmit <1-10> timeout <1-30> ● <config># radius default-config retransmit <1-10> ● <config># radius default-config retransmit <1-10> timeout <1-30> ● <config># radius default-config timeout <1-30>
<i>radius host</i>	<p>host <HOSTNAME> - Specify a domain name or IP address for RADIUS server host.</p> <p>auth-port <0-65535> - Speicfy a UDP port number for RADIUS server.</p> <p>key <RADIUSKEY> - Specify key string for RADIUS server.</p> <p>priority <0-65535> - Specify the priority for RADIUS server.</p> <p>retransmit <1-10> - Specify the retransmit times (from 1 to 10) for RADIUS server.</p> <p>timeout <1-30> - Specify the time out value (from 1 to 30) for RADIUS server.</p> <p>type <802.1x / all / login> - Choose the usage type for 802.1X authentication, or login, or both 802.1X authentication and login of RADIUS type.</p> <p>Related Syntax:</p> <ul style="list-style-type: none"> ● <config># radius host <HOSTNAME> auth-port <0-65535> ● <config># radius host <HOSTNAME> auth-port <0-65535> key <RADIUSKEY> ● <config># radius host <HOSTNAME> auth-port <0-65535> key <RADIUSKEY> priority <0-65535> ● <config># radius host <HOSTNAME> auth-port <0-65535> key <RADIUSKEY> priority <0-65535> retransmit <1-10> ● <config># radius host <HOSTNAME> auth-port <0-65535> key <RADIUSKEY> priority <0-65535> retransmit <1-10> timeout <1-30> type <802.1x / all / login>

- <config># radius host <HOSTNAME> key <RADIUSKEY>
- <config># radius host <HOSTNAME> key <RADIUSKEY> priority <0-65535>
- <config># radius host <HOSTNAME> key <RADIUSKEY> priority <0-65535> retransmit <1-10>
- <config># radius host <HOSTNAME> key <RADIUSKEY> priority <0-65535> retransmit <1-10> timeout <1-30>
- <config># radius host <HOSTNAME> key <RADIUSKEY> priority <0-65535> retransmit <1-10> timeout <1-30> type <802.1x / all / login>
- <config># radius host <HOSTNAME> priority <0-65535>
- <config># radius host <HOSTNAME> priority <0-65535> retransmit <1-10>
- <config># radius host <HOSTNAME> priority <0-65535> retransmit <1-10> timeout <1-30>
- <config># radius host <HOSTNAME> priority <0-65535> retransmit <1-10> timeout <1-30> type <802.1x / all / login>
- <config># radius host <HOSTNAME> retransmit <1-10>
- <config># radius host <HOSTNAME> retransmit <1-10> timeout <1-30>
- <config># radius host <HOSTNAME> retransmit <1-10> timeout <1-30> type <802.1x / all / login>
- <config># radius host <HOSTNAME> timeout <1-30>
- <config># radius host <HOSTNAME> timeout <1-30> type <802.1x / all / login>
- <config># radius host <HOSTNAME> type <802.1x / all / login>

Example

```
P2121# configure
P2121(config)#
P2121(config)# radius default-config key 123456789 retransmit 3 timeout 10
P2121(config)# radius host radius auth-port 3000
```

Telnet Command: schedule

Use this command to set schedule.

Syntax Items

schedule index

Description

Syntax Items	Description
<i>schedule index</i>	<p>Specify an index number for configuring detailed settings of a schedule profile.</p> <p><1-15> - Enter a number to select a schedule profile.</p> <p><DESCRIPTION> - Give a brief description for such profile.</p> <p>cycle-days - The action applied with the schedule will take place every few days.</p> <p>monthly-date - The action applied with the schedule will take place in specified day within a month.</p> <p>once - The action applied with the schedule will take place for one time.</p> <p>weekdays - The action applied with the schedule will take place on a certain day within a week.</p> <p><1-31> - Enter a number to make action repeat.</p> <p><apr / aug / dec / feb /jan / jul / jun /jul / mar / may / nov / oct / sep > - Represent month of April, August, December, February, January, July, June, March, May, November, October, and</p>

	<p>September.</p> <p><sun / mon / tue / wed / thu / fri / sat> - Represent Sunday, Monday, Tuesday, Wednesday, Thursday, Friday and Saturday.</p> <p><1-31> - Enter a number as the start date within a month.</p> <p><2000-2035> - Enter the number as the year of start date.</p> <p><HH:MM> - Enter the hours and the minutes.</p> <p><on/off> - Enable (on) or disable (off) the action applied with such profile.</p> <p>Related Syntax:</p> <ul style="list-style-type: none"> ● <config># schedule index <1-15> description <DESCRIPTION> ● <config># schedule index <1-15> how-often cycle-days <1-31> start-date <apr / aug / dec / feb / jan / jul / jun / mar / may / nov / oct / sep > <1-31> <2000-2035> start-time <HH:MM> duration <HH:MM> action <on/off> ● <config># schedule index <1-15> how-often monthly-date <1-31> start-date <apr / aug / dec / feb /jan / jul / jun / mar / may / nov / oct / sep > <1-31> <2000-2035> start-time <HH:MM> duration <HH:MM> action <on/off> ● <config># schedule index <1-15> how-often once start-date<apr / aug / dec / feb /jan / jul / jun / mar / may / nov / oct / sep > <1-31> <2000-2035> start-time <HH:MM> duration <HH:MM> action <on/off> ● <config># schedule index <1-15> how-often weekdays <sun /mon /tue /wed / thu / fri / sat> start-date <apr / aug / dec / feb /jan / jul / jun / mar / may / nov / oct / sep > <1-31> <2000-2035> start-time <HH:MM> duration <HH:MM> action <on/off>
--	---

Example

```
P2121# configure
P2121(config)#
P2121(config)# schedule index 1 how-often cycle-days 3 start-date jan 1 2019
start-time 08:01 duraton 17:30 action on
P2121(config)# schedule index 2 how-often weekdays sun start-date may 11 2019
start-time 02:10 duration 12:10 action on
P2121(config)#
```

Telnet Command: snmp

Use this command to define SNMP community.

Syntax Items

```
snmp community
snmp engineid
snmp group
snmp host
snmp trap
snmp user
snmp view
```

Description

Syntax Items	Description
<i>snmp community</i>	<p>snmp community - Set community name for SNMP v1 and v2, and access group name.</p> <p>Available parameters for SNMP community:</p> <p><NAME> after community - Enter a string (maximum length: 20 characters) as community name.</p>

	<p><NAME> after group - Enter a string (maximum length: 30 characters) as access group.</p> <p>ro - Set the community as read only.</p> <p>rw - Set the community as read and write.</p> <p>Related Syntax:</p> <ul style="list-style-type: none"> ● <config># snmp community <NAME> group <NAME> ● <config># snmp community <NAME> ro ● <config># snmp community <NAME> rw ● <config># snmp community <NAME> view <NAME> ro ● <config># snmp community <NAME> view <NAME> rw
<i>snmp engineid</i>	<p>snmp engineid - Set the remote host for SNMP engine.</p> <p>default - Reset to default setting of engine ID for SNMP server.</p> <p><ENGINEID> - Such number must be 10 ~ 64 hexadecimal.</p> <p><A.B.C.D> - Enter the IP address of the remote SNMP server.</p> <p><HOSTNAME> - Enter the host name of the remote SNMP server.</p> <p><X:X::X:X> - Enter the IPv6 address for remote SNMP server.</p> <p>Related Syntax:</p> <ul style="list-style-type: none"> ● <config># snmp engineid <ENGINEID> ● <config># snmp engineid default ● <config># snmp engineid remote <A.B.C.D> <ENGINEID> ● <config># snmp engineid remote <HOSTNAME> <ENGINEID> ● <config># snmp engineid remote <X:X::X:X><ENGINEID>
<i>snmp group</i>	<p>snmp group - Set the SNMP group.</p> <p><NAME> - Specify the name of SNMP group.</p> <p>version <1/2c/3> - Specify the version of SNMP service.</p> <p><auth/noauth/priv> - Specify the packet authentication mode. "auth" means to perform packet authentication without encryption. It is applicable for SNMPv3 only. "noauth" means no packet authentication performed. "priv" means to perform packet authentication with encryption and also it is applicable for SNMPv3 only.</p> <p>read-view <NAME> - Set the view name to enable agent configuration.</p> <p>notify-view <NAME> - Set the view name to send only trap included in SNMP view for notification.</p> <p>write-view <NAME> - Set the view name to enable viewing.</p> <p>Related Syntax:</p> <ul style="list-style-type: none"> ● <config># snmp group <NAME> version <1/2c/3> <auth/noauth/priv> read-view <NAME> ● <config># snmp group <NAME> version <1/2c/3> <auth/noauth/priv> read-view <NAME> notify-view <NAME> ● <config># snmp group <NAME> version <1/2c/3> <auth/noauth/priv> read-view <NAME> notify-view <NAME> write-view <NAME>
<i>snmp host</i>	<p>snmp host - Set a host to receive SNMP notifications.</p> <p><A.B.C.D> - Enter the IPv4/IPv6 address or host name of the receipt.</p> <p>version <1/2c/3> - Specify the version of SNMP service.</p> <p><NAME> - Set the community name sent with the notification.</p> <p>udp-port <1-65535> - Set the UDP port number.</p> <p>timeout <1-300> - Set the timeout of V2c informs.</p> <p>retries <1-255> - Enter the retry counter of V2c informs.</p> <p>Related Syntax:</p>

Set a host to receive SNMP notifications.

- <config># snmp host <A.B.C.D> <NAME> retries <1-255>
- <config># snmp host <A.B.C.D> <NAME> timeout <1-300> retries <1-255>
- <config># snmp host <A.B.C.D> <NAME> udp-port <1-65535> retries <1-255>
- <config># snmp host <A.B.C.D> <NAME> udp-port <1-65535> timeout <1-300>

Set a host to receive SNMP notifications. Notification type is informs.

- <config># snmp host <A.B.C.D> informs <NAME> retries <1-255>
- <config># snmp host <A.B.C.D> informs <NAME> timeout <1-300>
- <config># snmp host <A.B.C.D> informs <NAME> timeout <1-300> retries <1-255>
- <config># snmp host <A.B.C.D> informs <NAME> udp-port <1-65535>
- <config># snmp host <A.B.C.D> informs <NAME> udp-port <1-65535> retries <1-255>
- <config># snmp host <A.B.C.D> informs <NAME> udp-port <1-65535> timeout <1-300>
- <config># snmp host <A.B.C.D> informs <NAME> udp-port <1-65535> timeout <1-300> retries <1-255>
- <config># snmp host <A.B.C.D> informs version <1/2c/3>
- <config># snmp host <A.B.C.D> informs version <1/2c/3><NAME> retries <1-255>
- <config># snmp host <A.B.C.D> informs version <1/2c/3><NAME> timeout <1-300>
- <config># snmp host <A.B.C.D> informs version <1/2c/3><NAME> timeout <1-300> retries <1-255>
- <config># snmp host <A.B.C.D> informs version <1/2c/3><NAME> udp-port <1-65535>
- <config># snmp host <A.B.C.D> informs version <1/2c/3><NAME> udp-port <1-65535> retries <1-255>
- <config># snmp host <A.B.C.D> informs version <1/2c/3><NAME> udp-port <1-65535> timeout <1-300>
- <config># snmp host <A.B.C.D> informs version <1/2c/3><NAME> udp-port <1-65535> timeout <1-300> retries <1-255>

Set a host to receive SNMP notifications. Notification type is traps.

- <config># snmp host <A.B.C.D> traps <NAME>
- <config># snmp host <A.B.C.D> traps <NAME> retries <1-255>
- <config># snmp host <A.B.C.D> traps <NAME> timeout <1-300>
- <config># snmp host <A.B.C.D> traps <NAME> timeout <1-300> retries <1-255>
- <config># snmp host <A.B.C.D> traps version <1/2c/3><NAME> retries <1-255>
- <config># snmp host <A.B.C.D> traps version <1/2c/3><NAME> timeout <1-300> retries <1-255>
- <config># snmp host <A.B.C.D> traps version <1/2c/3><NAME> udp-port <1-65535>
- <config># snmp host <A.B.C.D> traps version <1/2c/3><NAME> udp-port <1-65535> retries <1-255>
- <config># snmp host <A.B.C.D> traps version <1/2c/3><NAME> udp-port <1-65535> timeout <1-300>
- <config># snmp host <A.B.C.D> traps version <1/2c/3><NAME> udp-port <1-65535> timeout <1-300> retries <1-255>

- <config># snmp host <A.B.C.D> version <1/2c/3><NAME> retries <1-255>
- <config># snmp host <A.B.C.D> version <1/2c/3><NAME> timeout <1-300>
- <config># snmp host <A.B.C.D> version <1/2c/3><NAME> timeout <1-300> retries <1-255>
- <config># snmp host <A.B.C.D> version <1/2c/3><NAME> udp-port <1-65535>
- <config># snmp host <A.B.C.D> version <1/2c/3><NAME> udp-port <1-65535> retries <1-255>
- <config># snmp host <A.B.C.D> version <1/2c/3><NAME> udp-port <1-65535> timeout <1-300>
- <config>#snmp host <A.B.C.D> version <1/2c/3><NAME> udp-port <1-65535> timeout <1-300> retries <1-255>

- <config># snmp host HOSTNAME <NAME>
- <config># snmp host HOSTNAME <NAME> retries <1-255>
- <config># snmp host HOSTNAME <NAME> timeout <1-300>
- <config># snmp host HOSTNAME <NAME> timeout <1-300> retries <1-255>
- <config># snmp host HOSTNAME <NAME> udp-port <1-65535>
- <config># snmp host HOSTNAME <NAME> udp-port <1-65535> retries <1-255>
- <config># snmp host HOSTNAME <NAME> udp-port <1-65535> timeout <1-300>
- <config># snmp host HOSTNAME <NAME> udp-port <1-65535> timeout <1-300> retries <1-255>

- <config># snmp host HOSTNAME informs <NAME>
- <config># snmp host HOSTNAME informs <NAME> retries <1-255>
- <config># snmp host HOSTNAME informs <NAME> timeout <1-300>
- <config># snmp host HOSTNAME informs <NAME> retries <1-255> timeout <1-300> retries <1-255>
- <config># snmp host HOSTNAME informs <NAME> udp-port <1-65535>
- <config># snmp host HOSTNAME informs <NAME> udp-port <1-65535> retries <1-255>
- <config># snmp host HOSTNAME informs <NAME> udp-port <1-65535> timeout <1-300>
- <config># snmp host HOSTNAME informs <NAME> udp-port <1-65535> timeout <1-300> retries <1-255>

- <config># snmp host HOSTNAME traps <NAME>
- <config># snmp host HOSTNAME traps <NAME> retries <1-255>
- <config># snmp host HOSTNAME traps <NAME> timeout <1-300>
- <config># snmp host HOSTNAME traps <NAME> timeout <1-300> retries <1-255>
- <config># snmp host HOSTNAME traps <NAME> udp-port <1-65535>
- <config># snmp host HOSTNAME traps <NAME> udp-port <1-65535> retries <1-255>
- <config># snmp host HOSTNAME traps <NAME> udp-port <1-65535> timeout <1-300>
- <config># snmp host HOSTNAME traps <NAME> udp-port <1-65535> timeout <1-300> retries <1-255>
- <config># snmp host HOSTNAME traps version <1/2c/3> <NAME> retries <1-255>
- <config># snmp host HOSTNAME traps version <1/2c/3> <NAME> timeout <1-300>
- <config># snmp host HOSTNAME traps version <1/2c/3>

	<p><1-65535> retries <1-255></p> <ul style="list-style-type: none"> ● <config># snmp host <X::X:X> traps <NAME> udp-port <1-65535> timeout <1-300> ● <config># snmp host <X::X:X> traps <NAME> udp-port <1-65535> timeout <1-300> retries <1-255> ● <config># snmp host <X::X:X> version <1/2c/3> <NAME> ● <config># snmp host <X::X:X> version <1/2c/3> <NAME> retries <1-255> ● <config># snmp host <X::X:X> version <1/2c/3> <NAME> timeout <1-300> ● <config># snmp host <X::X:X> version <1/2c/3> <NAME> timeout <1-300> retries <1-255> ● <config># snmp host <X::X:X> version <1/2c/3> <NAME> udp-port <1-65535> ● <config># snmp host <X::X:X> version <1/2c/3> <NAME> udp-port <1-65535> retries <1-255> ● <config># snmp host <X::X:X> version <1/2c/3> <NAME> udp-port <1-65535> timeout <1-300> ● <config># snmp host <X::X:X> version <1/2c/3> <NAME> udp-port <1-65535> timeout <1-300> retries <1-255>
<i>snmp trap</i>	<p>snmp trap - Send the SNMP traps.</p> <p>auth - Enable the SNMP authentication failure trap.</p> <p>cold-start - Enable the SNMP cold startup failure trap.</p> <p>linkUpDown - Enable the SNMP link up and down failure trap.</p> <p>wort-security - Enable the SNMP port security trap.</p> <p>Warm-start - Enable the SNMP warm startup failure trap.</p> <p>Related Syntax:</p> <ul style="list-style-type: none"> ● <config># snmp trap <auth / cold-start / linkUpDown / port-security / warm-start>
<i>snmp user</i>	<p>snmp user - Set SNMP user account.</p> <p><username> - Specify a name of SNMP user.</p> <p><groupName> - Sepcify a name of SNMP group.</p> <p>auth <md5/sha> - Specify the authentication mode, md5 or sha.</p> <p><AUTHPASSWD> - Enter the password for the md5/sha mode.</p> <p>Pri <PRIVPASSWD> - Enter a password as a privacy key.</p> <p>Related Syntax:</p> <ul style="list-style-type: none"> ● <config># snmp user <username> <groupName> ● <config># snmp user <username> <groupName> auth <md5/sha> <AUTHPASSWD> ● <config># snmp user <username> <groupName> auth <md5/sha> <AUTHPASSWD> priv <PRIVPASSWD>
<i>snmp view</i>	<p>snmp view - Set the SNMP view.</p> <p><NAME> - Enter the SNMP view name.</p> <p>Subtree <OID> - Specify the ASN.1 subtree object identifier (OID).</p> <p>oid-mask <mask/all> - Speicfy the OID mask, or use all for all masks.</p> <p>viewtype <excluded/included> - Let the selected MIBs include or exclude in the SNMP view.</p> <p>Related Syntax:</p> <ul style="list-style-type: none"> ● <config># snmp view <NAME> subtree <OID> oid-mask <mask> viewtype <excluded/included>

Example

```
P2121# configure
```



```

P2121(config)#
P2121(config)# snmp engineid remote 192.168.2.38 00036D001188
P2121(config)# snmp engineid remote 00:50::16:88 00036D002288
P2121(config)# snmp host 192.168.2.89 CAR_community udp-port 1500 timeout 200
P2121(config)# snmp host 192.168.2.88 informs version 2c CAR_community
udp-port 3000 timeout 180 retries 35
P2121(config)# snmp host 192.168.2.88 traps version 2c CAR_traps udp-port 6500
timeout 60 retries 2
P2121(config)# snmp host 192.168.2.88 version 2c CAR_version udp-port 3000
timeout 60 retries 2
P2121(config)# snmp host HOSTNAME CAR_host udp-port 3000 timeout 60 retries
P2121(config)# snmp host HOSTNAME informs HA_informs udp-port 3000 timeout 60
retries 2
P2121(config)# snmp host HOSTNAME version 2c HT_verstion udp-port 3000 timeout
60 retries 2
P2121(config)# snmp user CA_user_1 CA_group_1 auth md5 CA12345678 priv
PR12345678
P2121(config)# snmp view CAR_community subtree 10 oid-mask 9 viewtype included
P2121(config)#

```

Telnet Command: sntp

Use this command to configure settings for remote SNMP server.

Syntax Items

snmp host

Description

Syntax Items	Description
<i>snmp host</i>	<p>Set the remote SNMP server by specifying IP address or hostname. <HOSTNAME> - Enter the IP address or hostname of SNMP server. <1-65535> - Specify the port number for the SNMP server.</p> <p>Related Syntax:</p> <ul style="list-style-type: none"> ● <config># snmp host <HOSTNAME> ● <config># snmp host <HOSTNAME> port <1-65535>

Example

```

P2121# configure
P2121(config)#
P2121(config)# snmp host KEY1245 port 3000
P2121(config)#

```

Telnet Command: spanning-tree

Use this command to configure settings for spanning-tree.

Syntax Items

spanning-tree
spanning-tree bpdu
spanning-tree forward-delay
spanning-tree hello-time
spanning-tree max-hops

spanning-tree maximum-age
spanning-tree mode
spanning-tree mst
spanning-tree pathcost
spanning-tree priority
spanning-tree tx-hold-count

Description

Syntax Items	Description
<i>spanning-tree</i>	Enable the function of spanning-tree. Related Syntax: <ul style="list-style-type: none"> ● <config># spanning-tree
<i>spanning-tree bpdu</i>	Filter/flood the BPDU packets. <filtering> - Packets will be filtered when STP is disabled on specified interface. <flooding> - Packets will be flooded to all interfaces with STP disabled and flooding mode. Related Syntax: <ul style="list-style-type: none"> ● <config># spanning-tree bpdu<filtering/flooding>
<i>spanning-tree forward-delay</i>	Set the STP forward delay time. <4-30> - Default value is 15 (seconds). Related Syntax: <ul style="list-style-type: none"> ● <config># spanning-tree forward-delay <4-30>
<i>spanning-tree hello-time</i>	Set the hello time interval to broadcast the message to other bridges. <1-10> - Default value is 2 (seconds). Related Syntax: <ul style="list-style-type: none"> ● <config># spanning-tree hello-time <1-10>
<i>spanning-tree max-hops</i>	Set the number of hops for BPDU packets to be forwarded in the MSTP region. <1-40> - Default value is 20 (seconds). Related Syntax: <ul style="list-style-type: none"> ● <config># spanning-tree max-hops <1-40>
<i>spanning-tree maximum-age</i>	Set the time interval for VigorSwitch to wait without receiving the configuration message. <6-40> - Default value is 20 (seconds). Related Syntax: <ul style="list-style-type: none"> ● <config># spanning-tree maximum-age <6-40>
<i>spanning-tree mode</i>	<mstp/rstp/stp> - Specify the operation mode for spanning tree, such as multiple spanning tree (MSTP), rapid spanning tree (RSTP) or spanning tree (STP). Related Syntax: <ul style="list-style-type: none"> ● <config># spanning-tree mode <mstp/rstp/stp>
<i>spanning-tree mst</i>	<i>spanning-tree mst</i> - Configure port priority settings for MST. <0-15> - Specify the instance ID. <0-61440> - Set the priority for the specified instance ID. Related Syntax: <ul style="list-style-type: none"> ● <config># spanning-tree mst <0-15> priority <0-61440>

	<p>spanning-tree mst configuration - Access into the MSTP configuration mode. To configure detailed settings, access into next level.</p> <pre><config># spanning-tree mst configuration <config-mst>#</pre> <p>Then, available sub-commands are:</p> <pre><config-mst>#do <config-mst># end <config-mst># exit <config-mst># instance <config-mst># name <config-mst># no <config-mst># revision</pre> <p>do <SEQUENCE> - Enter the action to be performed. end - End current mode. exit - Exit from current mode. instance <0-15> vlan <1-4094> - Specify the instance ID number and VLAN ID number. name <NAME> - Set a name of MST configuration. no - Set to default setting. revision <0-65535> - Set revision level.</p>
<i>spanning-tree pathcost</i>	<p>Set the path-cost method for spanning tree.</p> <p><long/short> - Long means the path cost ranging from 1 to 200000000; short means the path cost ranging from 1 to 65535.</p> <p>Related Syntax:</p> <ul style="list-style-type: none"> ● <config># spanning-tree pathcost method <long/short>
<i>spanning-tree priority</i>	<p>Set the priority for the specified instance ID.</p> <p><0-61440> - The number must be multiple of 4096.</p> <p>Related Syntax:</p> <ul style="list-style-type: none"> ● <config># spanning-tree priority <0-61440>
<i>spanning-tree tx-hold-count</i>	<p>Set the maximum number of packets transmission per second.</p> <p><1-10> - Valid range is from 1 to 10.</p> <p>Related Syntax:</p> <ul style="list-style-type: none"> ● <config># spanning-tree tx-hold-count <1-10>

Example

```
P2121# configure
P2121(config)#
P2121(config)# spanning-tree forward-delay 20
P2121(config)#
P2121(config)# spanning-tree maximum-age 38
P2121(config)#
P2121(config)# spanning-tree tx-hold-count 3
P2121(config)#
```

Telnet Command: start-up

Use this command to restart ICP status after rebooting VigorSwitch.

Syntax Items

start-up icp

Description

Syntax Items	Description
<i>start-up icp</i>	Related Syntax: <ul style="list-style-type: none">● <config># start-up icp enable

Example

```
P2121# configure
P2121(config)#
P2121(config)# start-up icp enable
P2121(config)#
```

Telnet Command: storm-control

Use this command to configure settings for Storm Control.

Syntax Items

storm-control ifg exclude
storm-control ifg include
storm-control unit bps
storm-control unit pps

Description

Syntax Items	Description
<i>storm-control ifg exclude</i>	Exclude the preamble and IFG (inter frame gap) into the calculating. Related Syntax: <ul style="list-style-type: none">● <config># storm-control ifg exclude
<i>storm-control ifg include</i>	Include the preamble and IFG (inter frame gap) into the calculating. Related Syntax: <ul style="list-style-type: none">● <config># storm-control ifg include
<i>storm-control unit bps</i>	Change the unit of calculating method for storm-control. bps - Calculate the storm control rate by octet-based. Related Syntax: <ul style="list-style-type: none">● <config># storm-control unit bps
<i>storm-control unit pps</i>	Change the unit of calculating method for storm-control. pps - Calculate the storm control rate by packet-based. Related Syntax: <ul style="list-style-type: none">● <config># storm-control unit pps

Example

```
P2121# configure
P2121(config)#
P2121(config)# storm-control ifg exclude
P2121(config)#
P2121(config)# storm-control unit bps
P2121(config)#
```

Telnet Command: surveillance-vlan

Use this command to configure settings for surveillance-VLAN.

Syntax Items

surveillance-vlan
surveillance-vlan aging-time
surveillance-vlan cos
surveillance-vlan oui-table
surveillance-vlan vlan

Description

Syntax Items	Description
<i>surveillance-vlan</i>	Enable the function of surveillance VLAN on VigorSwitch. Related Syntax: <ul style="list-style-type: none">● <config># surveillance-vlan
<i>surveillance-vlan aging-time</i>	Set the aging time for surveillance VLAN. <30-65536> - Enter a value as aging time. Related Syntax: <ul style="list-style-type: none">● <config># surveillance-vlan aging-time <30-65536>
<i>surveillance-vlan cos</i>	Set the class of service (0~7) for surveillance VLAN. <0-7>- Enter a number. Related Syntax: <ul style="list-style-type: none">● <config># surveillance-vlan cos <0-7> remark
<i>surveillance-vlan oui-table</i>	Enable OUI surveillance VLAN configuration for specified interface. <A:B:C> - Enter the OUI address (e.g., 00:50:12). <DESCRIPTION> - Enter a string to briefly explain the surveillance VLAN. Related Syntax: <ul style="list-style-type: none">● <config># surveillance-vlan oui-table <A:B:C> <DESCRIPTION>
<i>surveillance-vlan vlan</i>	Specify a VLAN profile as surveillance VLAN. <2-4094> - Specify the surveillance VLAN ID. Related Syntax: <ul style="list-style-type: none">● <config># surveillance-vlan vlan <2-4094>

Example

```
P2121# configure
P2121(config)#
P2121(config)#
P2121(config)# surveillance-vlan aging-time 60
P2121(config)#
P2121(config)# surveillance-vlan oui-table 00:50:12 fortestonly
P2121(config)#
```

Telnet Command: system

Use this command to modify the contact information of VigorSwitch.

Syntax Items

system contact

system location

system name

Description

Syntax Items	Description
<i>system contact</i>	<CONTACT> - Enter a string (maximum length: 256 characters). Related Syntax: <ul style="list-style-type: none">● <config># system contact <CONTACT>
<i>system location</i>	<LOCATION> - Specify the location of the host. Related Syntax: <ul style="list-style-type: none">● <config># system location <LOCATION>
<i>system name</i>	<NAME> - Change the name of the system. The default name is "P2121". Related Syntax: <ul style="list-style-type: none">● <config># system name <NAME>

Example

```
P2121# configure
P2121(config)#
P2121(config)# system contact callMIS
P2121(config)#
P2121(config)# system location DrayTek
P2121(config)# system name UPDATEFRIM
UPDATEFRIM(config)#
```

Telnet Command: tacacs

Use this command to configure TACACS+ server.

Syntax Items

tacacs default-config

tacacs host

Description

Syntax Items	Description
<i>tacacs default-config</i>	Set the default parameters for the TACACS+ server. Modify the default parameters of server key and timeout setting for the TACACS+ server. <TACPLUSKEY> - Enter a string as the TACACS+ server key. <1-30> - Enter a value as the TACACS+ server timeout. Related Syntax: <ul style="list-style-type: none">● <config># tacacs default-config

	<ul style="list-style-type: none"> • <config># tacacs default-config key <TACPLUSKEY> • <config># tacacs default-config key <TACPLUSKEY> timeout <1-30>
<i>tacacs host</i>	<p>Set host name for the TACACS+ server or set host name, server key and priority for the TACACS+ server.</p> <p><HOSTNAME> - Enter the host name of the TACACS+ server. <TACPLUSKEY> - Enter a string as the TACACS+ server key. <0-65535> - Enter a value as server priority in server group. <1-30> - Enter a timeout setting.</p> <p>Related Syntax:</p> <ul style="list-style-type: none"> • <config># tacacs host <HOSTNAME> • <config># tacacs host <HOSTNAME> key <TACPLUSKEY> • <config># tacacs host <HOSTNAME> key <TACPLUSKEY> priority <0-65535> • <config># tacacs host <HOSTNAME> key <TACPLUSKEY> priority <0-65535> timeout <1-30>

Example

```
P2121# configure
P2121(config)#
P2121(config)# tacacs default-config key tce00056 timeout 25
P2121(config)#
P2121(config)# tacacs host carrie02 key TA012345 priority 3000 timeout 10
P2121(config)#
```

Telnet Command: tr069

Use this command to configure parameter settings of TR-069.

Syntax Items

tr069 acsPwd
tr069 acsUsername
tr069 acsurl
tr069 cpeEnable
tr069 cpePwd
tr069 cpeUsername
tr069 cpeport
tr069 healthlinkstatus
tr069 healthpoewarning
tr069 healthspeedstatus
tr069 periodicInfo
tr069 periodicTime Time
tr069 ssl
tr069 stun
tr069 stunMAXkeepalive
tr069 stunMINkeepalive
tr069 stunaddr
tr069 stunport
tr069 tls

Description

Syntax Items	Description
<i>tr069 acsPwd</i>	<PASSWORD> - Enter the password used for registering to VigorACS server.

	<p>Related Syntax:</p> <ul style="list-style-type: none"> ● <config># tr069 acsPwd<PASSWORD>
<i>tr069 acsUsername</i>	<p><NAME> - Enter the username used for registering to VigorACS server.</p> <p>Related Syntax:</p> <ul style="list-style-type: none"> ● <config># tr069 acsUsername<NAME>
<i>tr069 acsurl</i>	<p><ADDRESS> - Enter the URL for VigorACS server.</p> <p>Related Syntax:</p> <ul style="list-style-type: none"> ● <config># tr069 acsurl <ADDRESS>
<i>tr069 cpeEnable</i>	<p><disable/enable> - Enter Enable for VigorACS controlling such CPE through the Internet.</p> <p>Related Syntax:</p> <ul style="list-style-type: none"> ● <config># tr069 cpeEnable <disable/enable>
<i>tr069 cpePwd</i>	<p><PASSWORD> - Enter the password that VigorACS server can use it to authenticate and control the CPE device.</p> <p>Related Syntax:</p> <ul style="list-style-type: none"> ● <config># tr069 cpePwd <PASSWORD>
<i>tr069 cpeUsername</i>	<p><NAME> - Enter the username that VigorACS server can use it to authenticate and control the CPE device.</p> <p>Related Syntax:</p> <ul style="list-style-type: none"> ● <config># tr069 cpeUsername <NAME>
<i>tr069 cpeport</i>	<p><0-65535> - Enter the port number for CPE.</p> <p>Related Syntax:</p> <ul style="list-style-type: none"> ● <config># tr069 cpeport <0-65535>
<i>tr069 healthlinkstatus</i>	<p>Perform the health check for the link status of specified interface(s).</p> <p><PORTLIST> - Specify the interface, such as GE1, GE3-GE5 and so on.</p> <p>Related Syntax:</p> <ul style="list-style-type: none"> ● <config># tr069 healthlinkstatus <PORTLIST>
<i>tr069 healthpoewarning</i>	<p>Perform the health check for PoE port warning status.</p> <p><PORTLIST> - Specify the interface, such as GE1, GE3-GE5 and so on.</p> <p>Related Syntax:</p> <ul style="list-style-type: none"> ● <config># tr069 healthpoewarning <PORTLIST>
<i>tr069 healthspeedstatus</i>	<p>Perform the health check for link speed status of specified interface(s).</p> <p><PORTLIST> - Specify the interface, such as GE1, GE3-GE5 and so on.</p> <p>Related Syntax:</p> <ul style="list-style-type: none"> ● <config># tr069 healthspeedstatus <PORTLIST>
<i>tr069 periodicInfo</i>	<p><disable/enable> - Enter Enable to activate periodic information setting.</p> <p>Related Syntax:</p> <ul style="list-style-type: none"> ● <config># tr069 periodicInfo <disable/enable>
<i>tr069 periodicTime TIME</i>	<p>Update the CPE information to VigorACS server.</p>

	<p>Related Syntax:</p> <ul style="list-style-type: none"> ● <config># tr069 periodicTime TIME
<i>tr069 ssl</i>	<p><disable/enable> - Enter Enable to enable CPE management protocol with SSL.</p> <p>Related Syntax:</p> <ul style="list-style-type: none"> ● <config># tr069 ssl <disable/enable>
<i>tr069 stun</i>	<p><disable/enable> - Enter Enable to enable CPE management protocol with STUN server.</p> <p>Related Syntax:</p> <ul style="list-style-type: none"> ● <config># tr069 stun <disable/enable>
<i>tr069 stunMAXkeepalive</i>	<p>Set the maximum time period for CPE to send the binding request to VigorACS server.</p> <p><0-65535> - Enter a number.</p> <p>Related Syntax:</p> <ul style="list-style-type: none"> ● <config># tr069 stunMAXkeepalive <0-65535>
<i>tr069 stunMINkeepalive</i>	<p>Set the minimum time period for CPE to send the binding request to VigorACS server.</p> <p><0-65535> - Enter a number.</p> <p>Related Syntax:</p> <ul style="list-style-type: none"> ● <config># tr069 stunMINkeepalive <0-65535>
<i>tr069 stunaddr</i>	<p><ADDRESS> - Enter the URL/IP address of STUN server.</p> <p>Related Syntax:</p> <ul style="list-style-type: none"> ● <config># tr069 stunaddr <ADDRESS>
<i>tr069 stunport</i>	<p><0-65535> - Set the port number for STUN server.</p> <p>Related Syntax:</p> <ul style="list-style-type: none"> ● <config># tr069 stunport <0-65535>
<i>tr069 tls</i>	<p><tls1.2/tls1.3> - Set the TLS version (2 or 3) for VigorSwitch.</p> <p>Related Syntax:</p> <ul style="list-style-type: none"> ● <config># tr069 tls version <tls1.2/tls1.3>

Example

```
P2121# configure
P2121(config)#
P2121(config)# tr069 stunaddr 192.168.3.99
P2121(config)#
```

Telnet Command: udd

Use this command to set the time interval of UniDirectional Link Detection (UDLD) sent message.

Syntax Items

udd

Description

Syntax Items	Description
--------------	-------------

<i>udld message time</i>	<p><1-90> - Specify a time interval for sending message.</p> <p>Related Syntax:</p> <ul style="list-style-type: none"> ● <config>#udld message time <1-90>
--------------------------	--

Example

```
P2121# configure
P2121(config)# udld message time 35
P2121(config)#
```

Telnet Command: username

Use this command to add a new user account or edit an existing user account.

Syntax Items

username

Description

Syntax Items	Description
<i>username</i>	<p>privilege - Set a user account with the privilege of admin, user or customized level.</p> <p>secret - Set a user account with unencrypted password.</p> <p>secret encrypted - Set a user account with encrypted password.</p> <p><WORD> - Enter the name (0~32 characters) of the local user profile.</p> <p><admin/ user> - Specify the privilege level to be admin (privilege 15) / user (privilege 1).</p> <p><PASSWORD> - Enter a string as the password for the local user.</p> <p>Related Syntax:</p> <ul style="list-style-type: none"> ● <config># username <WORD> privilege <admin/user> secret <PASSWORD> ● <config># username <WORD> secret <PASSWORD> ● <config># username <WORD> secret encrypted <PASSWORD>

Example

```
P2121# configure
P2121(config)#
P2121(config)# username carrie_1 privilege admin secret md123456
P2121(config)#
P2121(config)# username carrie_1 secret encrypted ca123456
Old password: *****
P2121(config)#
```

Telnet Command: vlan

Use this command to configure detailed settings for VLAN profile.

Before configuring, you have to access into next phase. See the following example:

```
P2121# configure
P2121(config)#
P2121(config)# vlan 3
P2121(config-vlan)#
```

Syntax Items

vlan vlan-list
 vlan mac-vlan group
 vlan protocol-vlan group

Description

Syntax Items	Description
<i>vlan</i>	<p>Specify the index number of VLAN profile. To configure detailed settings, access into next level.</p> <p><vlan-list> - The available range is 1 to 4094.</p> <pre><config># vlan 33 <config-vlan>#</pre> <p>Then, available sub-commands are:</p> <pre><config-vlan>#do <config-vlan>#end <config-vlan>#exit <config-vlan>#name</pre> <hr/> <p>Use the “do” command to run execution command in current mode.</p> <p><SEQUENCE> -</p> <p>Related Syntax:</p> <ul style="list-style-type: none"> ● <config-vlan>#do <SEQUENCE> <hr/> <p>Use the “end” command to finish current mode. Any changes in current mode will be saved.</p> <p>Related Syntax:</p> <ul style="list-style-type: none"> ● <config-vlan>#end <hr/> <p>Use the “exit” command to close the current CLI session or return to the previous mode without saving the settings.</p> <p>Related Syntax:</p> <ul style="list-style-type: none"> ● <config-macl>#exit <hr/> <p>Use the “name” command to add a VLAN profile.</p> <p><string> - Enter the name of the VLAN profile.</p> <p>Related Syntax:</p> <ul style="list-style-type: none"> ● <config-vlan>#name <string>
<i>vlan mac-vlan group</i>	<p>Create a MAC-vlan group.</p> <p><1-2147483647> - Specify a group ID.</p> <p><A:B:C:D:E:F> - Enter the MAC address to be mapped.</p> <p><9-48> - Enter a number representing the subnet mask.</p> <p>Related Syntax:</p> <ul style="list-style-type: none"> ● <config># vlan mac-vlan group <1-2147483647> <A:B:C:D:E:F> mask <9-48>
<i>vlan protocol-vlan group</i>	<p>Create a protocol VLAN group with specified protocol type and value.</p> <p><1-8> - Enter a number to specify a VLAN group.</p> <p><Ethernet_ii/ 11c_other/snap_1042> - Specify a frame type by entering Ethernet_ii, 11c_other or snap_1042.</p> <p><value> - Enter a value (0x0600-0xFFFE).</p> <p>Related Syntax:</p> <ul style="list-style-type: none"> ● <config># vlan protocol-vlan group <1-8> frame-type <Ethernet_ii/ 11c_other/snap_1042> protocol-value <value>

Example

```
P2121# configure
P2121(config)# vlan 3
P2121(config-vlan)#
P2121(config-vlan)# name vlan_friends
P2121(config-vlan)#
...
P2121(config)# vlan mac-vlan group 33 00:50:17:22:12:ff mask 10
P2121(config)# vlan group 1 frame-type ethernet_ii protocol-value 0x0600
P2121(config)#
```

Telnet Command: voice-vlan

Use this command to enable voice VLAN and configure settings for voice VLAN.

Syntax Items

voice-vlan aging-time
voice-vlan cos
voice-vlan oui-table
voice-vlan vlan

Description

Syntax Items	Description
<i>voice-vlan aging-time</i>	<p>Set the voice VLAN aging timeout interval. <30-65536> - The unit is minute. Default is 1440 (minutes). <string> - Enter the name of the VLAN profile.</p> <p>Related Syntax:</p> <ul style="list-style-type: none">● <config># voice-vlan aging-time <30-65536>
<i>voice-vlan cos</i>	<p>Set the voice VLAN cos value and remark function. Specify the class of service for voice VLAN. <0-7> - CoS value. Default is 6. Remark is disabled. remark - L2 user priority is remarked with the CoS value.</p> <p>Related Syntax:</p> <ul style="list-style-type: none">● <config># voice-vlan cos <0-7> remark
<i>voice-vlan oui-table</i>	<p>Add or remove the selected OUI to/from the OUI table. In default, there are 8 OUI addresses. <A:B:C> - Enter the OUI address. <DESCRIPTION> - Enter a brief description for the specified MAC address to the voice VLAN OUI table.</p> <p>Related Syntax:</p> <ul style="list-style-type: none">● <config># voice-vlan cos <0-7> remark
<i>voice-vlan vlan</i>	<p>Set the VLAN identifier of the voice VLAN. <2-4094> - Enter the number of VLAN ID.</p> <p>Related Syntax:</p> <ul style="list-style-type: none">● <config># voice-vlan vlan <2-4094>

Example

```
P2121# configure
P2121(config)# voice-vlan aging-time 1000
P2121(config)#
P2121(config)# voice-vlan oui-table 22:30:ff test_01
```

```

P2121(config)#
P2121(config)# voice-vlan oui-table 00:01:E2 STAMP
P2121(config)# exit
P2121# show voice-vlan interfaces gigabitEthernet 1
Voice VLAN Aging      : 1000 minutes
Voice VLAN CoS       : 6
Voice VLAN lp Remark: disabled

OUI table
  OUI MAC | Description
-----+-----
  00:E0:BB | 3COM
  00:03:6B | Cisco
  00:E0:75 | Veritel
  00:D0:1E | Pingtel
  00:01:E3 | Siemens
  00:60:B9 | NEC/Philips
  00:0F:E2 | H3C
  00:09:6E | Avaya
  22:30:FF | test_01
  00:01:E2 | STAMP

  Port | State | Port Mode | Cos Mode
-----+-----+-----+-----
  gil  | Disabled | Auto | Src
P2121#

```

Telnet Command: webhook

Use this command to enable or disable the webhook service.

Syntax Items

`webhook active`

`webhook host`

`webhook interval`

`webhook keep`

Description

Syntax Items	Description
<code>webhook active</code>	<p><enable/disable> - Enable or disable the webhook application.</p> <p>Related Syntax:</p> <ul style="list-style-type: none"> ● <code><config># webhook active <enable/disable></code>
<code>webhook host</code>	<p>Specify the destination (URL, domain name, IP address) to receive the data transferred by VigorSwitch.</p> <p><code>ip <ADDRESS></code> - Enter the IP address of the destination.</p> <p><code>path <PATH></code> - Enter the path string (part of the composition of the URL) of the destination.</p> <p><code>port <number></code> - Enter a port number.</p> <p><code>service <http/https></code> - Specify the protocol (http or https) of the destination.</p> <p><code>url <domain name></code> - Enter the domain name (e.g., draytek.com) of the destination. Note that it is not necessary to enter this information if IP address has been set first.</p> <p>Related Syntax:</p> <ul style="list-style-type: none"> ● <code><config># webhook host ip <ADDRESS></code> ● <code><config># webhook host path <PATH></code> ● <code><config># webhook host port <number></code>

	<ul style="list-style-type: none"> ● <config># webhook host service <http/https> ● <config># webhook host url <domain name>
<i>webhook interval</i>	<p><1-60> - Set the transmission interval (unit is minute).</p> <p>Related Syntax:</p> <ul style="list-style-type: none"> ● <config># webhook interval <1-60>
<i>webhook keep</i>	<p>settings <enable/disable> - Enable or disable the function of keep webhook settings.</p> <p>Related Syntax:</p> <ul style="list-style-type: none"> ● <config># webhook keep settings <enable/disable>

Example

```
P2121# configure
P2121(config)# webhook host service https
P2121(config)# webhook host url www.demo.com
P2121(config)# webhook host path Draytek/demo
P2121(config)# webhook host port 443
P2121(config)# webhook interval 2
```

XI-2-4 Copy Configuration

Use this command to upgrade firmware image, configuration file, syslog file, language file and security certificate.

Syntax Items

copy flash://

copy tftp://

copy backup-config

copy running-config

copy startup-config

Description

Syntax Items	Description
<i>copy flash://</i>	Related Syntax: <ul style="list-style-type: none">● # copy flash:// flash://● # copy flash:// tftp://
<i>copy running-config</i>	startup-config - Copy the running configuration file to startup configuration. tftp://- Copy the running configuration file to remote TFTP server with a filename. <IP address> - Enter the IP address of TFTP sever. <filename> - Create a name to save the configuration file. Related Syntax: <ul style="list-style-type: none">● # copy running-config backup-config● # copy running-config startup-config● # copy running-config tftp://
<i>copy startup-config</i>	running-config - Copy the startup configuration file to the running configuration. tftp://- Copy the startup configuration file to remote TFTP server with a filename. <IP address> - Enter the IP address of TFTP sever. <filename> - Create a name to save the configuration file. Related Syntax: <ul style="list-style-type: none">● # copy startup-config backup-config● # copy startup-config running-config● # copy startup-config tftp://
<i>copy tftp://</i>	Backup-config - Get the backup configuration from specified TFTP server. running-config - Get the running configuration from specified TFTP server. startup-config - Get the startup configuration from specified TFTP server. Related Syntax: <ul style="list-style-type: none">● # copy tftp:// backup-config● # copy tftp:// flash://● # copy tftp:// running-config● # copy tftp:// startup-config

- # copy tftp:// tftp://

Example

```
P2121# copy running-config tftp://172.16.3.8/test_carrie.cfg
Uploading file. Please wait...
Save configuration done.
P2121# copy startup-config tftp://172.16.3.8/test_da.cfg
Uploading file. Please wait...
Save configuration done.
P2121#
```

XI-2-5 Delete Configuration

Use this command to delete a file from the FLASH file system or restore the factory default settings of VigorSwitch.

Syntax Items

```
delete backup-config
delete flash:// startup-config
delete startup-config
delete system
```

Description

Syntax Items	Description
<i>delete backup-config</i>	Delete the backup configuration file in FLASH file system. Related Syntax: ● # delete backup-config
<i>delete flash://startup-config</i>	Delete the startup configuration file in FLASH file system. Related Syntax: ● # delete flash://startup-config
<i>delete startup-config</i>	Restore the factory default settings of VigorSwitch. Related Syntax: ● # delete startup-config
<i>delete system</i>	Delete the firmware image0/image1 stored in FLASH file system. <image0/image1> - Related Syntax: ● # delete system <image0/image1>

Example

```
P2121# delet flash://startup-config
Delete flash://startup-config [y/n] y
Do you want to reload the system to take effect? [y/n] y
```

...

XI-2-6 Disable Configuration

All commands used will be divided into EXEC mode and Privileged EXEC mode. This command is to turn off privileged mode command.

Default privilege level is 15 if no privilege level is specified on enable command.

Default privilege level is 1 if no privilege level is specified on disable command.

Syntax Items

disable

Description

Syntax Items	Description
disable	<1-14> - Enter a number to specify the privilege level. Related Syntax: <ul style="list-style-type: none">● # disable <1-14>

Example

```
P2121# disable ?
  <1-14> Privilege level
  <cr>
P2121# disable 3
P2121#
```

XI-2-7 End Configuration

Use this command to end current mode.

Syntax Items

end

Example

```
P2121(config)# interface GigabitEthernet 3
P2121(config-if)# end
P2121#
```

XI-2-8 Exit Configuration

Use this command to close current CLI session or return to previous mode.

Syntax Items

exit

Example

```
P2121(config)# interface GigabitEthernet 3
P2121(config-if)# exit
P2121(config)#
```

XI-2-9 Hardware-Monitor Configuration

Use this command to execute the hardware fan test.

Syntax Items

hardware-monitor fan-test

Example

```
P2121# hardware-monitor fan-test
P2121#
```

XI-2-10 Ping Configuration

Use this command to send ICMP ECHO_REQUEST to network hosts.

Syntax Items

ping

Description

Syntax Items	Description
<i>ping</i>	<HOSTNAME> - Enter an IPv4/IPv6 address or a domain name to ping. count <1-999999999> - Specify the number of repetitions of ping operation. Related Syntax: <ul style="list-style-type: none"># ping <HOSTNAME> count <1-999999999>

Example

```
P2121# ping 192.168.1.11 count 3
PING 192.168.1.11 (192.168.1.11): 56 data bytes
64 bytes from 192.168.1.11: icmp_seq=0 ttl=64 time=0.0 ms
64 bytes from 192.168.1.11: icmp_seq=1 ttl=64 time=0.0 ms
64 bytes from 192.168.1.11: icmp_seq=2 ttl=64 time=0.0 ms

--- 192.168.1.11 ping statistics ---
3 packets transmitted, 3 packets received, 0% packet loss
```

```
round-trip min/avg/max = 0.0/0.0/0.0 ms
P2121#
```

XI-2-11 Reboot Configuration

Use this command to perform a cold restart of VigorSwitch.

Syntax Items

reboot

Example

```
P2121# reboot
P2121#
```

XI-2-12 Renew Configuration

Use this command to renew DHCP Snooping database from backup file.

Syntax Items

renew ip dhcp snooping database

Example

```
P2121# renew ip dhcp snooping database
P2121#
```

XI-2-13 Restore-defaults Configuration

Use this command to restore the factory default settings for the system or for the selected port.

Syntax Items

restore-default

Description

Syntax Items	Description
<i>restore-default</i>	<1-12> - Enter the number (1 to 12) of LAN port. <1-8> - Enter the number of LAG port. Related Syntax: <ul style="list-style-type: none">● # restore-default● # restore-default interfaces GigabitEthernet <1-12>● # restore-default interfaces LAG <1-8>

Example

```
P2121# restore-defaults interfaces gigabitethernet 3
Interface gi3: restore factory defaults.
```

```
P2121#
P2121# restore-default
System: restore factory defaults. Do you want to reboot now? (y/n)y
```

XI-2-14 Save Configuration

Use this command to save configuration and activate the settings.

Note that this command has the same effect as "copy running-config startup-config".

Syntax Items

save

Example

```
P2121# save
Success
P2121#
```

XI-2-15 Show Configuration

After finished the command setting, use this command to display the configuration for all commands.

Syntax Items

show <command>

Example

```
P2121# show acl utilization
Type: sys                usage: 256
Type: IPSPG              usage: 128
Type: Auth                usage: 128
P2121#
P2121#
P2121# show arp
Address      HWtype  HWaddress      Flags Mask    Iface
192.168.1.55 ether   00:1D:AA:F0:26:08  C             eth0
192.168.1.10 ether   00:05:5D:E4:D8:EE  C             eth0
P2121# show voice-vlan interfaces gigabitethernet 3
Voice VLAN Aging      : 1440 minutes
Voice VLAN CoS       : 6
Voice VLAN lp Remark: disabled

OUI table
  OUI MAC  | Description
-----+-----
  00:E0:BB | 3COM
  00:03:6B | Cisco
  00:E0:75 | Veritel
```

```

00:D0:1E | Pingtel
00:01:E3 | Siemens
00:60:B9 | NEC/Philips
00:0F:E2 | H3C
00:09:6E | Avaya

Port | State | Port Mode | Cos Mode
-----+-----+-----+-----
gi3 | Disabled | Auto | Src
P2121#

```

XI-2-16 SSL Configuration

Use this command to generate security certificate files such as RSA, DSA.

After entering the command of SSL, follow the onscreen questions to give the required information.

Syntax Items

ssl

Example

```

P2121# ssl
Generating a 1024 bit RSA private key
.....+++++
.....+++++
writing new private key to '/mnt/ssh/ssl_key.pem_tmp'
-----
You are about to be asked to enter information that will be incorporated
into your certificate request.
What you are about to enter is what is called a Distinguished Name or a D
There are quite a few fields but you can leave some blank
For some fields there will be a default value,
If you enter '.', the field will be left blank.
-----
Country Name (2 letter code) [AU]:tw
State or Province Name (full name) [Some-State]:hs
Locality Name (eg, city) []:hschu
Organization Name (eg, company) [Internet Widgits Pty Ltd]:draytek
Organizational Unit Name (eg, section) []:marketing
Common Name (e.g. server FQDN or YOUR name) []:draytek
Email Address []:carrie_ni@draytek.com
P2121#

```

XI-2-17 Terminal Configuration

Use this command to set the maximum line number that the terminal is able to print.

Syntax Items

terminal

Syntax Description

Syntax Items	Description
<i>terminal</i>	<0-24> - Enter the length value. 0 means no limit. Related Syntax: <ul style="list-style-type: none">● # terminal length <0-24>

Example

```
P2121# terminal length 15
P2121# show running-config
.....
```

XI-2-18 Traceroute Configuration

Use this command to execute network trace route diagnostic.

Syntax Items

traceroute

Syntax Description

Syntax Items	Description
traceroute	<HOSTNAME>- Enter the IP address or the hostname of the device for VigorSwitch to perform traceroute diagnostic. Related Syntax: <ul style="list-style-type: none">● # traceroute <HOSTNAME>

Example

```
P2121# traceroute 192.168.1.224
traceroute to 192.168.1.224 (192.168.1.224), 30 hops max, 40 byte packets
 1 192.168.1.224 (192.168.1.224) 0 ms 0 ms 0 ms
P2121#
```

XI-2-19 UDLD Configuration

Use this command to reset all interfaces disabled by the UniDirectional Link Detection (UDLD) and make data traffic begin passing through the interfaces again.

Syntax Items

udld

Syntax Description

Syntax Items	Description
udld	Enter the IP address or the hostname of the device for VigorSwitch to perform traceroute diagnostic. Related Syntax: <ul style="list-style-type: none">● # udld reset

Example

```
P2121# udld reset
P2121#
```

This page is left blank.

Appendix: Reference

This chapter will tell you the basic concept of features to manage this switch and how they work.

A-1 What's the Ethernet

Ethernet originated and was implemented at Xerox in Palo Alto, CA in 1973 and was successfully commercialized by Digital Equipment Corporation (DEC), Intel and Xerox (DIX) in 1980. In 1992, Grand Junction Networks unveiled a new high speed Ethernet with the same characteristic of the original Ethernet but operated at 100Mbps, called Fast Ethernet now. This means Fast Ethernet inherits the same frame format, CSMA/CD, software interface. In 1998, Gigabit Ethernet was rolled out and provided 1000Mbps. Now 10G/s Ethernet is under approving. Although these Ethernet have different speed, they still use the same basic functions. So they are compatible in software and can connect each other almost without limitation. The transmission media may be the only problem.

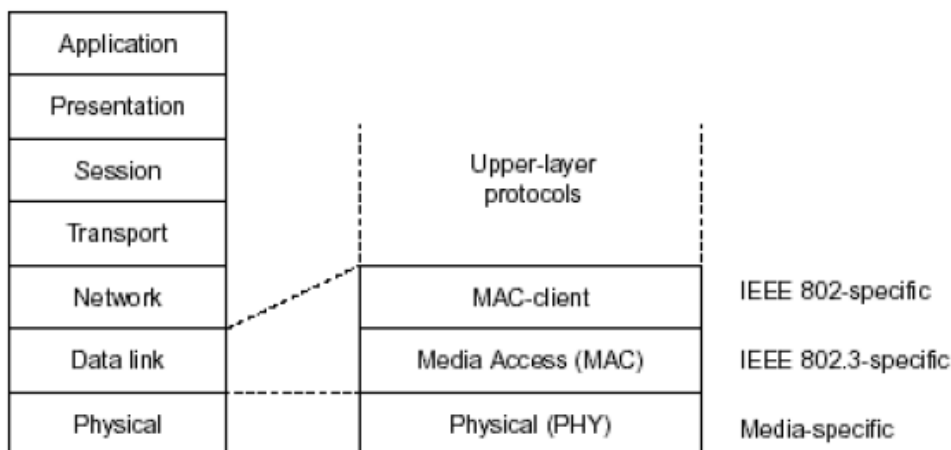

In the above figure, we can see that Ethernet locates at the Data Link layer and Physical layer and comprises three portions, including logical link control (LLC), media access control (MAC), and physical layer. The first two comprises Data link layer, which performs splitting data into frame for transmitting, receiving acknowledge frame, error checking and re-transmitting when not received correctly as well as provides an error-free channel upward to network layer.

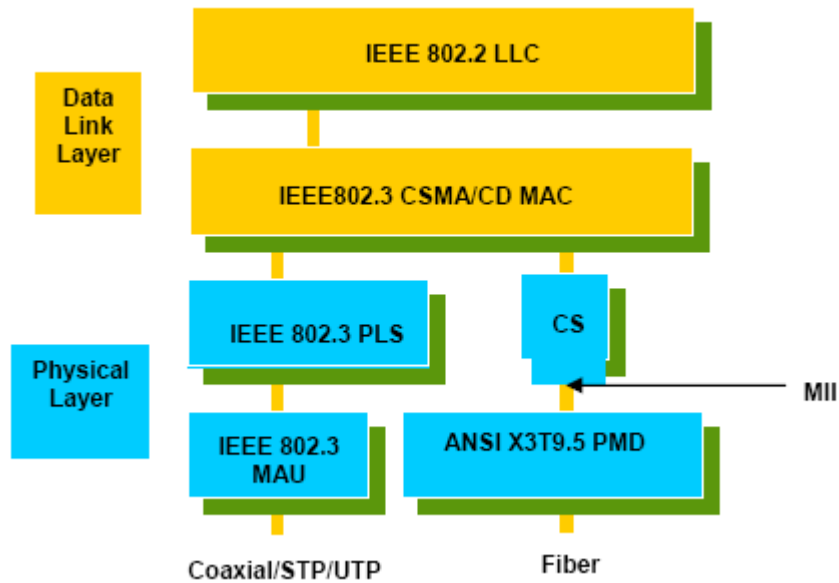

This above diagram shows the Ethernet architecture, LLC sub-layer and MAC sub-layer, which are responded to the Data Link layer, and transceivers, which are responded to the Physical layer in OSI model. In this section, we are mainly describing the MAC sub-layer.

Logical Link Control (LLC)

Data link layer is composed of both the sub-layers of MAC and MAC-client. Here MAC client may be logical link control or bridge relay entity.

Logical link control supports the interface between the Ethernet MAC and upper layers in the protocol stack, usually Network layer, which is nothing to do with the nature of the LAN. So it can operate over other different LAN technology such as Token Ring, FDDI and so on. Likewise, for the interface to the MAC layer, LLC defines the services with the interface independent of the medium access technology and with some of the nature of the medium itself.

DSAP address	SSAP address	Control	Information
8 bits	8 bits	8 or 16 bits	M*8 bits

- DSAP address = Destination service access point address field
- SSAP address = Source service access point address field
- Control = Control field [16 bits for formats that include sequence numbering, and 8 bits for formats that do not (see 5.2)]
- Information = Information field
- * = Multiplication
- M = An integer value equal to or greater than 0. (Upper bound of M is a function of the medium access control methodology used.)

The table above is the format of LLC PDU. It comprises four fields, DSAP, SSAP, Control and Information. The DSAP address field identifies the one or more service access points, in which the I/G bit indicates it is individual or group address. If all bit of DSAP is 1s, it's a global address. The SSAP address field identifies the specific services indicated by C/R bit (command or response). The DSAP and SSAP pair with some reserved values indicates some well-known services listed in the table below.

0xAAAA	SNAP
0xE0E0	Novell IPX
0xF0F0	NetBios
0xFEFE	IOS network layer PDU
0xFFFF	Novell IPX 802.3 RAW packet
0x4242	STP BPDU
0x0606	IP
0x9898	ARP

LLC type 1 connectionless service, LLC type 2 connection-oriented service and LLC type 3 acknowledge connectionless service are three types of LLC frame for all classes of service. In Fig 3-2, it shows the format of Service Access Point (SAP). Please refer to IEEE802.2 for more details.

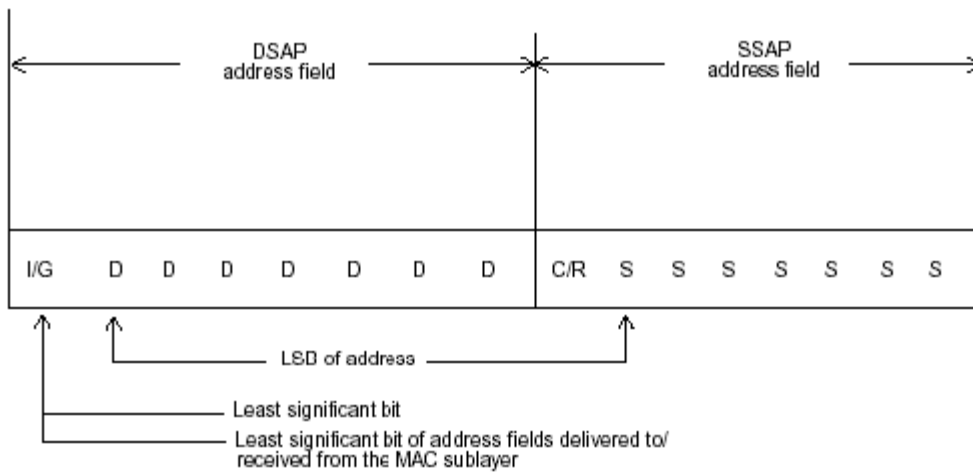

I/G = 0 Individual DSAP
I/G = 1 Group DSAP
C/R = 0 Command
C/R = 1 Response

XODDDDD DSAP address
XOSSSSS SSAP address

X1DDDDDD Reserved for ISO definition
X1SSSSSS Reserved for ISO definition

A-2 Media Access Control (MAC)

MAC Addressing

Because LAN is composed of many nodes, for the data exchanged among these nodes, each node must have its own unique address to identify who should send the data or should receive the data. In OSI model, each layer provides its own mean to identify the unique address in some form, for example, IP address in network layer.

The MAC is belonged to Data Link Layer (Layer 2), the address is defined to be a 48-bit long and locally unique address. Since this type of address is applied only to the Ethernet LAN media access control (MAC), they are referred to as MAC addresses.

The first three bytes are Organizational Unique Identifier (OUI) code assigned by IEEE. The last three bytes are the serial number assigned by the vendor of the network device. All these six bytes are stored in a non-volatile memory in the device. Their format is as the following table and normally written in the form as aa-bb-cc-dd-ee-ff, a 12 hexadecimal digits separated by hyphens, in which the aa-bb-cc is the OUI code and the dd-ee-ff is the serial number assigned by manufacturer.

Bit 47						Bit 0
1 st byte	2 nd byte	3 rd byte	4 th byte	5 th byte	6 th byte	
	OUI code			Serial number		

The first bit of the first byte in the Destination address (DA) determines the address to be a Unicast (0) or Multicast frame (1), known as I/G bit indicating individual (0) or group (1). So the 48-bit address space is divided into two portions, Unicast and Multicast. The second bit is for global-unique (0) or locally-unique address. The former is assigned by the device manufacturer, and the later is usually assigned by the administrator. In practice, global-unique addresses are always applied.

A unicast address is identified with a single network interface. With this nature of MAC address, a frame transmitted can exactly be received by the target an interface the destination MAC points to.

A multicast address is identified with a group of network devices or network interfaces. In Ethernet, a many-to-many connectivity in the LANs is provided. It provides a mean to send a frame to many network devices at a time. When all bit of DA is 1s, it is a broadcast, which means all network device except the sender itself can receive the frame and response.

Ethernet Frame Format

There are two major forms of Ethernet frame, type encapsulation and length encapsulation, both of which are categorized as four frame formats 802.3/802.2 SNAP, 802.3/802.2, Ethernet II and Netware 802.3 RAW. We will introduce the basic Ethernet frame format defined by the IEEE 802.3 standard required for all MAC implementations. It contains seven fields explained below.

PRE	SFD	DA	SA	Type/Length	Data	Pad bit if any	FCS
7	7	6	6	2		46-1500	4

Preamble (PRE) - The PRE is 7-byte long with alternating pattern of ones and zeros used to tell the receiving node that a frame is coming, and to synchronize the physical receiver with the incoming bit stream. The preamble pattern is:

10101010 10101010 10101010 10101010 10101010 10101010 10101010

Start-of-frame delimiter (SFD) - The SFD is one-byte long with alternating pattern of ones and zeros, ending with two consecutive 1-bits. It immediately follows the preamble and uses the last two consecutive 1s bit to indicate that the next bit is the start of the data packet and the left-most bit in the left-most byte of the destination address. The SFD pattern is 10101011.

Destination address (DA) - The DA field is used to identify which network device(s) should receive the packet. It is a unique address. Please see the section of MAC addressing.

Source addresses (SA) - The SA field indicates the source node. The SA is always an individual address and the left-most bit in the SA field is always 0.

Length/Type - This field indicates either the number of the data bytes contained in the data field of the frame, or the Ethernet type of data. If the value of first two bytes is less than or equal to 1500 in decimal, the number of bytes in the data field is equal to the Length/Type value, i.e. this field acts as Length indicator at this moment. When this field acts as Length, the frame has optional fields for 802.3/802.2 SNAP encapsulation, 802.3/802.2 encapsulation and Netware 802.3 RAW encapsulation. Each of them has different fields following the Length field.

If the Length/Type value is greater than 1500, it means the Length/Type acts as Type. Different type value means the frames with different protocols running over Ethernet being sent or received.

For example,

0x0800	IP datagram
0x0806	ARP
0x0835	RARP
0x8137	IPX datagram
0x86DD	IPv6

Data - Less than or equal to 1500 bytes and greater or equal to 46 bytes. If data is less than 46 bytes, the MAC will automatically extend the padding bits and have the payload be equal to 46 bytes. The length of data field must equal the value of the Length field when the Length/Type acts as Length.

Frame check sequence (FCS) - This field contains a 32-bit cyclic redundancy check (CRC) value, and is a check sum computed with DA, SA, through the end of the data field with the following polynomial.

$$G(x) = x^{32} + x^{26} + x^{23} + x^{22} + x^{16} + x^{12} + x^{11} + x^{10} + x^8 + x^7 + x^5 + x^4 + x^2 + x + 1$$

It is created by the sending MAC and recalculated by the receiving MAC to check if the packet is damaged or not.

How does a MAC work?

The MAC sub-layer has two primary jobs to do:

1. Receiving and transmitting data. When receiving data, it parses frame to detect error; when transmitting data, it performs frame assembly.
2. Performing Media access control. It prepares the initiation jobs for a frame transmission and makes recovery from transmission failure.

Frame transmission

As Ethernet adopted Carrier Sense Multiple Access with Collision Detect (CSMA/CD), it detects if there is any carrier signal from another network device running over the physical medium when a frame is ready for transmission. This is referred to as sensing carrier, also "Listen". If

there is signal on the medium, the MAC defers the traffic to avoid a transmission collision and waits for a random period of time, called backoff time, then sends the traffic again.

After the frame is assembled, when transmitting the frame, the preamble (PRE) bytes are inserted and sent first, then the next, Start of frame Delimiter (SFD), DA, SA and through the data field and FCS field in turn. The followings summarize what a MAC does before transmitting a frame.

1. MAC will assemble the frame. First, the preamble and Start-of-Frame delimiter will be put in the fields of PRE and SFD, followed DA, SA, tag ID if tagged VLAN is applied, Ethertype or the value of the data length, and payload data field, and finally put the FCS data in order into the responded fields.
2. Listen if there is any traffic running over the medium. If yes, wait.
3. If the medium is quiet, and no longer senses any carrier, the MAC waits for a period of time, i.e. inter-frame gap time to have the MAC ready with enough time and then start transmitting the frame.
4. During the transmission, MAC keeps monitoring the status of the medium. If no collision happens until the end of the frame, it transmits successfully. If there is a collision happened, the MAC will send the patterned jamming bit to guarantee the collision event propagated to all involved network devices, then wait for a random period of time, i.e. backoff time. When backoff time expires, the MAC goes back to the beginning state and attempts to transmit again. After a collision happens, MAC increases the transmission attempts. If the count of the transmission attempt reaches 16 times, the frame in MAC's queue will be discarded.

Ethernet MAC transmits frames in half-duplex and full-duplex ways. In halfduplex operation mode, the MAC can either transmit or receive frame at a moment, but cannot do both jobs at the same time.

As the transmission of a MAC frame with the half-duplex operation exists only in the same collision domain, the carrier signal needs to spend time to travel to reach the targeted device. For two most-distant devices in the same collision domain, when one sends the frame first, and the second sends the frame, in worstcase, just before the frame from the first device arrives. The collision happens and will be detected by the second device immediately. Because of the medium delay, this corrupted signal needs to spend some time to propagate back to the first device. The maximum time to detect a collision is approximately twice the signal propagation time between the two most-distant devices. This maximum time is traded-off by the collision recovery time and the diameter of the LAN.

In the original 802.3 specification, Ethernet operates in half duplex only. Under this condition, when in 10Mbps LAN, it's 2500 meters, in 100Mbps LAN, it's approximately 200 meters and in 1000Mbps, 200 meters. According to the theory, it should be 20 meters. But it's not practical, so the LAN diameter is kept by using to increase the minimum frame size with a variable-length non-data extension bit field which is removed at the receiving MAC. The following tables are the frame format suitable for 10M, 100M and 1000M Ethernet, and some parameter values that shall be applied to all of these three types of Ethernet.

Actually, the practice Gigabit Ethernet chips do not feature this so far. They all have their chips supported full-duplex mode only, as well as all network vendors' devices. So this criterion should not exist at the present time and in the future. The switch's Gigabit module supports only full-duplex mode.

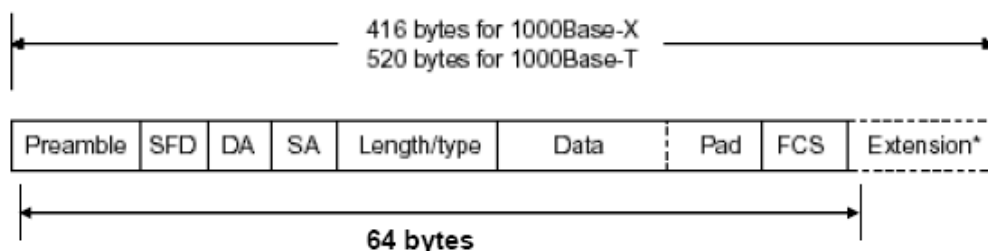

Parameter value/LAN	10Base	100Base	1000Base
Max. collision domain DTE to DTE	100 meters	100 meters for UTP 412 meters for fiber	100 meters for UTP 316 meters for fiber
Max. collision domain with repeater	2500 meters	205 meters	200 meters
Slot time	512 bit times	512 bit times	512 bit times
Interframe Gap	9.6us	0.96us	0.096us
AttemptLimit	16	16	16
BackoffLimit	10	10	10
JamSize	32 bits	32 bits	32 bits
MaxFrameSize	1518	1518	1518
MinFrameSize	64	64	64
BurstLimit	Not applicable	Not applicable	65536 bits

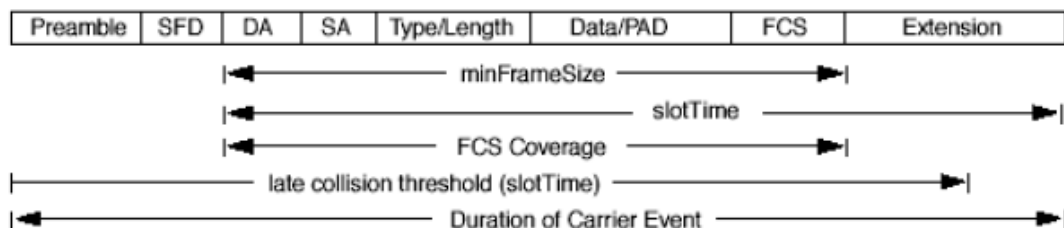

In full-duplex operation mode, both transmitting and receiving frames are processed simultaneously. This doubles the total bandwidth. Full duplex is much easier than half duplex because it does not involve media contention, collision, retransmission schedule, padding bits for short frame. The rest functions follow the specification of IEEE802.3. For example, it must meet the requirement of minimum inter-frame gap between successive frames and frame format the same as that in the half-duplex operation.

Because no collision will happen in full-duplex operation, for sure, there is no mechanism to tell all the involved devices. What will it be if receiving device is busy and a frame is coming at the same time? Can it use "backpressure" to tell the source device? A function flow control is introduced in the full-duplex operation.

A-3 Flow Control

Flow control is a mechanism to tell the source device stopping sending frame for a specified period of time designated by target device until the PAUSE time expires. This is accomplished by sending a PAUSE frame from target device to source device. When the target is not busy and the PAUSE time is expired, it will send another PAUSE frame with zero time-to-wait to source device. After the source device receives the PAUSE frame, it will again transmit frames immediately. PAUSE frame is identical in the form of the MAC frame with a pause-time value and with a special destination MAC address 01-80-C2-00-00-01. As per the specification, PAUSE operation can not be used to inhibit the transmission of MAC control frame.

Normally, in 10Mbps and 100Mbps Ethernet, only symmetric flow control is supported. However, some switches (e.g. 24-Port GbE Web Smart Switch) support not only symmetric but asymmetric flow controls for the special application. In Gigabit Ethernet, both symmetric flow control and asymmetric flow control are supported. Asymmetric flow control only allows transmitting PAUSE frame in one way from one side, the other side is not but receipt-and-discard the flow control information. Symmetric flow control allows both two ports to transmit PASUE frames each other simultaneously.

Inter-frame Gap time

After the end of a transmission, if a network node is ready to transmit data out and if there is no carrier signal on the medium at that time, the device will wait for a period of time known as an inter-frame gap time to have the medium clear and stabilized as well as to have the jobs ready, such as adjusting buffer counter, updating counter and so on, in the receiver site. Once the inter-frame gap time expires after the de-assertion of carrier sense, the MAC transmits data. In IEEE802.3 specification, this is 96-bit time or more.

Collision

Collision happens only in half-duplex operation. When two or more network nodes transmit frames at approximately the same time, a collision always occurs and interferes with each other. This results the carrier signal distorted and undiscriminated. MAC can afford detecting, through the physical layer, the distortion of the carrier signal. When a collision is detected during a frame transmission, the transmission will not stop immediately but, instead, continues transmitting until the rest bits specified by jamSize are completely transmitted. This guarantees the duration of collision is enough to have all involved devices able to detect the collision. This is referred to as Jamming. After jamming pattern is sent, MAC stops transmitting the rest data queued in the buffer and waits for a random period of time, known as backoff time with the following formula. When backoff time expires, the device goes back to the state of attempting to transmit frame. The backoff time is determined by the formula below. When the times of collision is increased, the backoff time is getting long until the collision times excess 16. If this happens, the frame will be discarded and backoff time will also be reset.

$$0 \leq r < 2^k$$

where

$$k = \min(n, 10)$$

Frame Reception

In essence, the frame reception is the same in both operations of half duplex and full duplex, except that full-duplex operation uses two buffers to transmit and receive the frame independently. The receiving node always "listens" if there is traffic running over the medium when it is not receiving a frame. When a frame destined for the target device comes,

the receiver of the target device begins receiving the bit stream, and looks for the PRE (Preamble) pattern and Start-of-Frame Delimiter (SFD) that indicates the next bit is the starting point of the MAC frame until all bit of the frame is received.

For a received frame, the MAC will check:

1. If it is less than one slotTime in length, i.e. short packet, and if yes, it will be discarded by MAC because, by definition, the valid frame must be longer than the slotTime. If the length of the frame is less than one slotTime, it means there may be a collision happened somewhere or an interface malfunctioned in the LAN. When detecting the case, the MAC drops the packet and goes back to the ready state.
2. If the DA of the received frame exactly matches the physical address that the receiving MAC owns or the multicast address designated to recognize. If not, discards it and the MAC passes the frame to its client and goes back to the ready state.
3. If the frame is too long. If yes, throws it away and reports frame Too Long.
4. If the FCS of the received frame is valid. If not, for 10M and 100M Ethernet, discards the frame. For Gigabit Ethernet or higher speed Ethernet, MAC has to check one more field, i.e. extra bit field, if FCS is invalid. If there is any extra bits existed, which must meet the specification of IEEE802.3. When both FCS and extra bits are valid, the received frame will be accepted, otherwise discards the received frame and reports frameCheckError if no extra bits appended or alignmentError if extra bits appended.
5. If the length/type is valid. If not, discards the packet and reports lengthError.
6. If all five procedures above are ok, then the MAC treats the frame as good and de-assembles the frame.

What if a VLAN tagging is applied?

VLAN tagging is a 4-byte long data immediately following the MAC source address. When tagged VLAN is applied, the Ethernet frame structure will have a little change shown as follows.

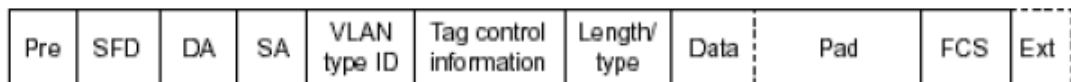

Only two fields, VLAN ID and Tag control information are different in comparison with the basic Ethernet frame. The rest fields are the same.

The first two bytes is VLAN type ID with the value of 0x8100 indicating the received frame is tagged VLAN and the next two bytes are Tag Control Information (TCI) used to provide user priority and VLAN ID, which are explained respectively in the following table.

Bits 15-13	User Priority 7-0, 0 is lowest priority
Bit 12	CFI (Canonical Format Indicator) 1: RIF field is present in the tag header 0: No RIF field is present
Bits 11-0	VID (VLAN Identifier) 0x000: Null VID. No VID is present and only user priority is present. 0x001: Default VID 0xFFF: Reserved

Note: RIF is used in Token Ring network to provide source routing and comprises two fields, Routing Control and Route Descriptor.

When MAC parses the received frame and finds a reserved special value 0x8100 at the location of the Length/Type field of the normal non-VLAN frame, it will interpret the received frame as a tagged VLAN frame. If this happens in a switch, the MAC will forward it, according to its priority and egress rule, to all the ports that is associated with that VID. If it happens in a

network interface card, MAC will be deprived of the tag header and process it in the same way as a basic normal frame. For a VLAN-enabled LAN, all involved devices must be equipped with VLAN optional function.

At operating speeds above 100 Mbps, the slotTime employed at slower speeds is inadequate to accommodate network topologies of the desired physical extent. Carrier Extension provides a means by which the slotTime can be increased to a sufficient value for the desired topologies, without increasing the minFrameSize parameter, as this would have deleterious effects. Nondata bits, referred to as extension bits, are appended to frames that are less than slotTime bits in length so that the resulting transmission is at least one slotTime in duration. Carrier Extension can be performed only if the underlying physical layer is capable of sending and receiving symbols that are readily distinguished from data symbols, as is the case in most physical layers that use a block encoding/decoding scheme.

The maximum length of the extension is equal to the quantity (slotTime - minFrameSize). The MAC continues to monitor the medium for collisions while it is transmitting extension bits, and it will treat any collision that occurs after the threshold (slotTime) as a late collision.

Index

- Account Manager, 207, 208
- Backup Manager, 205
- Bandwidth, 169
- CoS Mapping, 166
- Dashboard, 22, 23
- Diagnostics, 211, 221
- DoS, 129
- DoS Port Setting, 131
- DoS Protection, 131
- Egress Shaping Per Queue, 171
- Egress Shaping Rate, 170
- Factory Default, 209
- General, 150, 153, 159, 162
- General Setup, 26
- Ingress Rate Limit, 169
- Installation for VigorAPM, 7
- License Agreement, 28
- License Information, 31, 32, 38, 55, 56, 81, 82, 91
- Limiting Rate, 128
- PoE Configuration, 173
- Preamble, 127
- Properties, 129
- QoS Configuration, 149, 161
- Security, 95, 109
- SNMP, 191
- SNMP Community, 194, 195, 197
- Storm Control, 128
- Storm Control, 96, 110, 112, 113, 115, 118, 125, 127
- Storm Control, 132
- Storm Control, 135
- Storm Control, 141
- Stric Priority Queue, 165
- System Configuration, 25
- System Maintenance, 179
- Upgrade Manager, 206
- Weight, 165
- WRR Bandwidth, 165